

marantz[®]

AV Surround Receiver

NR1604

Owner's Manual

SAFETY PRECAUTIONS



CAUTION
RISK OF ELECTRIC SHOCK
DO NOT OPEN



CAUTION:
TO REDUCE THE RISK OF ELECTRIC SHOCK, DO NOT REMOVE COVER (OR BACK). NO USER-SERVICEABLE PARTS INSIDE. REFER SERVICING TO QUALIFIED SERVICE PERSONNEL.

The lightning flash with arrowhead symbol, within an equilateral triangle, is intended to alert the user to the presence of uninsulated "dangerous voltage" within the product's enclosure that may be of sufficient magnitude to constitute a risk of electric shock to persons.

The exclamation point within an equilateral triangle is intended to alert the user to the presence of important operating and maintenance (servicing) instructions in the literature accompanying the appliance.

WARNING:
TO REDUCE THE RISK OF FIRE OR ELECTRIC SHOCK, DO NOT EXPOSE THIS APPLIANCE TO RAIN OR MOISTURE.



Hot surface mark

CAUTION:
HOT SURFACE. DO NOT TOUCH.

The top surface over the internal heat sink may become hot when operating this product continuously. Do not touch hot areas, especially around the "Hot surface mark" and the top panel.

IMPORTANT SAFETY INSTRUCTIONS

1. Read these instructions.
2. Keep these instructions.
3. Heed all warnings.
4. Follow all instructions.
5. Do not use this apparatus near water.
6. Clean only with dry cloth.
7. Do not block any ventilation openings. Install in accordance with the manufacturer's instructions.
8. Do not install near any heat sources such as radiators, heat registers, stoves, or other apparatus (including amplifiers) that produce heat.
9. Do not defeat the safety purpose of the polarized or grounding-type plug. A polarized plug has two blades with one wider than the other. A grounding type plug has two blades and a third grounding prong. The wide blade or the third prong are provided for your safety. If the provided plug does not fit into your outlet, consult an electrician for replacement of the obsolete outlet.
10. Protect the power cord from being walked on or pinched particularly at plugs, convenience receptacles, and the point where they exit from the apparatus.
11. Only use attachments/accessories specified by the manufacturer.
12. Use only with the cart, stand, tripod, bracket, or table specified by the manufacturer, or sold with the apparatus. When a cart is used, use caution when moving the cart/apparatus combination to avoid injury from tip-over.
13. Unplug this apparatus during lightning storms or when unused for long periods of time.
14. Refer all servicing to qualified service personnel. Servicing is required when the apparatus has been damaged in any way, such as power-supply cord or plug is damaged, liquid has been spilled or objects have fallen into the apparatus, the apparatus has been exposed to rain or moisture, does not operate normally, or has been dropped.
15. Batteries shall not be exposed to excessive heat such as sunshine, fire or the like.



CAUTION:

To completely disconnect this product from the mains, disconnect the plug from the wall socket outlet. The mains plug is used to completely interrupt the power supply to the unit and must be within easy access by the user.

FCC INFORMATION (For US customers)

1. COMPLIANCE INFORMATION

Product Name: AV Surround Receiver
Model Number: NR1604
This product complies with Part 15 of the FCC Rules. Operation is subject to the following two conditions: (1) this product may not cause harmful interference, and (2) this product must accept any interference received, including interference that may cause undesired operation.
Marantz America, LLC.
(a D&M Holdings Company)
100 Corporate Drive,
Mahwah, NJ, 07430, U.S.A.
Tel. 201-762-6500

2. IMPORTANT NOTICE: DO NOT MODIFY THIS PRODUCT

This product, when installed as indicated in the instructions contained in this manual, meets FCC requirements. Modification not expressly approved by Marantz may void your authority, granted by the FCC, to use the product.

3. IMPORTANT

When connecting this product to network hub or router, use only a shielded STP or ScTP LAN cable which is available at retailer. Follow all installation instructions. Failure to follow instructions could void your authority, granted by the FCC, to use the product.

4. NOTE

This product has been tested and found to comply with the limits for a Class B digital device, pursuant to Part 15 of the FCC Rules. These limits are designed to provide reasonable protection against harmful interference in a residential installation.

This product generates, uses and can radiate radio frequency energy and, if not installed and used in accordance with the instructions, may cause harmful interference to radio communications. However, there is no guarantee that interference will not occur in a particular installation. If this product does cause harmful interference to radio or television reception, which can be determined by turning the product OFF and ON, the user is encouraged to try to correct the interference by one or more of the following measures:

- Reorient or relocate the receiving antenna.
- Increase the separation between the equipment and receiver.
- Connect the product into an outlet on a circuit different from that to which the receiver is connected.
- Consult the local retailer authorized to distribute this type of product or an experienced radio/TV technician for help.

For Canadian customers:

This Class B digital apparatus complies with Canadian ICES-003.

☐ NOTES ON USE

WARNINGS

- Avoid high temperatures.
Allow for sufficient heat dispersion when installed in a rack.
- Handle the power cord carefully.
Hold the plug when unplugging the cord.
- Keep the unit free from moisture, water, and dust.
- Unplug the power cord when not using the unit for long periods of time.
- Do not obstruct the ventilation holes.
- Do not let foreign objects into the unit.
- Do not let insecticides, benzene, and thinner come in contact with the unit.
- Never disassemble or modify the unit in any way.
- Ventilation should not be impeded by covering the ventilation openings with items, such as newspapers, tablecloths or curtains.
- Naked flame sources such as lighted candles should not be placed on the unit.
- Observe and follow local regulations regarding battery disposal.
- Do not expose the unit to dripping or splashing fluids.
- Do not place objects filled with liquids, such as vases, on the unit.
- Do not handle the mains cord with wet hands.
- When the switch is in the OFF (STANDBY) position, the equipment is not completely switched off from MAINS.
- The equipment shall be installed near the power supply so that the power supply is easily accessible.
- Do not keep the battery in a place exposed to direct sunlight or in places with extremely high temperatures, such as near a heater.

☐ CAUTIONS ON INSTALLATION

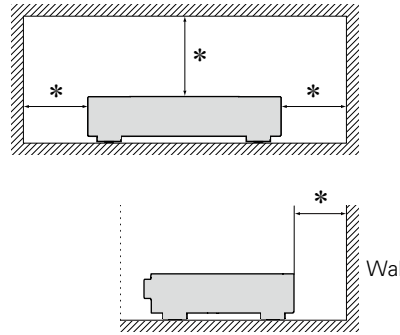

*** For proper heat dispersal, do not install this unit in a confined space, such as a bookcase or similar enclosure.**

- More than 12 in. (0.3 m) is recommended.

Getting started

Thank you for purchasing this Marantz product. To ensure proper operation, please read this owner's manual carefully before using the product. After reading this manual, be sure to keep it for future reference.

Contents

Getting started	1
Accessories	2
Features	2
Cautions on handling	3

Basic instructions

Connections	5
Important information	5
Connecting HDMI devices	7
Connecting other devices	12
Connecting to a home network (LAN)	20
Connecting the power cord	21
Setup	22
Set up speakers (Audyssey® Setup)	22
Making the network settings (Network)	28
Playback (Basic operation)	29
Important information	29
Playing a Blu-ray Disc player/DVD player	30
Playing a CD player	30
Playing an iPod	31
Playing a USB memory device	34
Listening to FM/AM broadcasts	37
Network content	46
Listening to Internet Radio	46
Playing back files stored on a PC and NAS	49
Using online services	53
Convenient functions	64
AirPlay function	70
Selecting a listening mode (Sound Mode)	72
Selecting a listening mode	72

Advanced instructions

Installation/connection/setup of speakers (Advanced)	79
Speaker installation	79
Speaker connection	81
Set up speakers	91
Connections (Advanced connection)	93
Connecting the REMOTE CONTROL connectors	93
Connecting an external control device	94
Playback (Advanced operation)	95
HDMI control function	95
Sleep timer function	96
Web control function	97
Dual backup memory function	99
Panel lock function	99
Remote lock function	100
Various memory functions	100
Playback in ZONE2 (Separate room)	101
Audio output	101
Playback	101
Sleep timer function	102
How to make detailed settings	103
Menu map	103
Examples of menu screen displays	105
Examples of menu and front display	106
Inputting characters	107
Audio	108
Video	114
Inputs	119
Speakers	123
Network	127
General	131

Information

Part names and functions	138
Front panel	138
Display	139
Rear panel	140
Remote control unit	141
Other information	143
Trademark information	143
Surround	144
Relationship between video signals and monitor output	148
Explanation of terms	150
Troubleshooting	153
Resetting the microprocessor	157
Specifications	158

Accessories

Check that the following parts are supplied with the product.

① Getting Started	1
② CD-ROM (Owner's Manual)	1
③ Safety Instructions	1
④ Warranty card (for USA)	1
⑤ Warranty card (for CANADA)	1
⑥ Power cord	1
⑦ Remote control unit (RC021SR)	1
⑧ R03/AAA batteries	2
⑨ AM loop antenna	1
⑩ FM indoor antenna	1
⑪ Setup and measurement microphone (ACM1HB)	1
⑫ Cable label	1

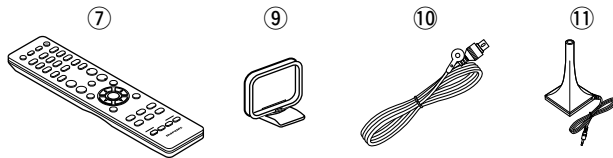

Features

Digital video processor upscales analog video signals (SD resolution) to HD (720p/1080p) and 4K

This unit features a sophisticated video processor that can upscale standard definition (SD) analog video content from legacy sources such as a VCR to HD and is able to output at 4K resolution (3840 x 2160 pixels) for compatibility with newly available resolution 4K TVs.

With discrete circuit technology, the power amplifier provides identical quality for all 7 channels (50 Watts x 7 channels)

For optimum realism and stunning dynamic range, the power amplifier section features discrete power devices (not integrated circuitry).

By using high current, high power discrete power devices, the amplifier is able to easily drive high quality speakers.

Supports Internet Radio, music, and photograph streaming

Supports AirPlay® (👉 page 70)

You can enjoy a wide variety of content, including listening to Internet Radio, playing audio files stored on your PC, and displaying photographs stored on your PC on our television.

This unit also supports Apple AirPlay which lets you stream your music library from an iPhone®, iPad®, iPod touch® or iTunes®.

Compatible with “Marantz Remote App” for performing basic operations of the unit with an iPad, iPhone* or Android smartphone

“Marantz Remote App” is application software that allows you to perform basic operations with an iPad, iPhone, Android smartphone or Android tablet such as turning the unit ON/OFF, controlling the volume, and switching the source.

* Download the appropriate “Marantz Remote App” for iOS and Android devices. This unit needs to be connected to your LAN and the iPhone/iPod touch or other device needs to be connected to the same network by Wi-Fi (wireless LAN).

“Setup Assistant” provides easy-to-follow setup instructions

First select the language when prompted. Then simply follow the instructions displayed on the TV screen to set up the speakers, network, etc.

Easy to use Graphical User Interface

This unit is equipped with an easy to see Graphical User Interface that uses menu displays and features colorful icons and easy to understand controls for maximum ease of use.

HDMI connections enable quick connection to various digital AV devices (7 inputs, 1 output)

The unit is equipped with 7 HDMI input connectors for connecting devices with HDMI connectors, such as a Blu-ray Disc player, game console, HD digital camcorder, HDTVs, etc.

Supports HDMI (3D, ARC, Deep Color, "x.v.Color", Auto Lip Sync, 4K) and HDMI control function (👉 [page 7](#))

Advanced HDMI features are supported, including 3D passthrough, Audio Return Channel, Auto Lip Sync, Deep Color and "x.v.Color", and HDMI CEC control functions. If a 4K digital video signal is input, it is passed through the unit unchanged, and the GUI overlay will adjust the resolution accordingly.

Direct play for iPod and iPhone via USB (👉 [page 16](#))

Music data from an iPod or iPhone can be played back if you connect the USB cable supplied with the iPod via the USB port of this unit, and also an iPod can be controlled with the remote control that comes with this unit.

Multi-Room audio

Enjoy audio playback in your home theater and another room at the same time.

M-XPort (Marantz-eXtension Port) (👉 [page 19](#))

This unit is equipped with the M-XPort, a Marantz original innovation that provides outstanding expandability. You can connect the Wireless Receiver RX101 (sold separately) to this port.

Cautions on handling

- **Before turning the power on**

Check once again that all connections are correct and that there are no problems with the connection cables.

- Power is supplied to some of the circuitry even when the unit is set to the standby mode. When going on vacation or leaving home for long periods of time, be sure to unplug the power cord from the power outlet.

- **About condensation**

If there is a major difference in temperature between the inside of the unit and the surroundings, condensation (dew) may form on the operating parts inside the unit, causing the unit not to operate properly.

If this happens, let the unit sit for an hour or two with the power turned off and wait until there is little difference in temperature before using the unit.

- **Cautions on using mobile phones**

Using a mobile phone near this unit may result in noise. If that occurs, move the mobile phone away from this unit when it is in use.

- **Moving the unit**





Turn off the power and unplug the power cord from the power outlet. Next, disconnect the connection cables to other system units before moving the unit.

- **About care**

- Wipe the cabinet and control panel clean with a soft cloth.
- Follow the instructions when using a chemical cleaner.
- Benzene, paint thinner or other organic solvents as well as insecticide may cause material changes and discoloration if brought into contact with the unit, and should therefore not be used.

Basic instructions

Here we explain the connections and basic operation methods for this unit.

- **Connections**  [page 5](#)
- **Setup**  [page 22](#)
- **Playback (Basic operation)**  [page 29](#)
- **Network content**  [page 46](#)
- **Selecting a listening mode (Sound Mode)**  [page 72](#)

For speaker connections, see [page 81](#).















Connections

Important information

Make connections before using this unit.





















To create a home theater that can play back higher quality video and audio by fully utilizing the capabilities of this unit and your video devices, connect this unit to each of your video devices with HDMI cables.

□ HDMI devices

 TV  page 9	 CBL/SAT  page 10	 DVD  page 10
 Blu-ray  page 10	 GAME  page 10	 MEDIA PLAYER  page 10
 AUX  page 10		

If your video device does not support HDMI connections, use the following connection.



□ Other devices

 TV  page 13	 CBL/SAT  page 14	 DVD  page 15
 iPod/USB  page 16	 CD  page 17	 TUNER  page 18
 M-XPoort  page 19	 NETWORK  page 20	 SPEAKER  page 81
 AC IN  page 21		

This unit can change the source that is assigned to the DIGITAL AUDIO IN, ANALOG AUDIO IN, COMPONENT VIDEO IN and VIDEO IN connectors.

For details on assigning a source to connectors, see “Changing the source assigned to connectors” ( [page 12](#)). For the setting method, see “Input Assign” ( [page 120](#)).

NOTE

- When video signals are being upscaled to 4K output resolution, the menu screen is only displayed on a 4K display that is connected to this unit via HDMI.
- Do not plug in the power cord until all connections have been completed. However, when the “Setup Assistant” is running, follow the instructions in the “Setup Assistant” ( page 7) screen for making connections. (During “Setup Assistant” operation, the input/output connectors do not conduct current.)
- When running the “Setup Assistant” ( page 7), turn off the power supply of connected devices.
- When making connections, also refer to the operating instructions of the other devices being connected.
- Be sure to connect the left and right channels properly (left with left, right with right).
- Do not bundle power cords together with connection cables. Doing so can result in noise.

Converting input video signals for HD output (Video conversion function)

This unit is equipped with three types of video input connectors (HDMI, component video and composite video) and three types of video output connectors (HDMI, component video and composite video).

This function automatically converts various formats of video signals input to this unit into the formats used to output the video signals from this unit to a monitor.

[Flow of video signals for the MAIN ZONE]

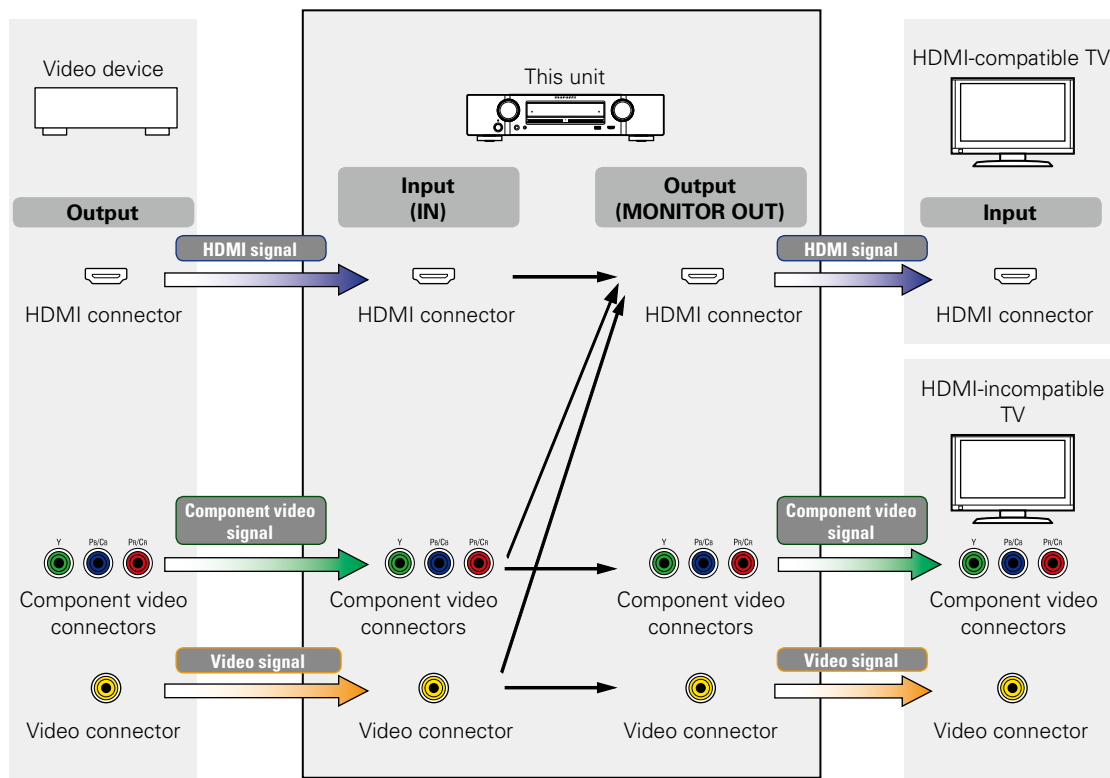

For maximum flexibility with different video signal types and resolutions, this unit provides two important video processing functions. First, it can convert standard definition composite video to digital HDMI. It also provides video upscaling from standard definition to high definition resolutions, supporting 720p and 1080p HD outputs via HDMI, including 4K. If you have older legacy video sources such as a VCR and/or an analog video camcorder, connect via the composite video connectors (yellow jacks). If you have an older DVD or HD player that is not equipped with HDMI output but is equipped with component video output, connect the player to the unit's component video input. Pay attention to the component video connection (it's a three wire connection) so as to ensure that the jacks on the player match the component video input jacks on this unit, otherwise you may not see a picture, or the picture will have distorted colors.

Make Settings as Necessary

- If you do not want this unit to convert video signals automatically, use the following setting item to disable this function.
"Video Conversion" (page 116)
- If you want to change the resolution of video signals output to the TV, use the following setting item to do so.
"Resolution" (page 117)



- The video conversion function supports the NTSC, PAL, SECAM, NTSC 4.43, PAL-N, PAL-M and PAL-60 formats.
- Resolutions of HDMI-compatible TVs can be checked at "Video" – "HDMI Monitor" (page 134).

NOTE

- When a non-standard video signal from a game console or some other source is input, the video conversion function might not operate.
- HDMI signals cannot be converted into analog signals (page 148).

Connecting HDMI devices

You can connect up to eight HDMI-compatible devices (7-inputs/1-output) to the unit.

If the device connected to this unit is equipped with an HDMI connector, it is recommended to use HDMI connections. Connections with an HDMI cable offer the following benefits that can not be achieved with other connection methods.

- **High quality playback by transmitting audio and video via digital signals**

HDMI connections can transmit high definition video and high quality audio formats adopted by Blu-ray disc players (Dolby Digital Plus, Dolby TrueHD, dts-HD, dts-HD Master Audio).

HDMI connections also convey information required for playback between devices. The information is used for copyright protection and TV resolution recognition, the ARC function, the HDMI control function, etc.

- **Transmission of audio and video signals with a single HDMI cable**

Previous connections required multiple audio and video cables, but HDMI connections require only a single HDMI cable to transmit audio and video signals. This allows wires in a home theater system, which tend to be complicated, to be more easily organized.

- **Mutual control through the HDMI control function** (👉 [page 95](#))

This unit and the HDMI device connected via HDMI can be linked to perform operations such as power control, volume control, and input source switching.

- **Other video and audio functions, such as 3D video playback, Content Type, the ARC function, are supported** (👉 [page 11](#)).



- There is more than one version of the HDMI standard. The supported functions and the performance vary according to the version. This unit complies with the HDMI standard that supports the ARC and 3D playback functions. To enjoy these functions, the HDMI device connected to this unit also needs to use the same version of the standard. For the version of the HDMI standard on the device connected to this unit, see the device's manual.
- Some TVs do not support audio input via HDMI connections. For details, see your TV's manual.

❑ **Before connecting this unit to TV via HDMI connections** (👉 [page 8](#))

❑ **Connecting this unit to a TV via HDMI connections** (👉 [page 9](#))

❑ **Connecting this unit to video devices via HDMI connections** (👉 [page 10](#))

❑ **HDMI function** (👉 [page 11](#))

❑ **Settings related to HDMI connections** (👉 [page 11](#))

Before connecting this unit to TV via HDMI connections

There are 2 methods to connect an HDMI-compatible TV to this unit.
Use the connection method that suits your TV.

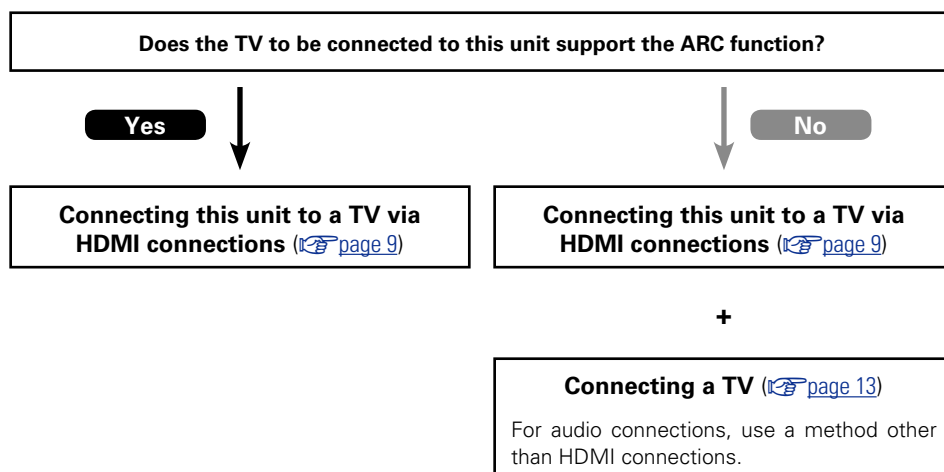

About ARC (Audio Return Channel) function

This function plays TV audio on this unit by sending the TV audio signal to this unit via the HDMI cable. If a TV without the ARC function is connected via HDMI connections, video signals of the playback device connected to this unit are transmitted to the TV, but this unit can not play back the audio from the TV. If you want to enjoy surround audio for TV program, a separate audio cable connection is required.

In contrast, if a TV with the ARC function is connected via HDMI connections, no audio cable connection is required. Audio signals from the TV can be input to this unit through the HDMI cable between this unit and the TV. This function allows you to enjoy surround playback on this unit for the TV.



When the ARC function is used, connect a device with a "Standard HDMI cable with Ethernet" or "High Speed HDMI cable with Ethernet" for HDMI. Refer to the owner's manual for your TV for details about TV connection and settings.

[Connection to a TV with the ARC function]

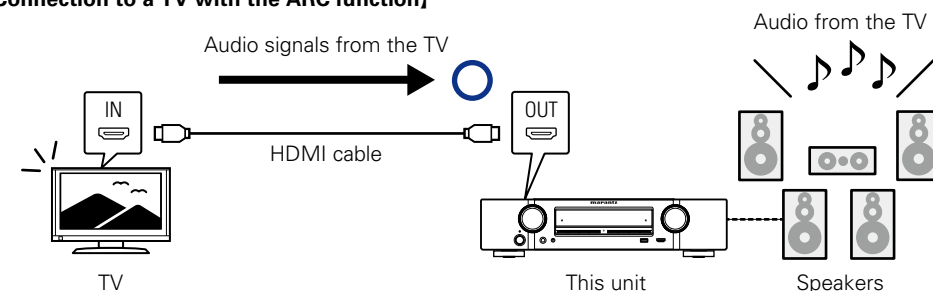

[Connection to a TV without the ARC function]

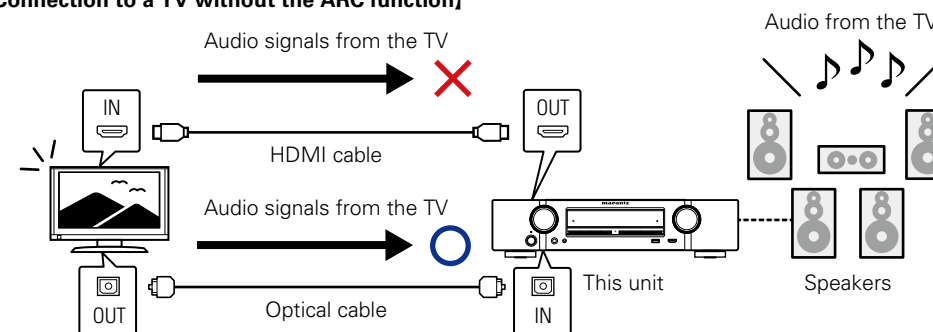

Connecting this unit to a TV via HDMI connections

Cables used for connections

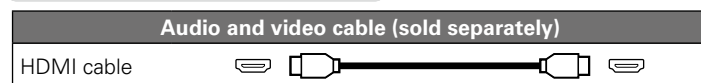

- This interface allows transfer of digital video signals and digital audio signals over a single HDMI cable.

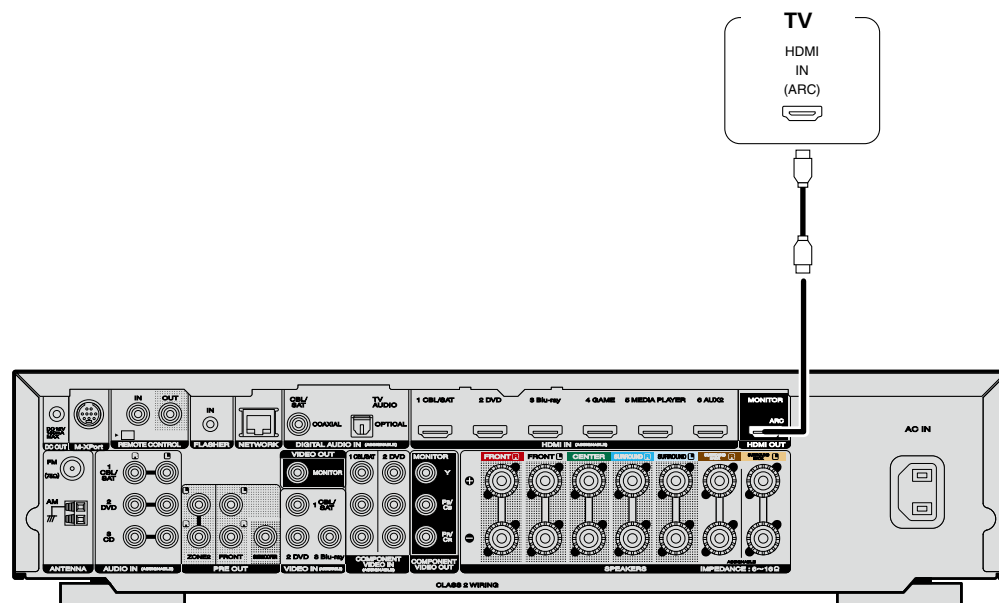

- Video signals are not output if the input video signals do not match the display's resolution. In this case, switch the Blu-ray Disc/DVD player's resolution to a resolution with which the display is compatible.
- When this unit and monitor are connected with an HDMI cable, if the display or monitor is not compatible with HDMI audio signal playback, only the video signals are sent to the display or monitor.

NOTE

- The audio signal from the HDMI output connector (sampling frequency, number of channels, etc.) may be limited by the HDMI audio specifications of the connected device regarding permissible inputs.
- **When connecting a TV that does not support the ARC function, an audio cable connection is required in addition to the HDMI cable. In this case, refer to "Connecting a TV" (page 13) for the connection method.**

For the ARC function, see "About ARC (Audio Return Channel) function" (page 8).

Connecting to a device equipped with a DVI-D connector

The DVI-D (Digital Visual Interface) method is also used for video transmission via digital signals. This is developed mainly for computers, and some displays such as projectors are equipped with this interface. To output HDMI video signals to a DVI-D video input compatible device, use an HDMI/DVI conversion cable or adapter.

The DVI-D connector can transmit high quality digital video signals, but copy guard and other issues may hinder normal operations for some device combinations.

NOTE

- No sound is output when connected to a device equipped with a DVI-D connector. Make audio connections as described in "Connecting a TV" (page 13).
- Signals cannot be output to DVI-D devices that do not support HDCP.
- Depending on the combination of devices, the video signals may not be output.

Settings required when using a TV that supports the ARC function

When using a TV that supports the ARC function, make the following settings.

- Set "HDMI Control" (page 116) to "On".

Connecting this unit to video devices via HDMI connections

Cables used for connections

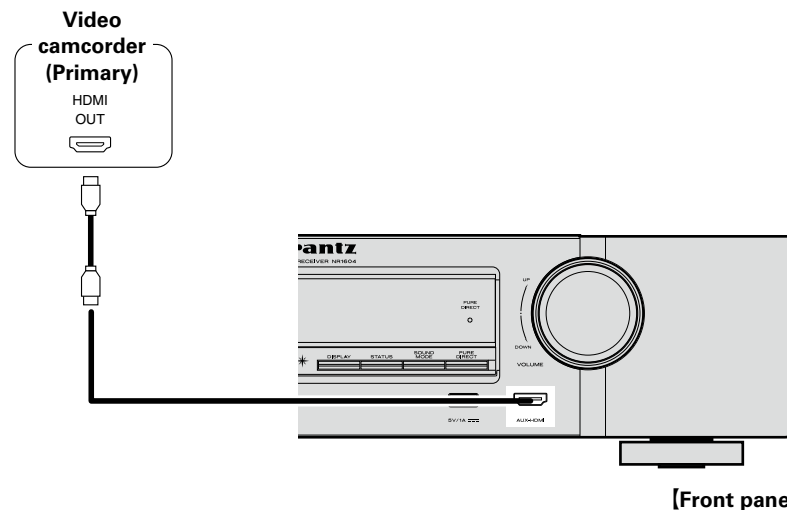
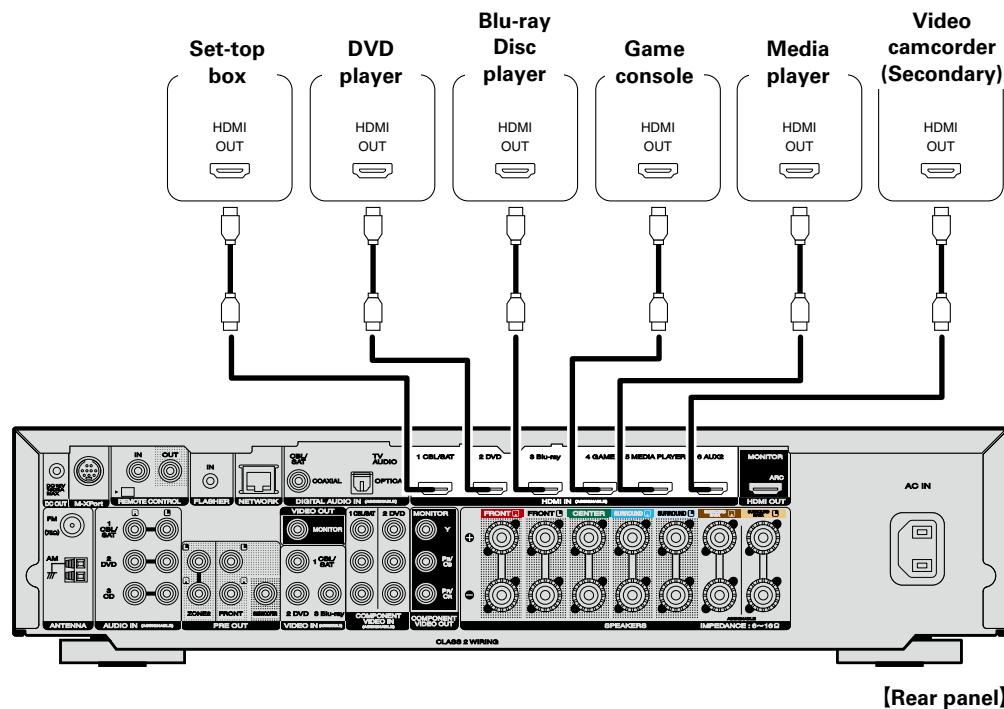
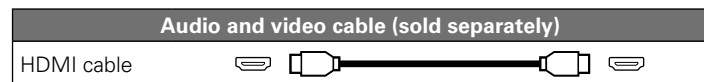

- When connecting a device that supports Deep Color or 4K, please use a “High Speed HDMI cable” or “High Speed HDMI cable with Ethernet”.
- Video signals are not output if the input video signals do not match the display’s resolution. In this case, switch the Blu-ray Disc/DVD player’s resolution to a resolution with which the display is compatible.

HDMI function

This unit supports the following HDMI functions:

□ About 3D function

This unit supports input and output of 3D (3 dimensional) video signals of HDMI.

To play back 3D video, you need a TV and player that provide support for the HDMI 3D function and a pair of 3D glasses.

NOTE

- When playing back 3D video, refer to the instructions provided in the manual of your playback device together with this manual.
- When playing back 3D video content, the menu screen or status display screen can be superimposed over the image. However, the menu screen or status display screen cannot be superimposed over certain 3D video content.
- If 3D video with no 3D information is input, the menu screen and status display on this unit are displayed over the playback video.
- If 2D video is converted to 3D video on the television, the menu screen and status display on this unit are not displayed correctly. To view the menu screen and status display on this unit correctly, turn the television setting that converts 2D video to 3D video off.

□ About 4K function

This unit supports input and output of 4K (3840 x 2160 pixels) video signals over HDMI.



When a device supporting 4K is connected, use a cable compatible with “High Speed HDMI cable” or “High Speed HDMI cable with Ethernet”.

□ HDMI pass through function (page 115)

Signals input to the HDMI input connector are output to the television or other device connected to the HDMI output connector, even if the power of this unit is in standby.

□ HDMI control function (page 95)

This function allows you to operate external devices from the unit and operate the unit from external devices.

NOTE

- The HDMI control function may not work depending on the device it is connected to and its settings.
- You cannot operate a TV or Blu-ray Disc player/DVD player that is not compatible with the HDMI control function.

□ About Content Type

This function was added with the HDMI standard. It automatically makes settings suitable for the video-output type (content information).

NOTE

To enable the Content Type, set “Video Mode” to “Auto” (page 116).

□ Deep Color (page 150)

When a device supporting Deep Color is connected (such as an HD camcorder), use a cable compatible with “High Speed HDMI cable” or “High Speed HDMI cable with Ethernet”.

□ Auto Lip Sync (page 115, 150)

□ “x.v.Color”, sYCC601 color, Adobe RGB color, Adobe YCC601 color (page 150, 151, 152)

□ High definition digital audio format

□ ARC (Audio Return Channel) (page 8)

Copyright protection system

In order to play back digital video and audio such as BD-Video or DVD-Video via HDMI connection, both this unit and TV or the player need to support the copyright protection system known as HDCP (High-bandwidth Digital Content Protection System). HDCP is copyright protection technology comprised of data encryption and authentication of the connected AV devices. This unit supports HDCP.

- If a device that does not support HDCP is connected, video and audio are not output correctly. Read the owner’s manual of your television or player for more information.

Settings related to HDMI connections

Set as necessary. For details, see the respective reference pages.

□ HDMI Setup (page 115)

Make settings for HDMI video/audio output.

- | | | |
|------------------|---------------------|-----------------------|
| • Auto Lip Sync | • HDMI Pass Through | • Pass Through Source |
| • HDMI Audio Out | • HDMI Control | • Power Off Control |

NOTE

To output audio signals that are input from the HDMI input connector to a TV connected via HDMI, set “HDMI Audio Out” (page 115) to “TV”.

















Audio signals input via the Analog/Coaxial/Optical input connectors cannot be output from the HDMI MONITOR output connector.

Connecting other devices







For highest quality video and surround playback, it is recommended to use an HDMI cable to connect this unit to TV and other video devices (see [page 7](#) "Connecting HDMI devices").

This section describes alternate connection methods when your device does not support HDMI connections.

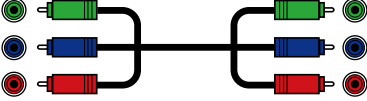
Connection methods for various devices

 TV	 page 13	 CBL/SAT	 page 14
 DVD	 page 15	 iPod/USB	 page 16
 CD	 page 17	 TUNER	 page 18
 M-XPoRT	 page 19	 NETWORK	 page 20

Cables used for connections

Video cable (sold separately)	
Component video cable	
Video cable	
Audio cable (sold separately)	
Coaxial digital cable	
Optical cable	
Audio cable	
Cable (sold separately)	
LAN cable	

Changing the source assigned to connectors

This unit can change the source that is assigned to the HDMI IN, DIGITAL AUDIO IN, COMPONENT VIDEO IN, VIDEO IN and AUDIO IN connectors.

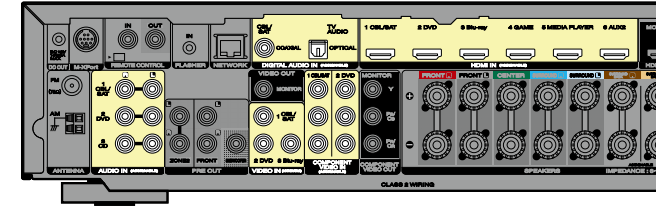

Let us take a digital audio connection for Blu-ray Disc players for an example. The rear panel digital audio input connectors do not have the input connector indication for Blu-ray disc players (Blu-ray). However, DIGITAL AUDIO IN connectors have the "ASSIGNABLE" indication, which means that you can change the source assigned to these connectors. You can assign Blu-ray disc players to these connectors to use them for Blu-ray disc players. Select "Blu-ray" when switching functions on this unit to play back the source connected to these connectors.

□ How to change the source assigned to connectors ([page 120](#))

Connecting a TV

- This section describes how to connect when your TV does not support ARC (Audio Return Channel). For instructions on HDMI connections, see “Connecting this unit to a TV via HDMI connections” ([page 9](#)).
- To listen to TV audio through this unit, use the optical digital connection.

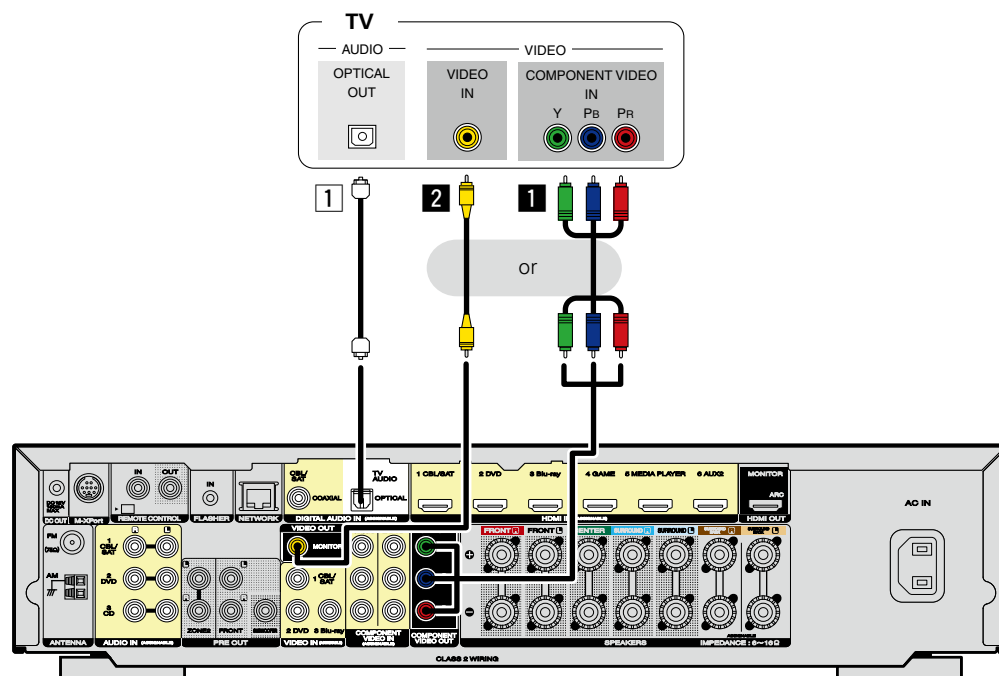

Audio connection

The following methods are available for connecting to this unit.

1 DIGITAL AUDIO OPTICAL connector

When a multichannel audio (digital bit stream audio) is input, this unit decodes the audio to play back surround sound.

Video connection

The following methods are available for connecting to this unit. **Use either of the methods to make a connection.**

The numbers prefixed with connectors indicate the recommendation order. The smaller the number is, the higher playback quality is achieved.

1 COMPONENT VIDEO OUT (MONITOR) connector

This makes an analog video connection. This connection method separates video signals into 3 signals for transmission based on color components, achieving the best quality video playback among analog video connections, with less signal degradation.

2 VIDEO OUT (MONITOR) connector

This makes an analog video connection.

The sections in the connection diagram are also available for connections. To connect devices to these connectors, you must set up input connectors. For details, see “Input Assign” ([page 120](#)).

NOTE

- The menu screen is only displayed on TV connected to this unit via HDMI. If your TV is connected to this unit via other video output connectors, perform menu operations while seeing the display on this unit.**
- If you do not connect this unit to your TV via HDMI, do not make HDMI connections for video inputs from other video devices, either. For details see “Converting input video signals for HD output (Video conversion function)” ([page 6](#)).
- When content on iPod, USB memory devices, or the network is being played back with your TV connected to the COMPONENT VIDEO OUT or VIDEO OUT connector, screens output from this unit such as the playback screen cannot be displayed.

Connecting a set-top box (Satellite tuner/cable TV)

This section describes how to connect when your satellite tuner or cable TV does not support HDMI connections.

For instructions on HDMI connections, see “Connecting HDMI devices” ([page 7](#)).

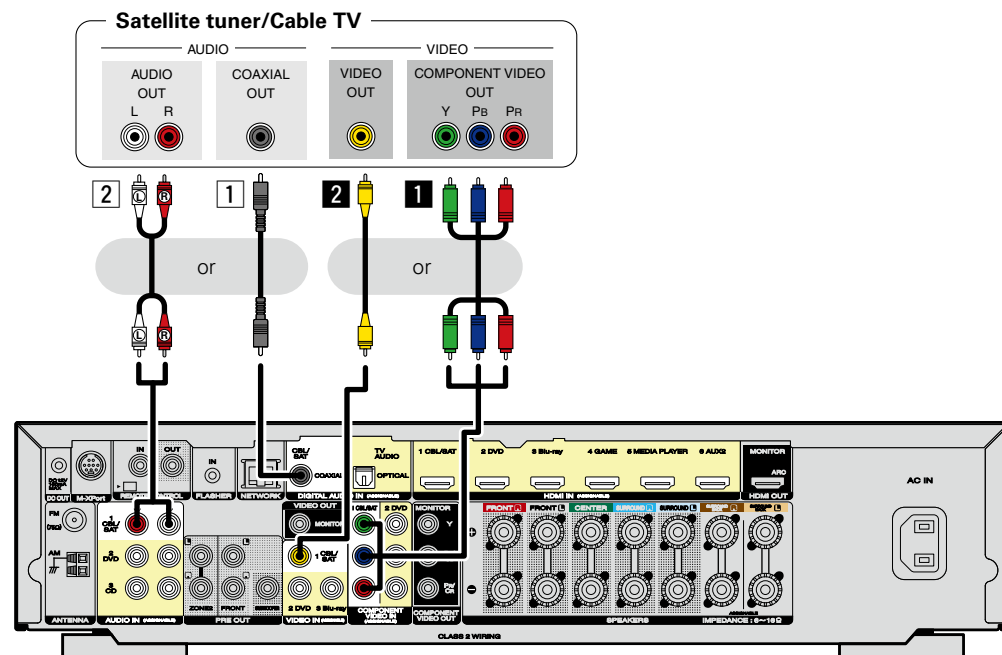

Audio connection

The following methods are available for connecting to this unit. **Use either of the methods to make a connection.**

The numbers prefixed with connectors indicate the recommendation order. The smaller the number is, the higher playback quality is achieved.

1 DIGITAL AUDIO COAXIAL connector

When a multichannel audio (digital bit stream audio) is input, this unit decodes the audio to play back surround sound.

2 AUDIO IN (CBL/SAT) connector

This makes an analog audio connection.

Video connection

The following methods are available for connecting to this unit. **Use either of the methods to make a connection.**

The numbers prefixed with connectors indicate the recommendation order. The smaller the number is, the higher playback quality is achieved.

1 COMPONENT VIDEO IN (CBL/SAT) connector

This makes an analog video connection. This connection method separates video signals into 3 signals for transmission based on color components, achieving the best quality video playback among analog video connections, with less signal degradation.

2 VIDEO IN (CBL/SAT) connector

This makes an analog video connection.

The sections in the connection diagram are also available for connections. To connect devices to these connectors, you must set up input connectors. For details, see “Input Assign” ([page 120](#)).

Connecting a DVD player

This section describes how to connect a DVD player that does not support HDMI connections. For instructions on HDMI connections, see “Connecting HDMI devices” ([page 7](#)).

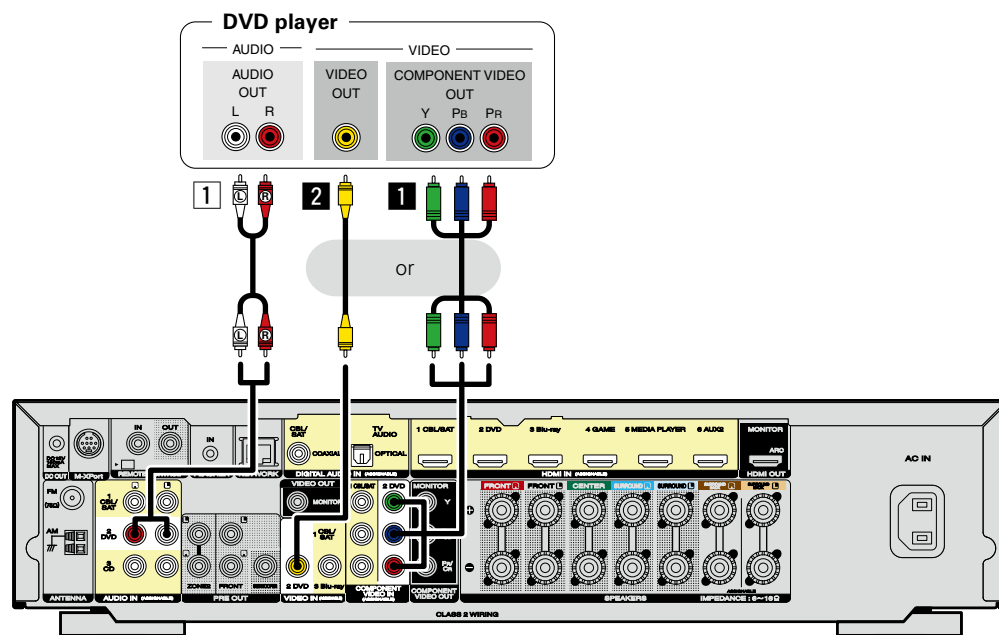

Audio connection

The following methods are available for connecting to this unit.

1 AUDIO IN (DVD) connector

This makes an analog audio connection.

Video connection

The following methods are available for connecting to this unit. **Use either of the methods to make a connection.**

The numbers prefixed with connectors indicate the recommendation order. The smaller the number is, the higher playback quality is achieved.

1 COMPONENT VIDEO IN (DVD) connector

This makes an analog video connection. This connection method separates video signals into 3 signals for transmission based on color components, achieving the best quality video playback among analog video connections, with less signal degradation.

2 VIDEO IN (DVD) connector

This makes an analog video connection.

The sections in the connection diagram are also available for connections. To connect devices to these connectors, you must set up input connectors. For details, see “Input Assign” ([page 120](#)).

Connecting an iPod or USB memory device to the USB port

- You can enjoy music stored on an iPod or USB memory device.
- For operating instructions see “Playing an iPod” (page 31) or “Playing a USB memory device” (page 34).

Cables used for connections

To connect an iPod to this unit, use the USB adapter cable that was supplied with the iPod.

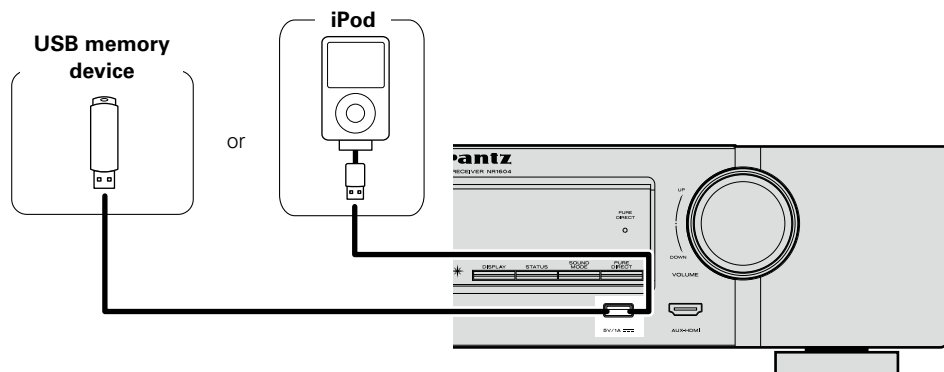

Marantz does not guarantee that all USB memory devices will operate or receive power. When using a portable USB hard disk drive (HDD) which came with an AC adapter, use that device's supplied AC adapter.

NOTE

- USB memory devices will not work via a USB hub.
- It is not possible to use this unit by connecting the unit's USB port to a PC via a USB cable.
- Do not use an extension cable when connecting a USB memory device. This may cause radio interference with other devices.
- When connecting an iPhone to this unit, keep the iPhone at least 20 cm (8 inches) away from this unit. If the iPhone is positioned close to this unit and a telephone call is received, noise may be output from this unit.
- If the iPod is connected using an iPod cable (commercially available) that is longer than 2 meters (6 feet) sound may not be played correctly. In this case, use a genuine iPod cable, or a cable that is shorter than 1 meter (3 feet).

Supported iPod models

• iPod classic



iPod classic
80GB



iPod classic
160GB (2007)



iPod classic
160GB (2009)

• iPod nano



iPod nano
3rd generation
(video)
4GB 8GB



iPod nano
4th generation (video)
8GB 16GB



iPod nano
5th generation (video camera)
8GB 16GB



iPod nano
6th generation
8GB 16GB



iPod nano
7th generation
16GB

• iPod touch



iPod touch
1st generation
8GB 16GB 32GB



iPod touch
2nd generation
8GB 16GB 32GB



iPod touch
3rd generation
32GB 64GB



iPod touch
4th generation
8GB 32GB 64GB



iPod touch
5th generation
32GB 64GB

• iPhone



iPhone
4GB 8GB 16GB



iPhone 3G
8GB 16GB



iPhone 3GS
8GB 16GB 32GB



iPhone 4
8GB 16GB 32GB



iPhone 4S
16GB 32GB 64GB



iPhone 5
16GB 32GB 64GB

Connecting a CD player

You can enjoy CD sound with the player connected by digital or analog cables.

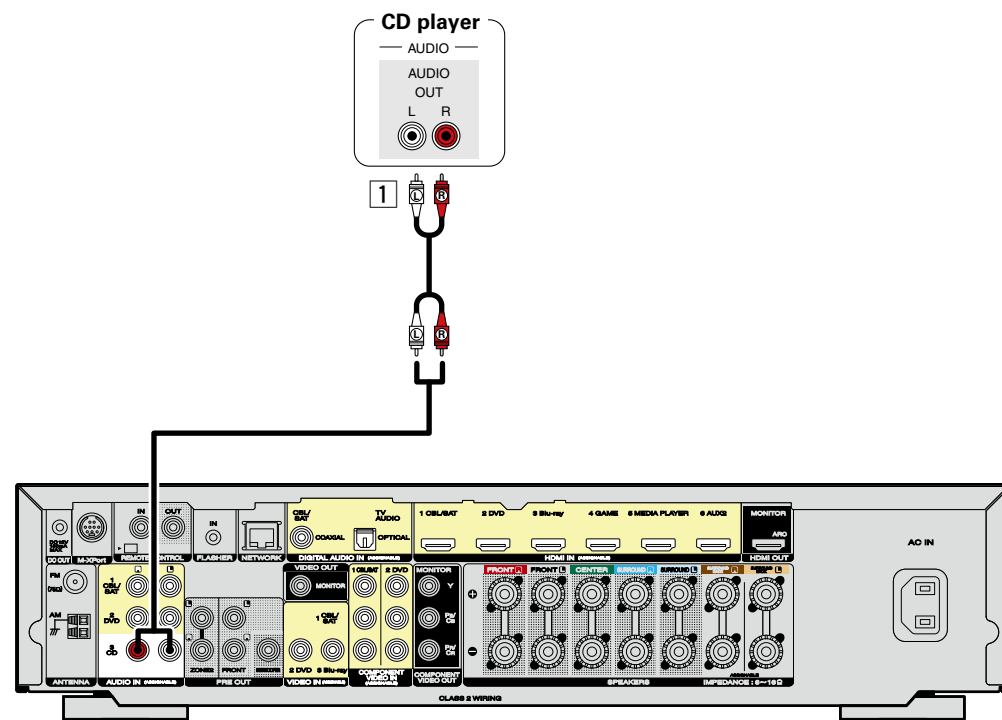

Audio connection

The following methods are available for connecting to this unit.

1 AUDIO IN (CD) connector

This makes an analog audio connection.

The sections in the connection diagram are also available for connections. To connect devices to these connectors, you must set up input connectors. For details, see "Input Assign" ([page 120](#)).

Connecting an FM/AM antenna

- Connect the FM antenna supplied with the unit to enjoy listening to radio broadcasts.
- After connecting the antenna and receiving a broadcast signal (see [page 37](#) "Listening to FM/AM broadcasts"), fix the antenna with tape in a position where the noise level becomes minimal.

AM loop antenna assembly

1 Put the stand section through the bottom of the loop antenna from the rear and bend it forward.

2 Insert the projecting part into the square hole in the stand.

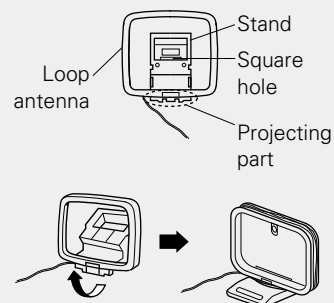

Using the AM loop antenna

Suspending on a wall

Suspend directly on a wall without assembling.

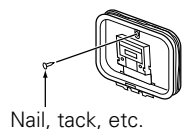

Nail, tack, etc.

Standing alone

Use the procedure shown above to assemble.

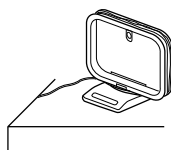

NOTE

- Do not connect two FM antennas simultaneously.
- Even if an external AM antenna is used, do not disconnect the AM loop antenna.
- Make sure the AM loop antenna lead terminals do not touch metal parts of the panel.
- If the signal has noise interference, connect the ground terminal (GND) to reduce noise.
- If you are unable to receive a good broadcast signal, we recommend installing an outdoor antenna. For details, inquire at the retail store where you purchased the unit.

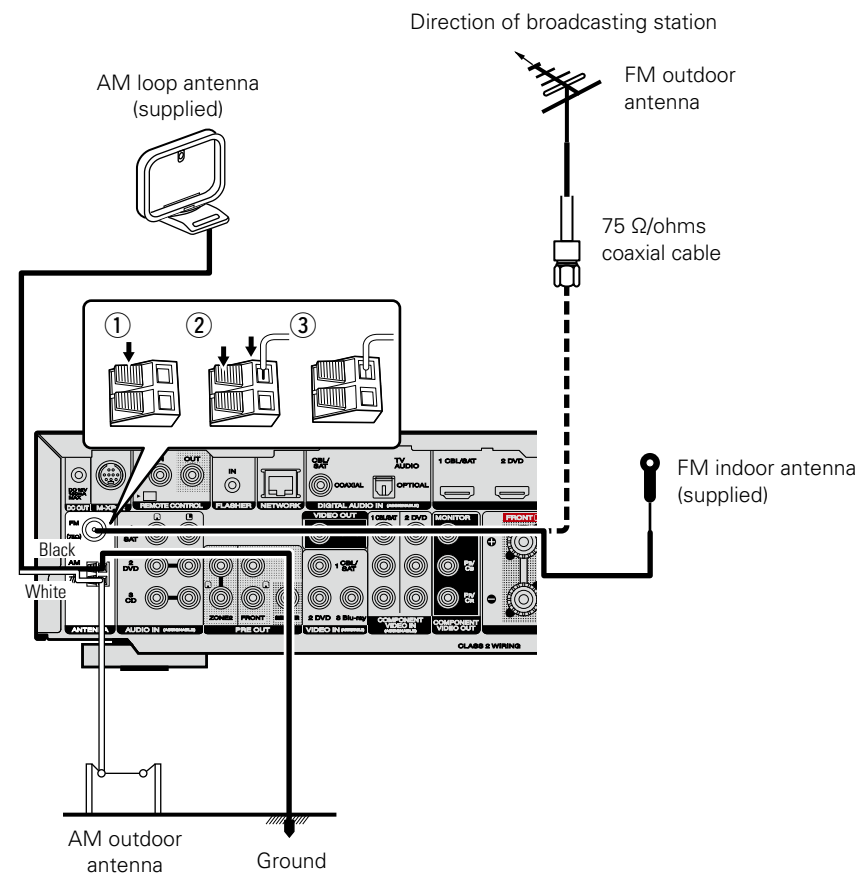

Connecting a wireless receiver (RX101)

- You can connect a wireless receiver (RX101, sold separately) to play back music on your Bluetooth device with this unit.
- To do this, switch the input source to "M-XPort" ([page 29](#) "Selecting the input source").
- This unit supports the A2DP standard of the Bluetooth profile.
- See also the manuals for your wireless receiver and Bluetooth device.



- When connecting your Bluetooth device to the wireless receiver for the first time, pairing is necessary. Once pairing is completed, the communication between your Bluetooth device and the wireless receiver can be established just by connecting them. Pairing is necessary for each Bluetooth device.
- You can also use the wireless receiver as an IR receiver. In this case, disable the remote control signal receiving function ([page 100](#) "Remote lock function").

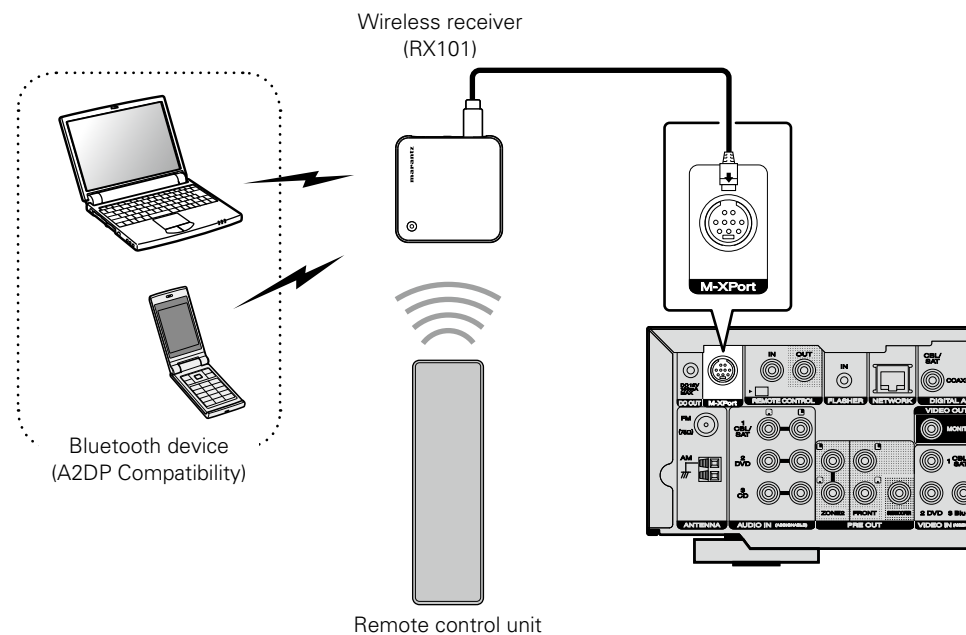

Connecting to a home network (LAN)

You can connect this unit to your home network (LAN) to perform various types of playbacks and operations as follows. Make network connections for this unit by carefully reading information on this page.

- Playback of network audio such as Internet Radio and from your media server(s)
- Playback of music content from online streaming services
- Using the Apple AirPlay function
- Operation on this unit via the network

In addition, if updated firmware becomes available for this unit, the updated information is delivered from us to this unit over the internet via your home network. You can then download and install the latest firmware.

For more information, on the menu, select "Update" ([page 135](#)).

Network settings are necessary. See "Network" on the menu ([page 127](#)) for more information on network setting.

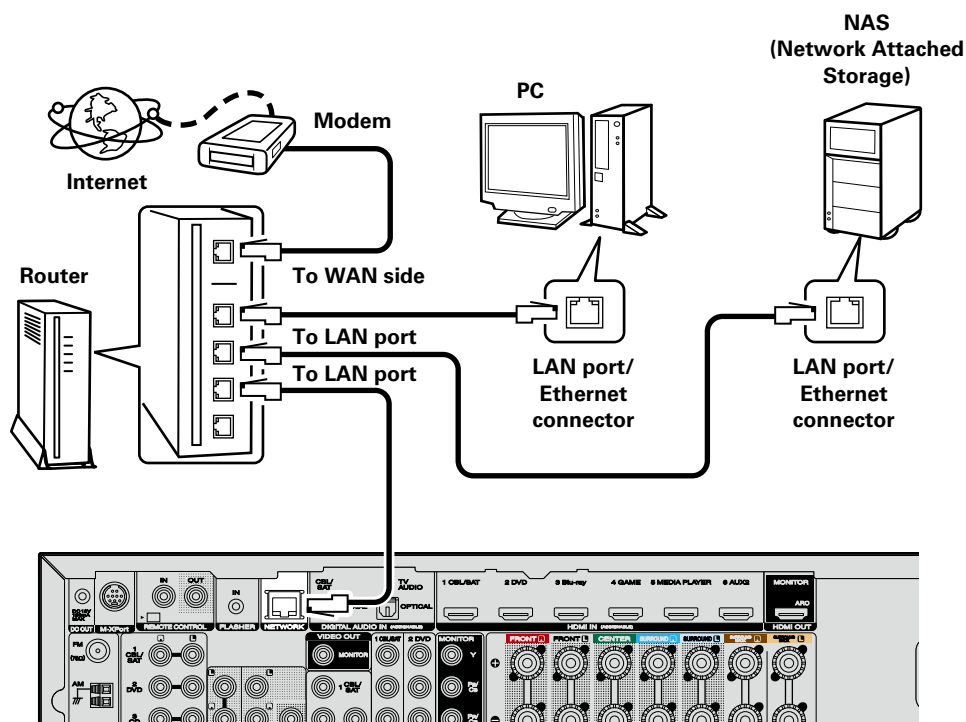

For connections to the Internet, contact an ISP (Internet Service Provider) or a computer shop.

Required system

Broadband internet connection

Modem

Device that connects to your broadband internet provider, and is very often supplied with the service. A type that is integrated with a router is also often available.

Router

When using this unit, we recommend you use a router equipped with the following functions:

- Built-in DHCP server
This function automatically assigns IP addresses on the LAN.
- Built-in 100BASE-TX switch
When connecting multiple devices, we recommend a switching hub with a speed of 100 Mbps or greater.

LAN cable (CAT-5 or greater recommended)

- Use only a shielded STP or ScTP LAN cable which is easily available at electronics stores.
- The normal shielded-type LAN cable is recommended. If a flat-type cable or unshielded-type cable is used, other devices could be affected by noise.



- If you have an Internet provider contract for a line on which network settings are made manually, make the settings at "Network" ([page 127](#)).
- With this unit, it is possible to use the DHCP and Auto IP functions to make the network settings automatically.
- When using this unit with the broadband router's DHCP function enabled, this unit automatically performs the IP address setting and other settings.
When using this unit connected to a network with no DHCP function, make the settings for the IP address, etc., at "Network" ([page 127](#)).
- When setting manually, check the settings with the network administrator or internet service provider.

NOTE

- A contract with an internet service provider (ISP) is usually required to connect to the Internet. No additional contract is needed if you already have a broadband connection to the Internet.
- The types of routers that can be used depend on the ISP. Contact your ISP or a computer shop for details.
- Marantz assumes no responsibility whatsoever for any communication errors or troubles resulting from the customer's network environment or connected devices.
- This unit is not compatible with PPPoE. A PPPoE-compatible router is required if you have a contract for a type of line set by PPPoE.
- Do not connect an NETWORK connector directly to the LAN port/ Ethernet connector on your computer.
- To listen to audio streaming, use a router that supports audio streaming.

Connecting the power cord

After completing all the connections, insert the power plug into the power outlet.

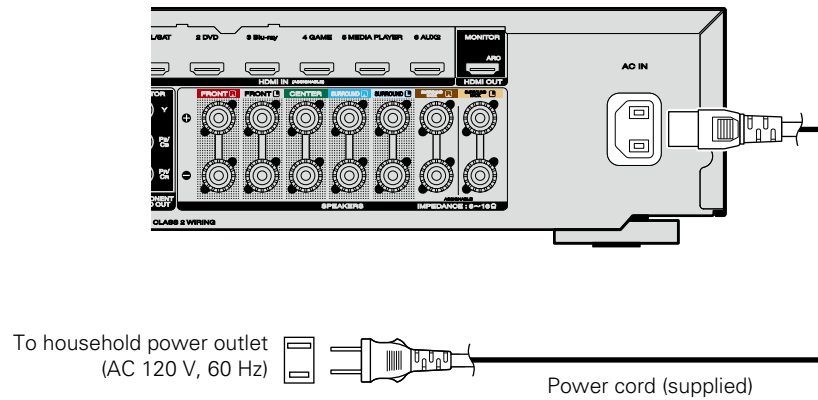

NOTE

- Do not plug in the power cord until all connections have been completed. However, when the "Setup Assistant" is running, follow the instructions in the "Setup Assistant" (page 7) screen for making connections. (During "Setup Assistant" operation, the input/output connectors do not conduct current.)
- Do not bundle power cords together with connection cables. Doing so can result in humming or noise.

Setup

Here, we explain “Audyssey® Setup”, which allows you to automatically make the optimal settings for your speakers, and “Network”, which allows you to connect this unit to a home network (LAN). This unit lets you play via your home network (LAN) music files stored on a computer and music content such as that from Internet Radio.

❑ **Speaker connection** (🔗 page 81)

❑ **Set up speakers (Audyssey® Setup)** (🔗 page 22)

❑ **Making the network settings (Network)**
(🔗 page 28)

Playback (Basic operation) (🔗 page 29)

Selecting a listening mode (Sound Mode)
(🔗 page 72)

Playback (Advanced operation) (🔗 page 95)



Set up speakers (Audyssey® Setup)



The acoustic characteristics of the connected speakers and listening room are measured and the optimum settings are made automatically. This is called “Audyssey® Setup”.

To perform measurement, place the Setup and measurement microphone in multiple locations all around the listening area. For best results, we recommend you measure in six positions, as shown in the illustration (up to six positions).

- When performing Audyssey® Setup, Audyssey MultEQ®/Audyssey Dynamic EQ®/Audyssey Dynamic Volume® functions become active (🔗 page 112, 113).
- To set up the speakers manually, use “Speakers” (🔗 page 123) on the menu.

NOTE

- Make the room as quiet as possible. Background noise can disrupt the room measurements. Close windows and turn off the power on electronic devices (TVs, radios, air conditioners, fluorescent lights, etc.). The measurements could be affected by the sounds emitted by such devices.
- During the measurement process, place cell phones outside the listening room. Cell phone signals could disrupt the measurements.
- Do not unplug the Setup and measurement microphone from the main unit until Audyssey® Setup is completed.
- Do not stand between the speakers and Setup and measurement microphone or allow obstacles in the path while the measurements are being made. This will cause inaccurate readings.
- During the measurement process, audible test tones will come from the speakers and subwoofer(s), but this is part of normal operation. If there is background noise in the room, these test signals will increase in volume.
- Operating **VOLUME ▲▼** on the remote control unit or **VOLUME** on the main unit during the measurements will cancel the measurements.
- Measurement cannot be performed when headphones are connected. Unplug the headphones before performing Audyssey® Setup.

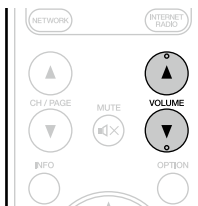

About Setup and measurement microphone placement

- Measurements are performed by placing the Setup and measurement microphone successively at multiple positions throughout the entire listening area, as shown in [Example ①]. For best results, we recommend you measure in six positions, as shown in the illustration (up to six positions).
- Even if the listening environment is small as shown in [Example ②], measuring at multiple points throughout the listening environment results in more effective correction.

[Example ①]

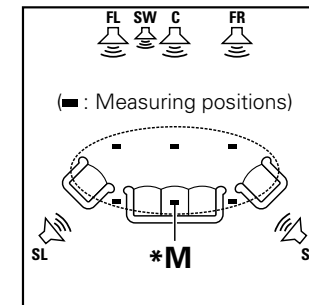

[Example ②]

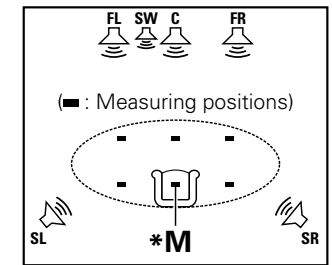

FL Front speaker (L)
FR Front speaker (R)
C Center speaker

SW Subwoofer
SL Surround speaker (L)
SR Surround speaker (R)

About the main listening position (*M)

The main listening position is the position where listeners would normally sit or where one would normally sit alone within the listening environment. Before starting Audyssey® Setup, place the Setup and measurement microphone in the main listening position. Audyssey MultEQ® uses the measurements from this position to calculate speaker distance, level, polarity, and the optimum crossover value for the subwoofer.

1 Prepare the included Setup and measurement microphone

Mount the Setup and measurement microphone on a tripod or stand and place it in the main listening position.

When placing the Setup and measurement microphone, adjust the height of the sound receptor to the level of the listener's ear.

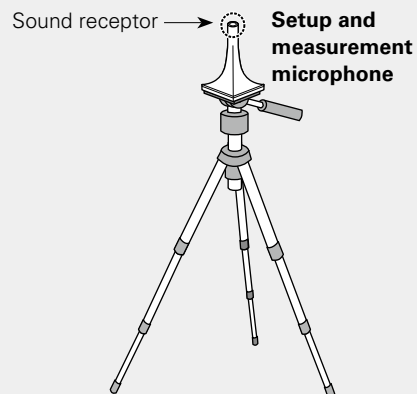

If you do not have a tripod or stand, set up the microphone on, for example, a seat without a back.

NOTE

- Do not hold the Setup and measurement microphone in your hand during measurements.
- Avoid placing the Setup and measurement microphone close to a seat back or wall as sound reflections may give inaccurate results.

2 Set up the subwoofer

If using a subwoofer capable of the following adjustments, set up the subwoofer as shown below.

For details, see your subwoofer's manual.

- When using a subwoofer with a direct mode**
Set the direct mode to "On" and disable the volume adjustment and crossover frequency setting.
- When using a subwoofer without a direct mode**
Make the following settings:
 - **Volume** : "12 o'clock position"
 - **Crossover frequency** : "Maximum/Highest Frequency"
 - **Low pass filter** : "Off"
 - **Standby mode** : "Off"

3 Set up the zone mode

Press **MAIN** to switch the zone mode.
MAIN lights.

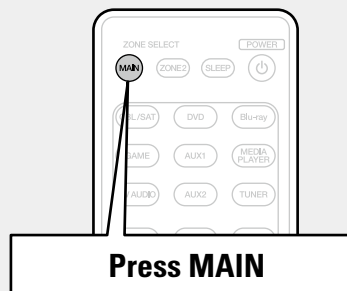

Preparation

4 Connect the Setup and measurement microphone to the SETUP MIC jack of this unit.

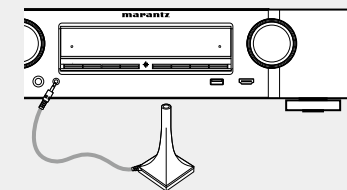

When the Setup and measurement microphone is connected, the following screen is displayed.



- Here, we explain setup using the example of 7.1-channel speaker playback.

For settings other than 7.1-channel speaker playback, select "Amp Assign" and perform step 3 to 6 of "Set up "Amp Assign"" ([page 91](#)).

If unused channels are set with "Channel Select", measuring time can be shortened. For setting, perform steps 7 to 12 of "Set up "Channel Select"" ([page 92](#)).

Preparation (Continued)

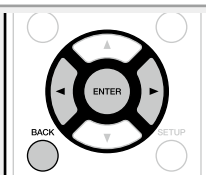
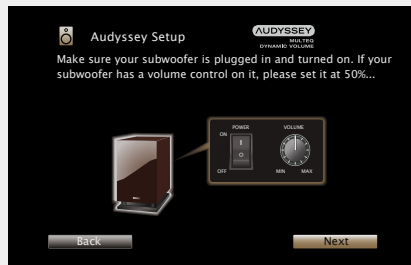
5 Select “Start” and then press **ENTER**.**6** Select “Next” and then press **ENTER**.
The subwoofer volume setting screen is displayed.

Detection & Measurement (Main)

This step automatically checks the speaker configuration and speaker size, and calculates the channel level, distance, and crossover frequency.

It also corrects distortion in the listening area.

7 Select “Begin Test” and then press **ENTER**.

When measuring begins, a test tone is output from each speaker.

- Measurement requires several minutes.

8 The detected speakers are displayed.

- The illustration below shows an example of when the front speakers, center speaker, subwoofer, surround and surround back speakers have been detected.

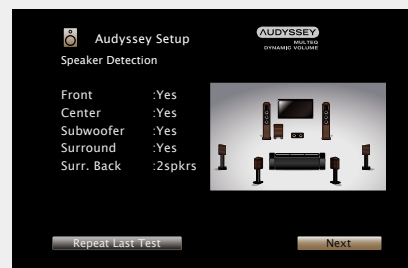
**NOTE**

If a connected speaker is not displayed, the speaker may not be connected correctly. Check the speaker connection.

9 Select “Next” and then press **ENTER**.**NOTE**

If “Caution!” is displayed on TV screen:

Go to “Error messages” (page 27). Check any related items, and perform the necessary procedures.

If the problem is resolved, return and restart “Audyssey® Setup”.

Going back to the previous screen

Select “Back” and then press **ENTER**.

When measuring has stopped

- ① Press **BACK** to display the popup screen.
- ② Press **◀** to select “Yes”, and then press **ENTER**.

Setting up the speakers again

Repeat the operation from step 4.

Measurement (2nd – 6th)

- In this step, you will perform measurements at multiple positions (one to five additional positions) other than the main listening position.
- Just one listening position can be measured if you so choose, but measuring multiple positions increases the accuracy of the correction of acoustic distortion within the listening area.

10 Move the Setup and measurement microphone to position 2, select “Continue”, and then press ENTER.

The measurement of the second position starts. Measurements can be made in up to six positions.

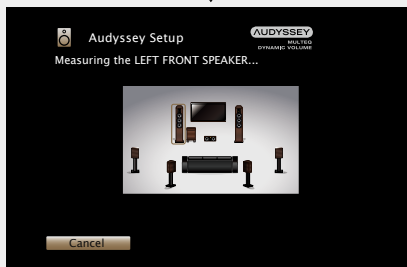
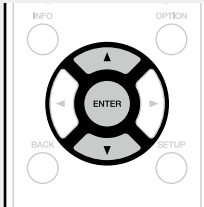

- To skip measuring the second and subsequent listening position, use ∇ to select “Calculation” and press **ENTER** to proceed to step 13.
- To measure the second position again, use ∇ to select “Repeat Last Test” and press **ENTER**.

Calculation

11 Repeat step 10, measuring positions 3 to 6.

When measurement of position 6 is completed, a “Measurements finished.” message is displayed.

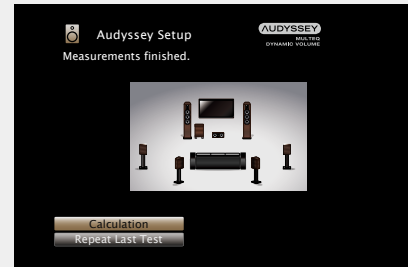

12 Select “Calculation” and then press ENTER.

Measuring results are analyzed, and the frequency response of each speaker in the listening room is determined.

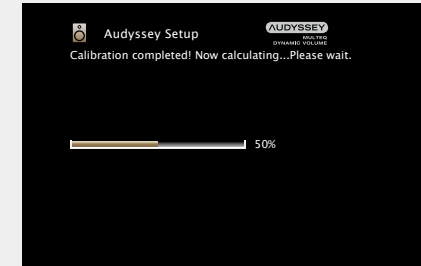

- Analysis takes several minutes to complete. The more speakers and measurement positions that there are, the more time it takes to perform the analysis.

Check

- 13** Use Δ / ∇ to select the item you want to check, and then press **ENTER**.

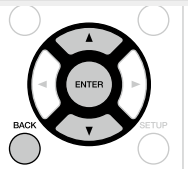

- Subwoofers may measure a greater reported distance than the actual distance due to added electrical delay common in subwoofers.
- If you want to check another item, press **BACK**.

NOTE

- If the result differs from the actual connection status, or if "Caution!" is displayed, see "Error messages" ([page 27](#)). Then carry out Audyssey® Setup again.
- If you change speaker positions or orientation, perform Audyssey® Setup again to find the optimal equalizer settings.

Store

- 14** Select "Store" and then press **ENTER**.
Save the measurement results.

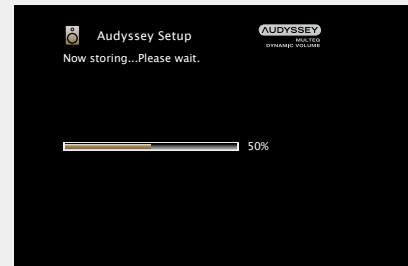
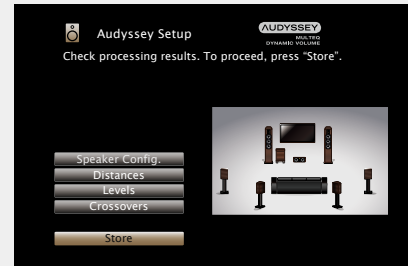

- Saving the results requires about 20 seconds.
- During saving of measurements results, "Now storing...Please wait." is displayed. When saving is completed, "Storing complete. Audyssey® Setup is now finished. Please unplug microphone." is displayed.

NOTE

During saving of measurement results, be sure not to turn off the power.

Finish

- 15** Unplug the Setup and measurement microphone from the unit's SETUP MIC jack.

- 16** Set Audyssey Dynamic Volume®.

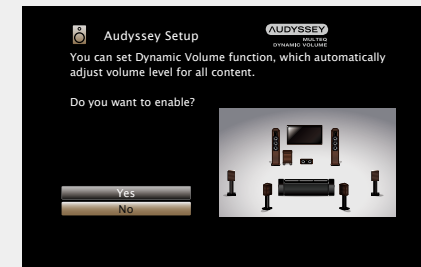

- This feature adjusts the output volume to the optimal level while constantly monitoring the level of the audio input to the unit. Optimal volume control is performed automatically without any loss in the dynamism and clarity of the sound when, for example, the volume suddenly increases for commercials shown during television programs.

 When turning Dynamic Volume on

- Press Δ to select "Yes", and then press **ENTER**.

The unit automatically enters "Medium" ([page 113](#)) mode.

 When turning Dynamic Volume off

- Press ∇ to select "No", and then press **ENTER**.



NOTE

After performing Audyssey® Setup, do not change the speaker connections or subwoofer volume. In event of a change, perform Audyssey® Setup again.

Error messages

NOTE

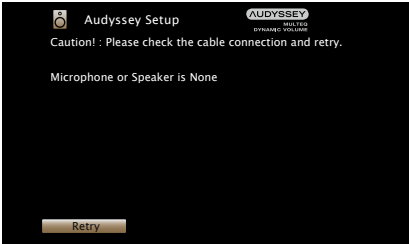
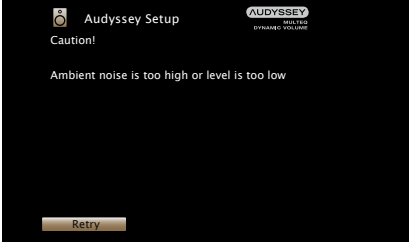
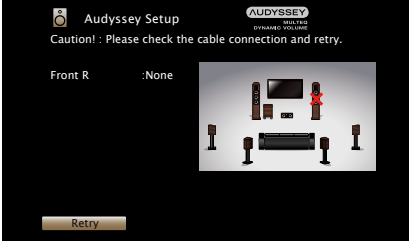
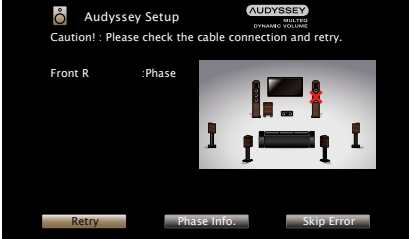
- An error message is displayed if Audyssey® Setup could not be completed due to speaker placement, the measurement environment, etc. If an error message is displayed, check the relevant items and perform the necessary measures. Then perform Audyssey® Setup again.
- If the result still differs from the actual connection status after re-measurement or the error message still appears, it is possible that the speakers are not connected properly. Turn this unit off, check the speaker connections and repeat the measurement process from the beginning.
- Be sure to turn off the power before checking speaker connections.

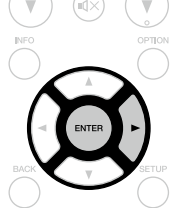
Examples	Error details	Measures
 <p>Audyssey Setup Caution! : Please check the cable connection and retry. Microphone or Speaker is None Retry</p>	<ul style="list-style-type: none"> • The connected Setup and measurement microphone is broken, or a device other than the supplied Setup and measurement microphone is connected. • Not all speakers could be detected. 	<ul style="list-style-type: none"> • Connect the included Setup and measurement microphone to the SETUP MIC jack of this unit. • Check the speaker connections.
 <p>Audyssey Setup Caution! Ambient noise is too high or level is too low Retry</p>	<ul style="list-style-type: none"> • There is too much noise in the room for accurate measurements to be made. • Speaker or subwoofer sound is too low for accurate measurements to be made. 	<ul style="list-style-type: none"> • Either turn off any device generating noise or move it away. • Perform again when the surroundings are quieter. • Check the speaker installation and the direction in which the speakers are facing. • Adjust the subwoofer's volume.
 <p>Audyssey Setup Caution! : Please check the cable connection and retry. Front R :None Retry</p>	<ul style="list-style-type: none"> • The displayed speaker could not be detected. (The screen on the left indicates that the front right speaker cannot be detected.) 	<ul style="list-style-type: none"> • Check the connections of the displayed speaker.
 <p>Audyssey Setup Caution! : Please check the cable connection and retry. Front R :Phase Retry Phase Info. Skip Error</p>	<ul style="list-style-type: none"> • The displayed speaker is connected with the polarity reversed. (The screen on the left indicates that the polarity phases of the front right speakers are reversed.) 	<ul style="list-style-type: none"> • Check the polarity of the displayed speaker. • For some speakers, this error message may be displayed even if the speaker is properly connected. If you are sure the connection is correct, use  to select "Skip Error", then press ENTER. 

Check Results

This function enables you to check the measurement results and equalizer characteristics after Audyssey® Setup.

- 1** Press **SETUP** to display the menu on the TV screen.
- 2** Use Δ to select “Speakers” – “Audyssey® Setup” and then press **ENTER** or \triangleright .
- 3** Use ∇ to select “Check Results” and then press **ENTER**.

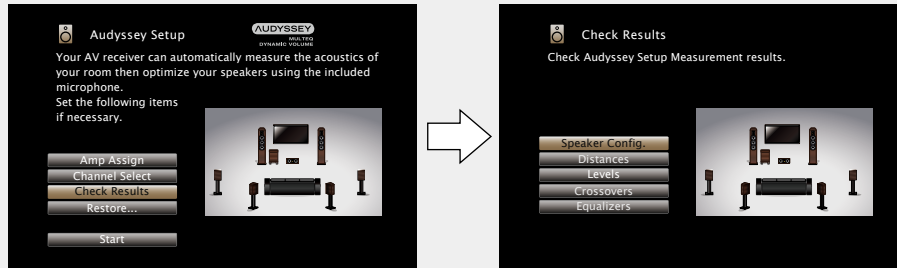

- 4** Use Δ / ∇ to select the item you want to check, then press **ENTER**.
Measurement results for each speaker are displayed.

Speaker Config.	Check the speaker configuration.
Distances	Check the speaker distance.
Levels	Check the speaker channel level.
Crossovers	Check the speaker crossover frequency.
Equalizers	Check the equalizer.

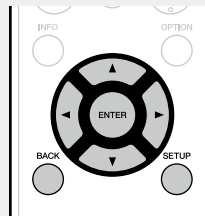

- If “Equalizers” is selected, press Δ / ∇ to select equalizing curve (“Audyssey” or “Audyssey Flat”) to be checked.
Use Δ / ∇ to switch the display between the different speakers.

- 5** Press \triangleleft or **BACK**.
The confirmation screen reappears. Repeat step 2.

Retrieving Audyssey® Setup settings

If you set “Restore...” to “Restore”, you can return to Audyssey® Setup measurement result (value calculated at the start by MultEQ®) even when you have changed each setting manually.



Making the network settings (Network)



This unit can be connected to a home network (LAN) to listen to Internet Radio or play back music files and still image (JPEG) files stored on a computer.

- 1** Connect the LAN cable (👉 [page 20](#) “Connecting to a home network (LAN)”).
- 2** Turn on this unit (👉 [page 29](#)).
This unit performs automatic network setup due to the DHCP function.
When connecting to a network that has no DHCP function, perform the setting in “Settings” (👉 [page 129](#)).

Playback (Basic operation)

Setup (page 22)

- ❑ Turning the power on (page 29)
- ❑ Selecting the input source (page 29)
- ❑ Adjusting the master volume (page 30)
- ❑ Turning off the sound temporarily (page 30)

- ❑ Playing a Blu-ray Disc player/DVD player (page 30)

- ❑ Playing a CD player (page 30)
- ❑ Playing an iPod (page 31)
- ❑ Playing a USB memory device (page 34)
- ❑ Listening to FM/AM broadcasts (page 37)

- ❑ Listening to Internet Radio (page 46)
- ❑ Playing back files stored on a PC and NAS (page 49)
- ❑ Using online services (page 53)
- ❑ Convenient functions (page 64)
- ❑ AirPlay function (page 70)

Selecting a listening mode (Sound Mode) (page 72)

Playback (Advanced operation) (page 95)

Important information

Before starting playback, make the connections between the different devices and the settings on the unit.

NOTE

Also refer to the operating instructions of the connected devices when playing them.

Turning the power on

Press **POWER** to turn on power to the unit.



You can also switch the power to standby by pressing on the main unit.

When power is switched to standby

Press **POWER**.

[Power indicator status in standby mode]

Normal standby : Red

- When "HDMI Pass Through" or "HDMI Control" (page 116) is set to "On" : Orange
- When "IP Control" (page 128) is set to "Always On" : Orange

Selecting the input source

Press the input source select button (CBL/SAT, DVD, Blu-ray, GAME, AUX1, MEDIA PLAYER, TV AUDIO, AUX2, TUNER, iPod/USB, M-XPport, CD, NETWORK or INTERNET RADIO) to be played back.

The desired input source can be selected directly.

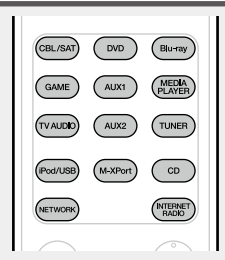

You can also use the following operation to select an input source.

Select the input source using the main unit

Turn **INPUT SELECTOR**.

- Turning **INPUT SELECTOR** switches the input source, as shown below.

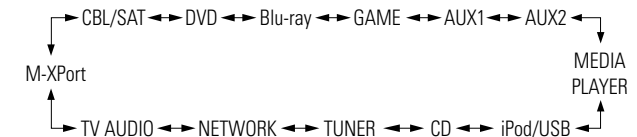

Adjusting the master volume

Use **VOLUME ▲▼** to adjust the volume.

- The volume display method varies depending on the “Scale” setting (page 112).



When the “Scale” setting (page 112) is “0 – 98”

[Adjustable range] 0.0 0.5 – 98.0

When the “Scale” setting (page 112) is “–79.5dB – 18.0dB”

[Adjustable range] ---- –79.5dB – 18.0dB

- The variable range differs according to the input signal and channel level setting.



You can also adjust the master volume by turning **VOLUME** on the main unit.

Turning off the sound temporarily

Press **MUTE** .

- “MUTE” indicator on the display flashes.
-  appears on the TV screen.



- The sound is reduced to the level set at “Mute Level” (page 112).
- To cancel, press **MUTE**  again. Muting can also be cancelled by adjusting the master volume.

Playing a Blu-ray Disc player/DVD player

The following describes the procedure for playing Blu-ray Disc player/DVD player.

1 Prepare for playback.

- ① Turn on the power of the TV, subwoofer and player.
- ② Change the TV input to the input of this unit.
- ③ Load the disc in the player.

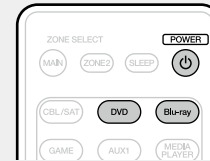

2 Press **POWER** to turn on power to the unit.

3 Press **DVD** or **Blu-ray** to switch an input source for a player used for playback.

4 Play the Blu-ray Disc player or DVD player.

- Make the necessary settings on the player (language setting, subtitles setting, etc.) beforehand.

Playing a CD player

The following describes the procedure for playing CD player.

1 Prepare for playback.

- ① Turn on the power of the subwoofer and player.
- ② Load the disc in the player.

2 Press **POWER** to turn on power to the unit.

3 Press **CD** to switch the input source to “CD”.

4 Play the CD player.

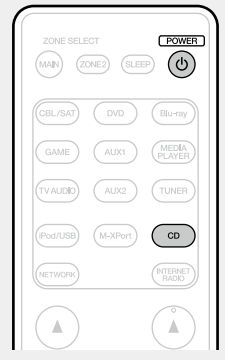

Playing an iPod

You can use the USB cable provided with the iPod to connect the iPod with the unit's USB port and enjoy music stored on the iPod.

For information on the iPod models that can be played back with this unit, see "Connecting an iPod or USB memory device to the USB port" ([page 16](#)).

Listening to music on an iPod

The iPod display modes include "From iPod" and "On-Screen". By default, "From iPod", where you directly operate the iPod itself while looking at the iPod screen, is set.

To change to "On-Screen", where you perform operations while having the iPod information displayed on the TV screen, see "Setting operation mode (iPod Browse Mode)" ([page 32](#)).

1 Using the USB cable provided with the iPod, connect the iPod to the USB port ([page 16](#)).

2 Press **POWER**  to turn on power to the unit.

3 Press **iPod/USB** to switch the input source to "iPod/USB". "Browse From iPod" is displayed on the display of this unit.

- Nothing is displayed on the TV screen.

4 Operate iPod itself directly while seeing the iPod screen to play back music.



- Streaming music stored in iPhone, iPod touch, or iPad directly to the unit ([page 70](#))
- Playing iTunes music with this unit ([page 70](#))

Operations available through the OPTION button

Press the **OPTION** button to display a menu of functions that can be used on the TV screen. Select the function you want to use from this menu. You can easily find and use the desired function.

Performing repeat playback (Repeat) ([page 33](#))

Performing random playback (Random) ([page 33](#))

Setting operation mode (iPod Browse Mode) ([page 32](#))

Displaying your desired video on the monitor during audio playback (Video Select) ([page 68](#))

Adjusting the picture quality for your viewing environment (Picture Mode) ([page 68](#))

All Zone Stereo function ([page 69](#))

Setting operation mode (iPod Browse Mode)

In this mode, various lists and screens during playback on the iPod are displayed on the TV screen. This section describes the steps up to playing back tracks on the iPod in "On-Screen".

1 Press iPod/USB to switch the input source to "iPod/USB".

2 Press OPTION.
The option menu screen is displayed.

3 Select "iPod Browse Mode", then press ENTER.
The "iPod Browse Mode" screen is displayed.

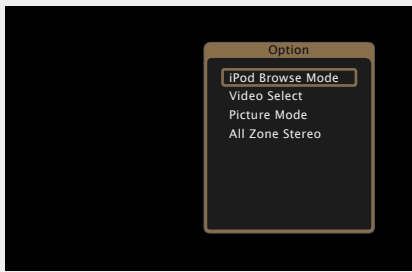

4 Use < and > to select "On-Screen", then press ENTER.
The iPod screen is displayed.

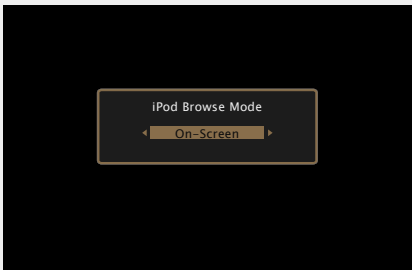

- English letters, numbers and certain symbols are displayed. Incompatible characters are displayed as "." (period).
- Operations available for "On-Screen" and "From iPod" are listed below.

Display mode		From iPod	On-Screen
Playable files	Music file	✓	✓
	Video file	*	
Active buttons	Remote control unit (This unit)	✓	✓
	iPod	✓	

* Only the sound is played.

5 Use Δ and ∇ to select the item, then press ENTER or > to select the file to be played.

6 Press ENTER, > or >||.
Playback starts.

Adjusting the sound quality (M-DAX)

Make this setting at "M-DAX" (page 111) in the menu. You can use the M-DAX function to improve the fidelity of compressed audio sources such as MP3 files. The M-DAX has selectable levels of restoration. The default setting is "Off".

Changing the screen display duration

Make this setting at "Now Playing" (page 118) in the menu. The default setting is "Always On". When "Auto Off" is set, the on-screen display is turned off 30 seconds after an operation. Press Δ∇< > while the display is off to return to the original screen.

Switching the screen display

Press **STATUS** on this unit during playback with "iPod Browse Mode" set to "On-Screen". The display switches between track title, artist name, and album title etc. each time the button is pressed.

NOTE

- Depending on the type of iPod and the software version, some functions may not operate.
- Note that Marantz will accept no responsibility whatsoever for any problems arising with the data on an iPod when using this unit in conjunction with the iPod.

Performing repeat playback (Repeat)

1 Press **OPTION** with “iPod Browse Mode” set to “On-Screen”.
The option menu screen is displayed.

2 Use Δ / ∇ to select “Repeat”, then press **ENTER**.

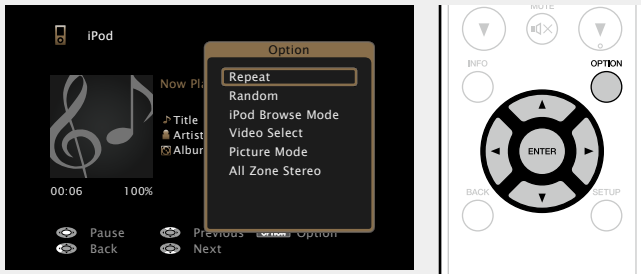

3 Use \triangleleft / \triangleright to select repeat playback mode.

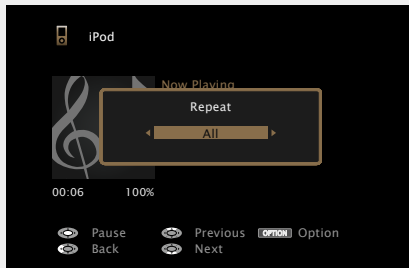

• Each time \triangleleft / \triangleright is pressed, the setting is changed as shown below.

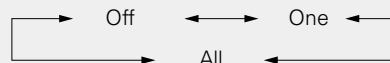

- Off** Repeat playback mode is canceled.
- One** A file being played is played repeatedly.
- All** All files in the folder currently being played are played repeatedly.

4 Press **ENTER**.
The display returns to the playback screen.

Performing random playback (Random)

1 Press **OPTION** with “iPod Browse Mode” set to “On-Screen”.
The option menu screen is displayed.

2 Use Δ / ∇ to select “Random”, then press **ENTER**.

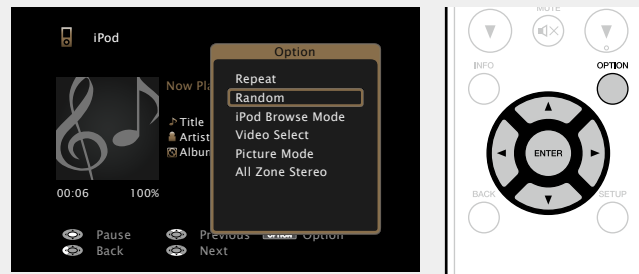

3 Use \triangleleft / \triangleright to select random playback mode.

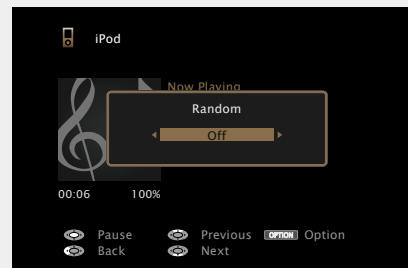

• Each time \triangleleft / \triangleright is pressed, the setting is changed as shown below.



- Off** Disable random playback.
- On** Randomly play back all tracks in the current playback folder.

4 Press **ENTER**.
The display returns to the playback screen.



During random playback, each time playback of a track is completed, another track is randomly selected for playback from tracks in the folder. Therefore, it's possible that you may hear a track played back more than once during random playback.

iPod operation buttons

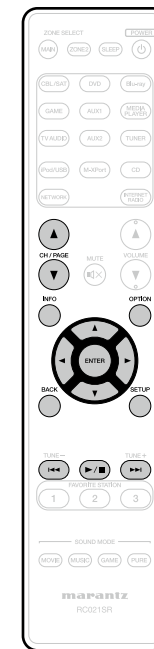

Operation buttons	Function
CH/PAGE Δ / ∇	Page search
INFO	Display of information such as the source name, volume, and sound mode name
OPTION	Repeat playback / Random playback / iPod Browse Mode switching / Video Select / Picture Mode / All Zone Stereo
Δ / ∇ / \triangleleft / \triangleright	Cursor operation / Next/Previous (Δ / ∇) / Fast-forward/Fast-reverse (Press and hold, Δ / ∇)
ENTER (Press and release)	Enter / Playback / Pause
ENTER (Press and hold)	Stop
BACK	Return
SETUP	Setup menu
\lll / \ggg (Press and release)	Next/Previous
\lll / \ggg (Press and hold)	Fast-forward/Fast-reverse
\blacktriangleright / II	Playback / Pause

Playing a USB memory device

Playing back music or viewing still picture (JPEG) files stored on a USB memory device.

Important information

- Only USB memory devices conforming to mass storage class and MTP (Media Transfer Protocol) standards can be played on this unit.
- This unit is compatible with USB memory devices in "FAT16" or "FAT32" format.
- This unit is compatible with MP3 files conforming to "MPEG-1 Audio Layer-3" standards.
- File types that this unit can play back and specifications are shown below.

[Supported file types]

Supported file types	USB memory devices *1
WMA (Windows Media Audio)	✓*2
MP3 (MPEG-1 Audio Layer-3)	✓
WAV	✓
MPEG-4 AAC	✓*3
FLAC (Free Lossless Audio Codec)	✓
JPEG	✓
ALAC (Apple Lossless Audio Codec)	✓

*1 USB memory device

- This unit is compatible with MP3 ID3-Tag (Ver. 2) standard.
- This unit can show the artwork that was embedded by using MP3 ID3-Tag Ver. 2.3 or 2.4.
- This unit is compatible with WMA META tags.
- If the image size (pixels) of an album artwork exceeds 500 × 500 (WMA/MP3/WAV/FLAC) or 349 × 349 (MPEG-4 AAC), then music may not be played back properly.
- WAV format Quantization bit length: 16 or 24 bits.
- FLAC format Quantization bit length: 16 or 24 bits.

*2 Copyright-protected files can be played on certain portable players compatible with MTP.

*3 Only files that are not protected by copyright can be played on this unit.

Content downloaded from pay sites on the Internet are copyright protected. Also, files encoded in WMA format when ripped from a CD, etc. on a computer may be copyright protected, depending on the computer's settings.

NOTE

File types that this unit does not support are not displayed.

[Compatible formats]

	Sampling frequency	Bit rate	Extension
WMA (Windows Media Audio)	32/44.1/48 kHz	48 – 192 kbps	.wma
MP3 (MPEG-1 Audio Layer-3)	32/44.1/48 kHz	32 – 320 kbps	.mp3
WAV	32/44.1/48/88.2/96/ 176.4/192 kHz	–	.wav
MPEG-4 AAC	32/44.1/48 kHz	16 – 320 kbps	.aac/ .m4a/ .mp4
FLAC (Free Lossless Audio Codec)	32/44.1/48/88.2/96/ 176.4/192 kHz	–	.flac
ALAC (Apple Lossless Audio Codec)*	32/44.1/48/88.2/96 kHz	–	.m4a

* Copyright [2012] [D&M Holdings. Inc.]

Licensed under the Apache License, Version 2.0 (the "License"); you may not use this file except in compliance with the License. You may obtain a copy of the License at <http://www.apache.org/licenses/LICENSE-2.0>

□ Maximum Number of Playable Files and Folder

The limits on the number of folders and files that can be displayed by this unit are as follows.

Item	Media	USB memory devices
Memory capacity		FAT16 : 2 GB, FAT32 : 2 TB
Number of folder directory levels *1		8 levels
Number of folders		500
Number of files *2		5000

*1 The limited number includes the root folder.

*2 The allowable number of files may differ according to the USB memory device capacity and the file size.

Playing files stored on USB memory devices

1 Connect the USB memory device to the USB port (page 16).

2 Press iPod/USB to switch the input source to “iPod/USB”.

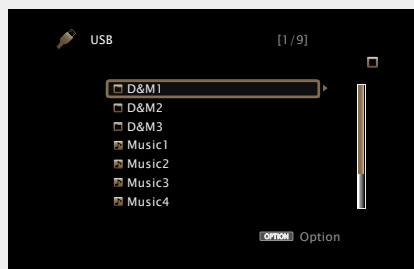

3 Use Δ / ∇ to select the search item or folder, then press ENTER or \triangleright .

4 Use Δ / ∇ to select the file, then press ENTER, \triangleright or \blacktriangleright /II. Playback starts.



Adjusting the sound quality (M-DAX)

Make this setting at “M-DAX” (page 111) in the menu.

You can use the M-DAX function to improve the fidelity of compressed audio sources such as MP3 files. The M-DAX has selectable levels of restoration. The default setting is “Off”.

Going back to the previous screen

Press \triangleleft or **BACK**.

Changing the screen display duration

Make this setting at “Now Playing” (page 118) in the menu. The default setting is “Always On”.

When “Auto Off” is set, the on-screen display is turned off 30 seconds after an operation.

Press Δ / ∇ / \triangleleft \triangleright while the display is off to return to the original screen.



- When an MP3 music file includes album art data, the album art can be displayed while playing the file.
- If the USB memory device is divided into multiple partitions, only the first partition is played back.

NOTE

- Note that Marantz will accept no responsibility whatsoever for any problems arising with the data on a USB memory device when using this unit in conjunction with the USB memory device.
- USB memory devices will not work via a USB hub.
- Marantz does not guarantee that all USB memory devices will operate or be supplied power. When using a USB portable hard disk that can draw power from an AC adapter, we recommend using the AC adapter.
- It is not possible to connect and use a computer via the USB port of this unit using a USB cable.

Operations available through the OPTION button

Press the **OPTION** button to display a menu of functions that can be used on the TV screen. Select the function you want to use from this menu. You can easily find and use the desired function.

Searching content with keywords
(Text Search) (page 64)

Performing repeat playback (Repeat)
(page 64)

Performing random playback (Random)
(page 65)

Playing back still images in sequential order
(Slideshow Interval) (page 67)

Displaying your desired video on the monitor during audio playback (Video Select) (page 68)

Adjusting the picture quality for your viewing environment (Picture Mode) (page 68)

All Zone Stereo function (page 69)

□ USB memory device operation buttons

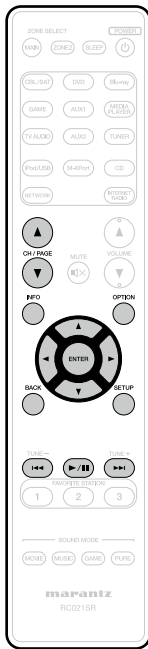

Operation buttons	Function
CH/PAGE ▲▼	Page search
INFO	Display of information such as the source name, volume, and sound mode name etc.
OPTION	Text Search / Repeat playback / Random playback / Slideshow Interval / Video Select / Picture Mode / All Zone Stereo
△▽◀▶	Cursor operation / Next/Previous (△▽) / Fast-forward/Fast-reverse (Press and hold, △▽)*
ENTER (Press and release)	Enter
ENTER (Press and hold)	Stop
BACK	Return
SETUP	Setup menu
⏪ ⏩ (Press and release)	Next/Previous
⏪ ⏩ (Press and hold)	Fast-forward/Fast-reverse*
▶	Playback / Pause

* This function is available while an MP3 / WAV / AAC / FLAC file is being played back.

Listening to FM/AM broadcasts

For antenna connections, see “Connecting an FM/AM antenna” (page 18).

How to tune in

The modes for receiving FM broadcasts consists of “Auto” mode that automatically searches available broadcast stations and “Manual” mode that lets you tune in using buttons to change the frequency. The default setting is “Auto”. You can also use “Direct Tune” to tune in by entering the frequency directly.

In “Auto” mode, you cannot tune in to radio stations if the reception is not good. If this is the case, then use the “Manual” mode or “Direct Tune” to tune in.

Listening to FM/AM broadcasts

1 Press **TUNER** to switch the input source to “TUNER”.

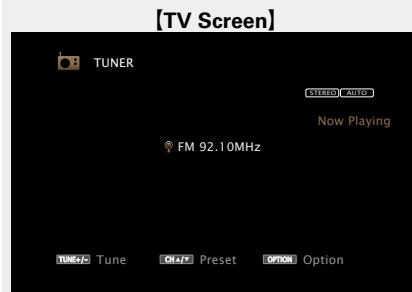

[TV Screen]

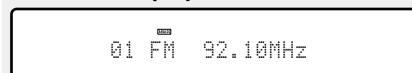

2 Press **OPTION**.
The option menu screen is displayed.

3 Use Δ / ∇ to select “FM/AM”, then press **ENTER**.
The Band screen is displayed.

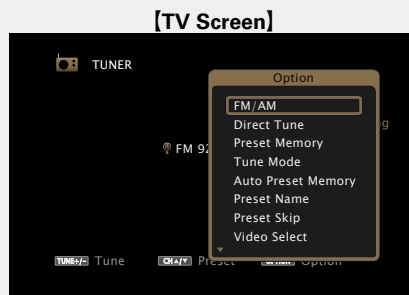

[TV Screen]

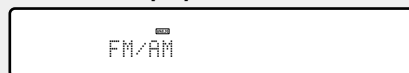

4 Use \triangleleft / \triangleright to select “FM” or “AM”, then press **ENTER**.

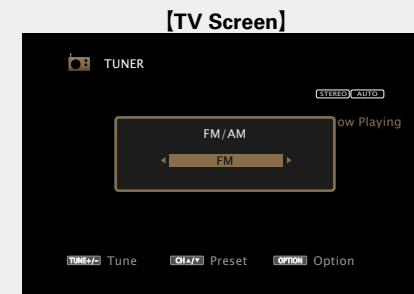

[TV Screen]

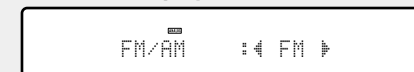

FM When listening to an FM broadcast.

AM When listening to an AM broadcast.

5 Press **TUNE +** or **TUNE -** to select the station you want to hear.

Scanning is performed until it finds an available radio station. When it finds a radio station, it stops the scan automatically and tunes in.



- If the desired station cannot be tuned in with auto tuning, tune it in manually.
- When tuning in stations manually, press and hold **TUNE +** or **TUNE -** to change frequencies continuously.

❑ Changing the screen display duration

Make this setting at “Now Playing” ([page 118](#)) in the menu. The default setting is “Always On”.

When “Auto Off” is set, the on-screen display is turned off 30 seconds after an operation.

Press $\Delta \nabla \triangleleft \triangleright$ while the display is off to return to the original screen.

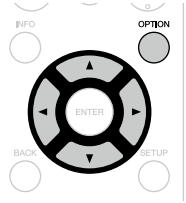

❑ Adding to the FAVORITE STATION button

([page 66](#))

Operations available through the OPTION button

Press the **OPTION** button to display a menu of functions that can be used on the TV screen. Select the function you want to use from this menu. You can easily find and use the desired function.

❑ **Tuning in by entering the radio frequency (Direct Tune)** ([page 39](#))

❑ **Presetting the current broadcast station (Preset Memory)** ([page 40](#))

❑ **Changing the tuning mode (Tune Mode)** ([page 41](#))

❑ **Tuning in to radio stations and presetting them automatically (Auto Preset Memory)** ([page 42](#))

❑ **Specify a name for the preset broadcast station (Preset Name)** ([page 43](#))

❑ **Skipping preset broadcast stations (Preset Skip)** ([page 44](#))

❑ **Displaying your desired video on the monitor during audio playback (Video Select)** ([page 68](#))

❑ **All Zone Stereo function** ([page 69](#))

□ Tuning in by entering the radio frequency (Direct Tune)

You can enter the receiving frequency directly to tune in.

1 Press **TUNER** to switch the input source to “TUNER”.

2 Press **OPTION**.
The option menu screen is displayed.

3 Use Δ / ∇ to select “Direct Tune”, then press **ENTER**.
The direct tuner screen is displayed and “_” in the display flashes.

[TV Screen]

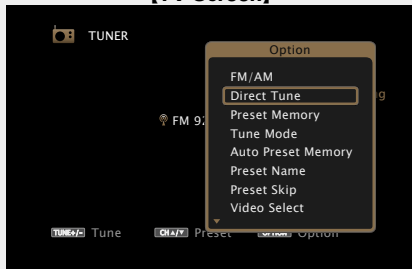

[Display of this unit]

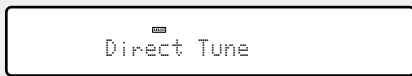

4 Use Δ / ∇ to select a number and press \triangleright .
The screen that lets you enter the frequency is displayed.

[TV Screen]

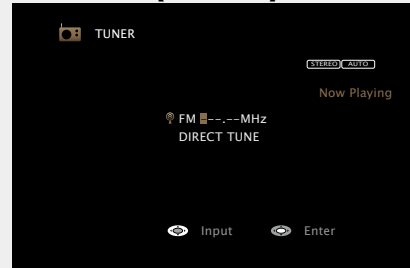

[Display of this unit]

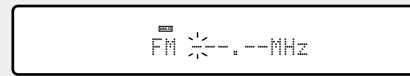
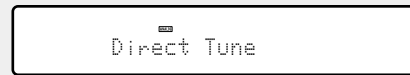

• If \triangleleft is pressed, the immediately preceding input is cancelled.

5 Repeat step 4 and enter the frequency of the radio station you want to hear.

6 When setting is completed, press **ENTER**.
The preset frequency is tuned in.

❑ Presetting the current broadcast station (Preset Memory)

Your favorite broadcast stations can be preset so that you can tune them in easily. Up to 56 stations can be preset.

1 Tune in the broadcast station you want to preset.

2 Press **OPTION**.
The option menu screen is displayed.

3 Use $\Delta \nabla$ to select “Preset Memory”, then press **ENTER**.
The list of already preset channels is displayed.

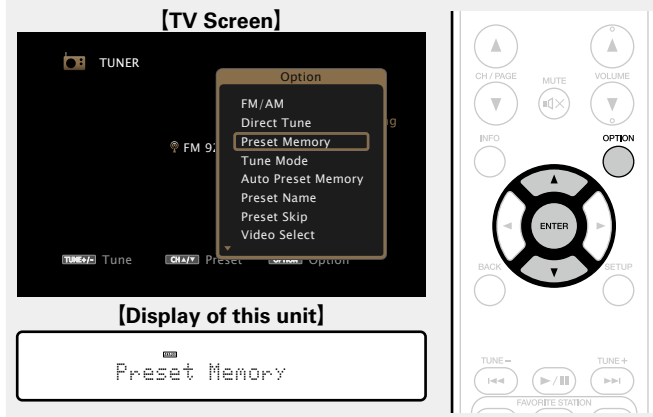

4 Use $\Delta \nabla$ to select the channel you want to preset, then press **ENTER**.

The current broadcast station that is preset.

- To preset other stations, repeat steps 1 to 4.

[TV Screen]

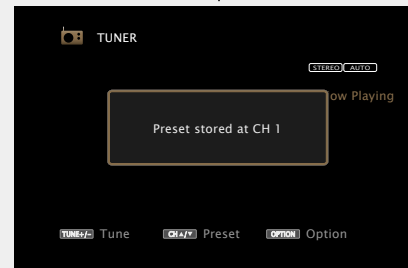
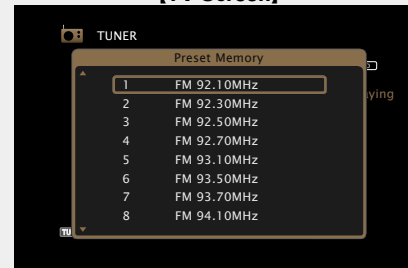

[Display of this unit]

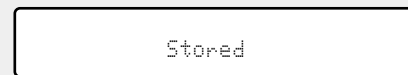
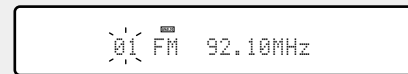

The channel numbers of broadcast stations set as “Preset Skip” (page 44) are grayed out, but these stations can be preset. When grayed out channel numbers are preset, these are highlighted and the “Preset Skip” setting changes to “On”.

Channel	Default settings
1 – 8	92.10 / 92.30 / 92.50 / 92.70 / 93.10 / 93.50 / 93.70 / 94.10 MHz
9 – 16	94.30 / 94.50 / 94.70 / 94.90 / 95.10 / 95.30 / 95.50 / 95.70 MHz
17 – 24	98.10 / 98.30 / 98.50 / 98.70 / 98.90 / 99.10 / 100.10 / 100.30 MHz
25 – 32	100.50 / 100.70 / 100.90 / 101.10 / 101.30 / 101.50 / 101.70 / 101.90 MHz
33 – 40	103.10 / 103.30 / 103.50 / 103.70 / 103.90 / 104.10 / 104.30 / 104.50 MHz
41 – 48	104.70 / 104.90 / 105.10 / 105.30 / 105.50 / 105.70 / 105.90 / 106.10 MHz
49 – 56	106.30 / 106.50 / 106.70 / 106.90 / 107.10 / 107.30 / 107.50 / 107.90 MHz

Listening to preset stations

Use **CH/PAGE** $\Delta \nabla$ to select the desired preset channel.

[Display of this unit]

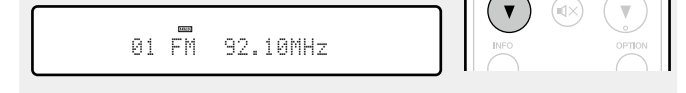

Changing the tuning mode (Tune Mode)

You can change the mode for tuning into FM broadcasts. If you cannot tune in automatically with "Auto" mode, then change the mode to "Manual" and tune in manually.

1 Press **TUNER** to switch the input source to "TUNER".

2 Press **OPTION**.
The option menu screen is displayed.

3 Use Δ / ∇ to select "Tune Mode", then press **ENTER**.

[TV Screen]

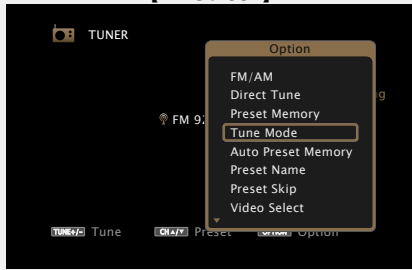

[Display of this unit]

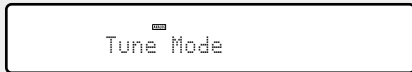

4 Use \triangleleft / \triangleright to select tuning mode, then press **ENTER**.

[TV Screen]

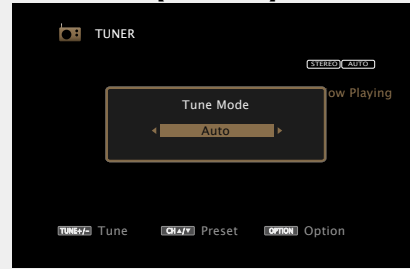

[Display of this unit]

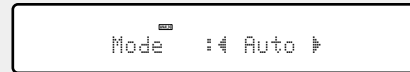

Auto Automatically tune to the station.

Manual Manually tune to the station.



When tuning in stations manually, press and hold **TUNE +** or **TUNE -** to change frequencies continuously.

□ Tuning in to radio stations and presetting them automatically (Auto Preset Memory)

Up to 56 stations can be preset.
 If "Auto Preset Memory" is performed after performing "Preset Memory", the "Preset Memory" settings will be overwritten.

1 Press **TUNER** to switch the input source to "TUNER".

2 Press **OPTION**.
 The option menu screen is displayed.

3 Use Δ / ∇ to select "Auto Preset Memory", then press **ENTER**.

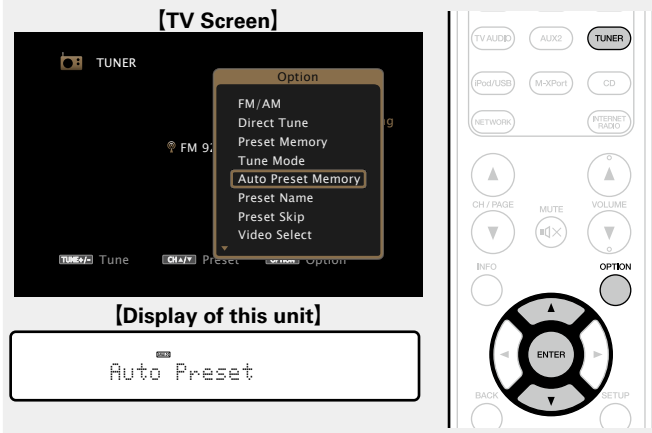

4 Press **ENTER**.
 The unit starts to tune in to radio stations automatically and preset them.

[TV Screen]

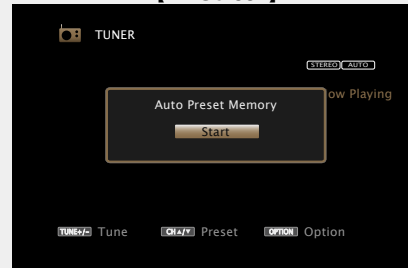

[Display of this unit]

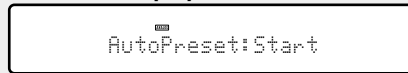

- When presetting is completed, "Completed" is displayed for about 5 seconds and the option menu screen turns off.

Specify a name for the preset broadcast station (Preset Name)

You can set the name to the preset broadcast station or change it. Up to eight characters can be input.

1 Press **TUNER** to switch the input source to “TUNER”.

2 Press **OPTION**.
The option menu screen is displayed.

3 Use $\Delta \nabla$ to select “Preset Name”, then press **ENTER**.
The Preset Name screen is displayed.

[TV Screen]

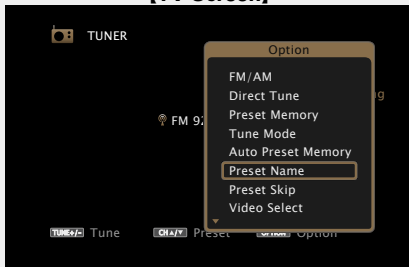

[Display of this unit]

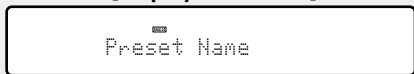

4 Use $\triangleleft \triangleright$ to select the group of the broadcast station you want to name then press **ENTER**.

The screen that lets you edit the preset name is displayed.

- Each time $\triangleleft \triangleright$ is pressed, the setting is changed as shown below.

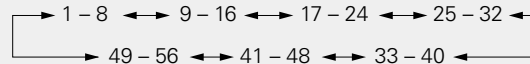

[TV Screen]



[Display of this unit]

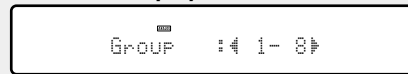

5 Use $\Delta \nabla$ to select the broadcast station you want to name, then press **ENTER**.

[TV Screen]

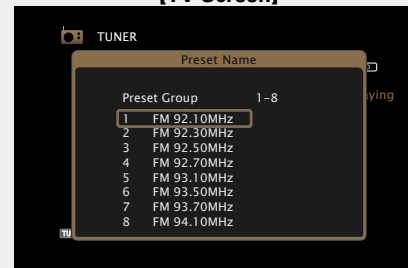

[Display of this unit]

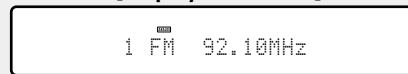

6 Use $\Delta \nabla$ to select a name label, then press **ENTER**.

The screen that lets you edit the preset name is displayed.

- If you select “Set Defaults”, then the unit returns to displaying the frequency.

7 Enter the characters, then press **OK**.

- For character input, see [page 107](#).

8 Press **BACK** twice.

The display returns to the playback screen.

❑ Skipping preset broadcast stations (Preset Skip)

You can set in advance, the stations you do not want to be displayed when tuning in, by groups or by stations.
The preset skip setting is useful when tuning in, because only your favorite stations are displayed.

1 Press **TUNER** to switch the input source to “TUNER”.

2 Press **OPTION**.
The option menu screen is displayed.

3 Use $\Delta \nabla$ to select “Preset Skip”, then press **ENTER**.
The Preset Skip screen is displayed.

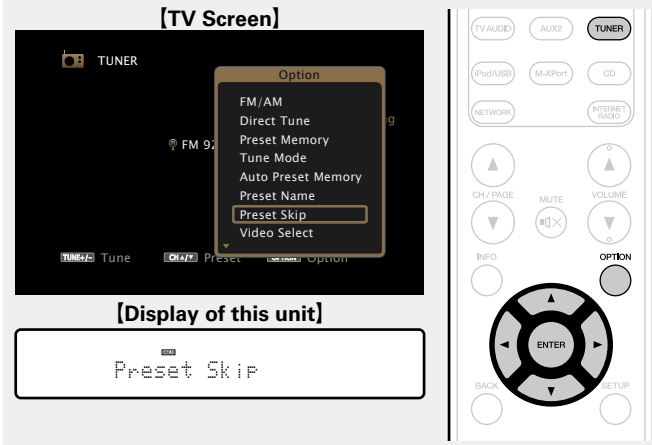

4-1 [To set the stations you want to skip by groups]

① Use $\triangleleft \triangleright$ to select the group of broadcast stations you want to skip.

- Each time $\triangleleft \triangleright$ is pressed, the setting is changed as shown below.

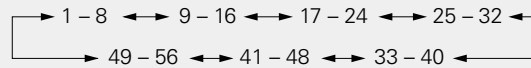

- ② Press Δ to select “Set No.* - * to Skip”, then press **ENTER**.
All broadcast stations in the group “* - *” you selected are not displayed.
(* are the selected group numbers)
- ③ Press **BACK**.

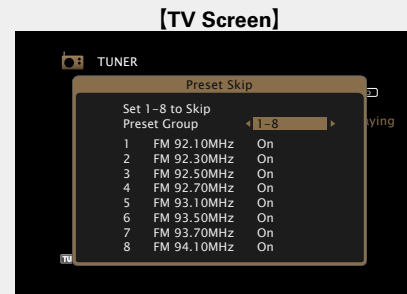

[Display of this unit]

Set 1- 8to Skip

4-2 [To set the stations you want to skip by stations]

① Use $\triangleleft \triangleright$ to select the group of broadcast stations you want to skip.

- Each time $\triangleleft \triangleright$ is pressed, the setting is changed as shown below.

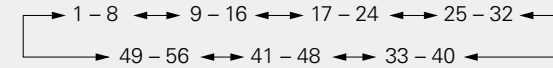

- ② Use $\Delta \nabla$ to select the broadcast station you want to skip.
- ③ Use $\triangleleft \triangleright$ to select “Skip”.
The station you selected is not displayed.
- ④ Press **BACK**.

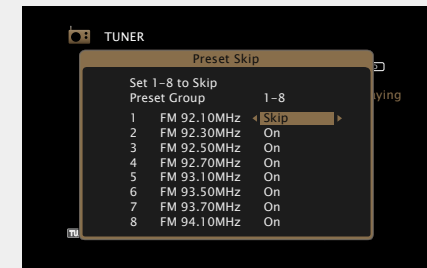
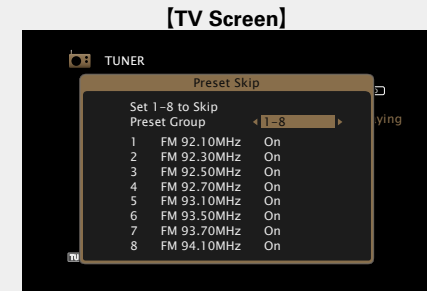

[Display of this unit]

1 92.10M:45kpf

❑ Cancelling preset skip

1 While the Preset Skip screen is displayed, use ◀ ▶ to select a group containing a broadcast station to cancel the skip for.

2 Use △ ▽ to select a broadcast station to cancel the skip for.

[TV Screen]

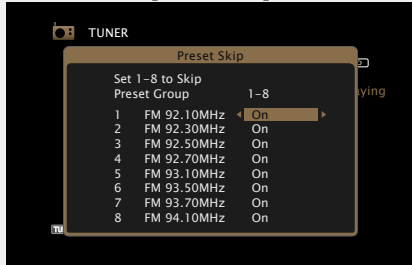

[Display of this unit]

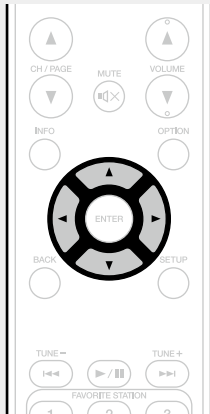
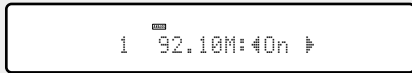

3 Use ◀ ▶ to select “On”.
The skip is cancelled.

NOTE

You cannot cancel the skip for each group.

❑ Tuner operation buttons

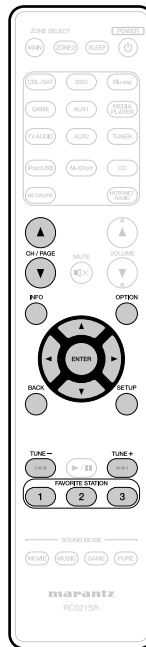

Operation buttons	Function
FAVORITE STATION 1 – 3	Call up favorite stations
FAVORITE STATION 1 – 3 (Press and hold)	Add to the favorite stations
CH/PAGE ▲▼	Preset channel selection
INFO	Display of information such as the source name, volume, and sound mode name
OPTION	FM/AM switching Direct frequency tuning / Preset Memory / Switch tuning modes / Auto Preset Memory / Preset Name / Preset Skip / Video Select / All Zone Stereo
△▽◀▶	Cursor operation
ENTER	Enter
BACK	Return
SETUP	Setup menu
TUNE +, –	Tuning (up/down)

Network content

Listening to Internet Radio

Internet Radio refers to radio broadcasts distributed over the Internet. Internet Radio stations from around the world can be received.

Important information

The broadcast station types and specifications supported by this unit for playback are as follows.

[Playable broadcast station types]

Supported file types	Internet Radio
WMA (Windows Media Audio)	✓
MP3 (MPEG-1 Audio Layer-3)	✓

[Playable broadcast station specifications]

	Sampling frequency	Bit rate	Extension
WMA (Windows Media Audio)	32/44.1/48 kHz	48 – 192 kbps	.wma
MP3 (MPEG-1 Audio Layer-3)	32/44.1/48 kHz	32 – 320 kbps	.mp3

Listening to Internet Radio

1 Prepare for playback.

- ① Check the network environment, then turn on this unit's power (☞ [page 20](#) "Connecting to a home network (LAN)").
- ② If settings are required, make the "Settings" (☞ [page 129](#)).

2 Press NETWORK.

- You can also press **INTERNET RADIO** to select the input source "Internet Radio" directly.

3 Use Δ ∇ \triangleleft \triangleright to select "Internet Radio", then press ENTER.

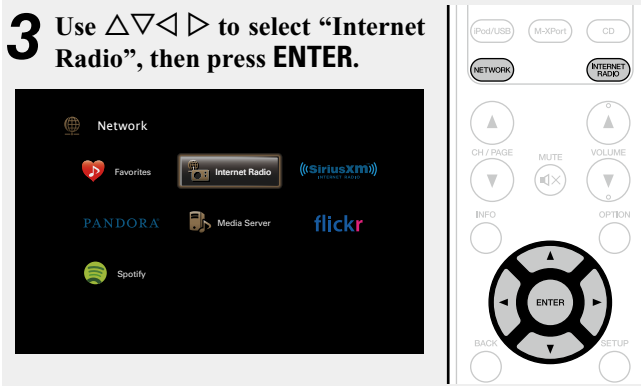

4 Use Δ ∇ to select the item you want to play, then press ENTER or \triangleright .



- ******* (Country name) Displays typical Internet Radio stations your country.
- Search Stations** Displays all Internet Radio stations that this unit can tune in to.
- Search Podcasts** Displays Internet Radio stations in the podcasts that this unit can tune in to.
- Recommended Stations** Displays recommended Internet Radio stations.
- radiomarantz.com** Displays Internet Radio stations added to favorites in vTuner. For instructions on how to add to favorites in vTuner, see "Using vTuner to add Internet Radio stations to favorites" (☞ [page 48](#)).
- Recently Played** Displays recently played Internet Radio stations. Up to 20 stations stored in "Recently Played".
- Search by Keyword** Displays Internet Radio stations searched by keyword. For character input, see [page 107](#).

5 Repeat step 4 until the station list is displayed.

The station list is displayed.

6 Use Δ ∇ to select the station, then press ENTER or \triangleright .

Playback starts once buffering reaches "100%".

❑ Adjusting the sound quality (M-DAX)

Make this setting at "M-DAX" ([page 111](#)) in the menu.

You can use the M-DAX function to improve the fidelity of compressed audio sources such as content from Internet Radio stations. The M-DAX has selectable levels of restoration. The default setting is "Off".

❑ Switching the screen display

Press **STATUS** on the main unit.

The display switches between track title and radio station name etc. each time the button is pressed.

❑ Going back to the previous screen

Press ◀ or **BACK**.

❑ Changing the screen display duration

Make this setting at "Now Playing" ([page 118](#)) in the menu. The default setting is "Always On".

When "Auto Off" is set, the on-screen display is turned off 30 seconds after an operation.

Press △▽◀▶ while the display is off to return to the original screen.



- There are many Internet Radio stations on the Internet, and the quality of the programs they broadcast as well as the bit rate of the tracks varies widely.

Generally, the higher the bit rate, the higher the sound quality, but depending on the communication lines and server traffic, the music or audio signals being streamed may be interrupted. Inversely, lower bit rates mean a lower sound quality but less tendency for the sound to be interrupted.

- "Radio station server full" or "Connection down" is displayed if the station is busy or not broadcasting.
- On this unit, folder and file names can be displayed as titles. Any characters that cannot be displayed are replaced with "." (period).

NOTE

The radio station database service may be suspended or be otherwise unavailable without notice.

Operations available through the OPTION button

Press the **OPTION** button to display a menu of functions that can be used on the TV screen. Select the function you want to use from this menu. You can easily find and use the desired function.

❑ **Searching content with keywords (Text Search)** ([page 64](#))

❑ **Add to favorites from the Option menu (Save to Favorites)** ([page 66](#))

❑ **Playing back music and a favorite picture at the same time (Slideshow)** ([page 67](#))

❑ **Displaying your desired video on the monitor during audio playback (Video Select)** ([page 68](#))

❑ **Adjusting the picture quality for your viewing environment (Picture Mode)** ([page 68](#))

❑ **All Zone Stereo function** ([page 69](#))

❑ Playing the last played Internet Radio station

This unit memorizes the last played Internet Radio station. If you press **INTERNET RADIO** to switch to the Internet Radio function from another input source, the last Internet Radio station you listened to is played.

Press INTERNET RADIO.

The source switches to "Internet Radio" and the last played radio station plays.

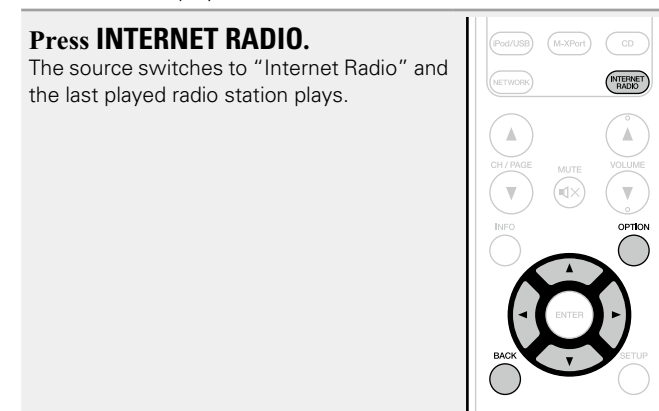

This can also be set by pressing **INTERNET RADIO** on the main unit.

❑ Using vTuner to add Internet Radio stations to favorites

There are many Internet Radio stations in the world, and this unit can tune into these stations. But finding the radio station you want to hear may be difficult, because there are too many stations. If this is the case, then please use vTuner, an Internet Radio station search website specifically designed for this unit. You can use your PC to search Internet Radio stations and add them as your favorites. This unit can play radio stations added to vTuner.

1 Check the MAC address of this unit (page 128).

The screen that lets you edit the preset name is displayed.
MAC address:

- The MAC address is necessary when you create an account for vTuner.

2 Use your PC to access the vTuner website (<http://www.radiomarantz.com>).

The vTuner login screen is displayed.

3 Enter the MAC address of this unit, then click “Go”.

The account creation screen is displayed.

4 Enter your E-mail address and a password of your choice.

The account is registered and you can now log in.

5 Enter your account information (E-mail address and password) and log in.

The top menu of vTuner is displayed.

6 Select the search criteria (genre, region, language, etc.) of your choice.

The list of radio stations matching the criteria is displayed.

- You can also enter a keyword to search for a station you want to hear.

7 Select the radio station of your choice from the list, and then click the Add to Favorites icon.

The screen that lets you create a favorite group is displayed.

8 Enter the name of the favorite group, then click “Go”.

A new favorite group that includes the selected radio station is created.

- Internet Radio stations added to favorites in vTuner can be played from “radiomarantz.com” (page 46) with this unit.

❑ Internet Radio operation buttons

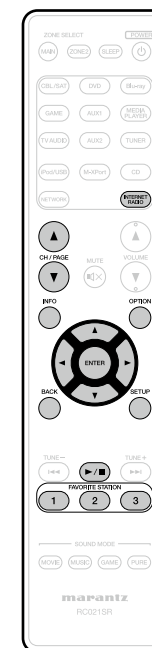

Operation buttons	Function
INTERNET RADIO	Last played Internet Radio station
CH/PAGE ▲▼	Page search
INFO	Display of information such as the source name, volume, and sound mode name
OPTION	Text Search / Save to Favorites / Slideshow / Video Select / Picture Mode / All Zone Stereo
△▽◀▶	Cursor operation
ENTER (Press and release)	Enter
ENTER (Press and hold)	Stop
BACK	Return
SETUP	Setup menu
▶/ 	Playback / Stop
FAVORITE STATION 1 – 3	Call up favorite stations
FAVORITE STATION 1 – 3 (Press and hold)	Add to the favorite stations

Playing back files stored on a PC and NAS

This unit can play back music files and playlists (m3u, wpl) stored on a PC and on Network Attached Storage (NAS) that supports DLNA.

Important information

- The network audio playback function of this unit connects to the server using technologies shown below.
 - Windows Media Player Network Sharing Service
 - Windows Media DRM10
- File types that this unit can play back and specifications are shown below.

[Supported file types]

Supported file types	Media Server *1
WMA (Windows Media Audio)	✓
MP3 (MPEG-1 Audio Layer-3)	✓
WAV	✓
MPEG-4 AAC	✓*2
FLAC (Free Lossless Audio Codec)	✓
JPEG	✓
ALAC (Apple Lossless Audio Codec)	✓

A server or server software compatible with distribution in the corresponding formats is required to play music files via a network.

*1 Media Server

- This unit is compatible with MP3 ID3-Tag (Ver. 2) standard.
- This unit can show the artwork that was embedded by using MP3 ID3-Tag Ver. 2.3 or 2.4.
- This unit is compatible with WMA META tags.
- If the image size (pixels) of an album artwork exceeds 500 × 500 (WMA/MP3/WAV/FLAC) or 349 × 349 (MPEG-4 AAC), then music may not be played back properly.
- WAV format Quantization bit length: 16 or 24 bits.
- FLAC format Quantization bit length: 16 or 24 bits.

*2 Only files that are not protected by copyright can be played on this unit.

Content downloaded from pay sites on the Internet are copyright protected. Also, files encoded in WMA format when ripped from a CD, etc. on a computer may be copyright protected, depending on the computer's settings.

NOTE

File types that this unit does not support are not displayed.

[Specifications of supported files]

	Sampling frequency	Bit rate	Extension
WMA (Windows Media Audio)	32/44.1/48 kHz	48 – 192 kbps	.wma
MP3 (MPEG-1 Audio Layer-3)	32/44.1/48 kHz	32 – 320 kbps	.mp3
WAV	32/44.1/48/88.2/96/ 176.4/192 kHz	–	.wav
MPEG-4 AAC	32/44.1/48 kHz	16 – 320 kbps	.aac/ .m4a/ .mp4
FLAC (Free Lossless Audio Codec)	32/44.1/48/88.2/96/ 176.4/192 kHz	–	.flac
ALAC (Apple Lossless Audio Codec)*	32/44.1/48/88.2/96 kHz	–	.m4a

* Copyright [2012] [D&M Holdings. Inc.]

Licensed under the Apache License, Version 2.0 (the "License"); you may not use this file except in compliance with the License. You may obtain a copy of the License at <http://www.apache.org/licenses/LICENSE-2.0>

Applying media sharing settings

Here, we apply the settings to share music files stored on a PC and NAS on the network.

Sharing media stored in PC

If you are using a Media Server, be sure to apply this setting first.

When using Windows Media Player 12 (Windows 7 / Windows 8)

NOTE

Perform this procedure after changing the control panel display to "Category".

- 1** In the PC's "Control Panel", select "Network and Internet" - "Choose homegroup and sharing options".
- 2** Select the "Stream my pictures, music, and videos to all devices on my home network" check box and select "Choose media streaming options".
- 3** Select "Allowed" in the drop-down list for "NR1604".
- 4** Select "Allowed" in the drop-down list for "Media programs on this PC and remote connections...".
- 5** Click "OK" to finish.

When using Windows Media Player 11

- 1** Start up Windows Media Player 11 on the PC.
- 2** Select "Media Sharing" in the "Library".
- 3** Click the "Share my media" check box, select "NR1604", and then click "Allow".
- 4** As you did in step 3, select the icon of the device (other PCs and mobile devices) you want to use as a media controller, and then click "Allow".
- 5** Click "OK" to finish.

Sharing media stored in NAS

Change settings on the NAS to allow this unit and other devices (PCs and mobile devices) used as media controllers to access the NAS. For details, see the owner's manual that came with the NAS.

Playing back files stored on a PC and NAS

Use this procedure to play music files, image files or playlists.

1 Prepare for playback.

- ① Check the network environment, then turn on this unit's power (☞ [page 20](#) "Connecting to a home network (LAN)").
- ② If settings are required, make the "Settings" (☞ [page 129](#)).
- ③ Prepare the computer (☞ Computer's operating instructions).

2 Press NETWORK.

3 Use $\Delta \nabla \triangleleft \triangleright$ to select "Media Server", then press ENTER.

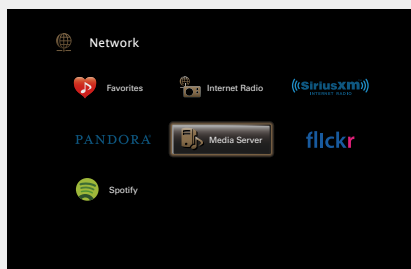

4 Use $\Delta \nabla$ to select the server including the file to be played, then press ENTER or \triangleright .

5 Use $\Delta \nabla$ to select the search item or folder, then press ENTER or \triangleright .

6 Repeat step 4 until the file is displayed.

7 Use $\Delta \nabla$ to select the file, then press ENTER or \triangleright . Playback starts once buffering reaches "100%".

☐ Adjusting the sound quality (M-DAX)

Make this setting at "M-DAX" (☞ [page 111](#)) in the menu.

You can use the M-DAX function to improve the fidelity of compressed audio sources such as MP3 files. The M-DAX has selectable levels of restoration. The default setting is "Off".

☐ Switching the screen display

Press **STATUS** on the main unit.

The display switches between track title, artist name, and album title each time the button is pressed.

☐ Going back to the previous screen

Press \triangleleft or **BACK**.

☐ Changing the screen display duration

Make this setting at "Now Playing" (☞ [page 118](#)) in the menu. The default setting is "Always On".

When "Auto Off" is set, the on-screen display is turned off 30 seconds after an operation.

Press $\Delta \nabla \triangleleft \triangleright$ while the display is off to return to the original screen.



- When a WMA (Windows Media Audio), MP3 or MPEG-4 AAC file includes album art data, the album art can be displayed while the music files are playing.
- If you use Ver.11 or later of Windows Media Player, the album art for WMA files can be displayed.
- WMA Lossless files can be played when using a server supporting transcoding, such as Windows Media Player Ver. 11 or later.

NOTE

- When playing back music files with your PC or NAS connected through wireless LAN, audio may be interrupted depending on your wireless LAN environment. In this case, play back music files with your PC or NAS connected through wired LAN.
- Depending on the size of the still picture (JPEG) file, some time may be required for the file to be displayed.
- The order in which the tracks/files are displayed depends on the server specifications. If the tracks/files are not displayed in alphabetical order due to the server specifications, searching by the first letter may not work properly.

Operations available through the OPTION button

Press the **OPTION** button to display a menu of functions that can be used on the TV screen. Select the function you want to use from this menu. You can easily find and use the desired function.

❑ **Searching content with keywords (Text Search)** (👉 [page 64](#))

❑ **Performing repeat playback (Repeat)** (👉 [page 64](#))

❑ **Performing random playback (Random)** (👉 [page 65](#))

❑ **Playing back still images in sequential order (Slideshow Interval)** (👉 [page 67](#))

❑ **Add to favorites from the Option menu (Save to Favorites)** (👉 [page 66](#))

❑ **Playing back music and a favorite picture at the same time (Slideshow)** (👉 [page 67](#))

❑ **Displaying your desired video on the monitor during audio playback (Video Select)** (👉 [page 68](#))

❑ **Adjusting the picture quality for your viewing environment (Picture Mode)** (👉 [page 68](#))

❑ **All Zone Stereo function** (👉 [page 69](#))

❑ Media Server operation buttons



Operation buttons	Function
CH/PAGE ▲▼	Page search
INFO	Display of information such as the source name, volume, and sound mode name
OPTION	Text Search / Repeat playback / Random playback / Slideshow Interval / Save to Favorites / Slideshow / Video Select / Picture Mode / All Zone Stereo
△▽◀▶	Cursor operation / Next/Previous (△▽) / Fast-forward/Fast-reverse (Press and hold, △▽)*
ENTER (Press and release)	Enter
ENTER (Press and hold)	Stop
BACK	Return
SETUP	Setup menu
⏪ ⏩ (Press and release)	Next/Previous
⏪ ⏩ (Press and hold)	Fast-forward/Fast-reverse*
▶/⏸	Playback / Pause
FAVORITE STATION 1 – 3	Add/call up favorite stations
FAVORITE STATION 1 – 3 (Press and hold)	Add to the favorite stations

* This function is available while an MP3 / WAV / AAC / FLAC file is being played back.

Using online services

This unit supports playback of the online services shown below.

❑ About Flickr (👉 page 54)

Flickr is an online photograph sharing service that started in 2004. You can use this unit to view photographs that have been made public by Flickr users. You do not need an account to use Flickr. To view photographs that you recorded yourself, you need an account in order to upload these photographs to the Flickr server. For details, see the Flickr homepage.
<http://www.flickr.com/>

❑ About Pandora® (👉 page 56)

Pandora is an automated music recommendation and Internet Radio service created by the Music Genome Project. To listen to Pandora you will need a free Pandora account. If you do not have a Pandora account, you can create one at www.pandora.com or from the Pandora smartphone application. It is necessary to associate this machine with a Pandora account by visiting <http://www.pandora.com/marantz> from your PC.

❑ About SiriusXM (👉 page 60)

Enjoy anywhere access to the unparalleled content of SiriusXM. Whether on your computer, smartphone, tablet, Lynx Portable Enjoy anywhere access to the unparalleled content of SiriusXM. Whether on your computer, smartphone, tablet, Lynx Portable Radio, or compatible Internet-connected device, you don't need to be in your vehicle to enjoy SiriusXM. For details, see the SiriusXM homepage.
<http://www.siriusxm.com>

❑ About Spotify (👉 page 62)

Introduce your Marantz to a whole new world of music. With Spotify, you can enjoy instant access to millions of songs. A Spotify Premium subscription is required. For details, see the Spotify homepage.
<http://www.spotify.com>

Viewing photographs on the Flickr site

You can view photographs shared by particular users, or all of the photographs shared on Flickr.

Viewing photographs shared by particular users

1 Prepare for playback.

- ① Check the network environment, then turn on this unit's power (☞ [page 20](#) "Connecting to a home network (LAN)").
- ② If settings are required, make the "Settings" (☞ [page 129](#)).

2 Press NETWORK.

3 Use Δ ∇ \triangleleft \triangleright to select "Flickr", then press ENTER.

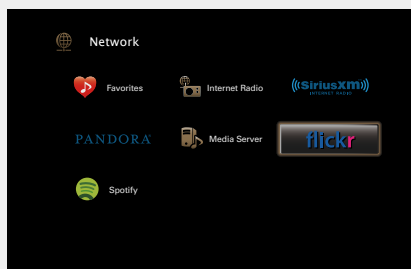

4 Use Δ ∇ to select "Add Flickr Contact", then press ENTER or \triangleright .

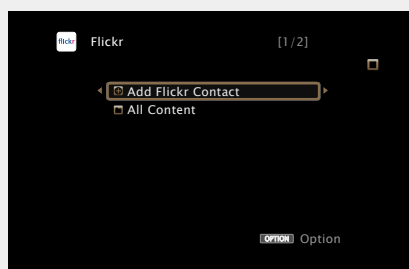

5 In "Contact", add the screen name (user name you want to view) you want to add.

- For character input, see [page 107](#).

6 After inputting the "Contact", press **OK**.

The screen name is added to "Contact", and the screen name you entered in Step 5 is displayed on the top screen of Flickr.

- If you enter a screen name that does not exist, "The Flickr Contact you entered could not be found" is displayed. Check and enter the correct screen name.

7 Use Δ ∇ to select the folder, and then press ENTER or \triangleright .

Favorites	Displays the favorite photographs of the specified user.
Photostream	Displays a list of shared photographs.
PhotoSets	Displays the folder (photograph album) list.
Contacts	Displays the screen name used by the specified user in Contacts.
Remove this Contact	Deletes a user from Flickr Contact.
Add this Contact	Adds a user from Flickr Contact.

8 Use Δ ∇ to select the file, and then press ENTER or \triangleright .

The selected file is displayed.

Going back to the previous screen

Press \triangleleft or **BACK**.

Operations available through the OPTION button

Press the **OPTION** button to display a menu of functions that can be used on the TV screen. Select the function you want to use from this menu. You can easily find and use the desired function.

☐ **Playing back still images in sequential order (Slideshow Interval)** (☞ [page 67](#))

☐ **Displaying your desired video on the monitor during audio playback (Video Select)** (☞ [page 68](#))

☐ **Adjusting the picture quality for your viewing environment (Picture Mode)** (☞ [page 68](#))

☐ **All Zone Stereo function** (☞ [page 69](#))

❑ Viewing all photographs on Flickr

1 Use Δ / ∇ to select “All Content”, then press **ENTER** or \triangleright .

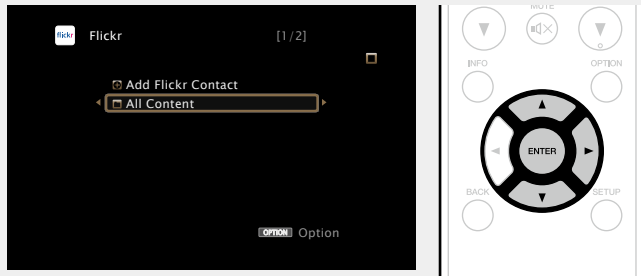

2 Use Δ / ∇ to select the folder, and then press **ENTER** or \triangleright .

Interestingness Displays photographs that are popular from the number of user comments or number of times they are added as favorites.

Recent Displays the most recently added photographs.

Search by text Search for photographs by keyword.

3 Use Δ / ∇ to select the file, and then press **ENTER** or \triangleright .
The selected file is displayed.

NOTE

Depending on the file format, some photographs may not be viewable.

❑ Flickr operation buttons

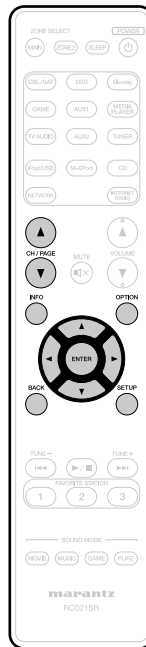

Operation buttons	Function
CH/PAGE Δ / ∇	Page search
INFO	Display of information such as the source name, volume, and sound mode name
OPTION	Video Select / Picture Mode / All Zone Stereo
Δ / ∇ / \triangleleft / \triangleright	Cursor operation / Next/Previous (Δ / ∇)
ENTER (Press and release)	Enter
ENTER (Press and hold)	Stop
BACK	Return
SETUP	Setup menu

Listening to Pandora®

1 Prepare for playback.

- ① Check the network environment, then turn on this unit's power (see [page 20](#) "Connecting to a home network (LAN)").
- ② If settings are required, make the "Settings" (see [page 129](#)).
- ③ Complete step 4 and obtain a Pandora account.
 - If you already have a Pandora account, you do not need to obtain a new account. Use your existing Pandora account.

2 Press NETWORK.

3 Use $\Delta \nabla \triangleleft \triangleright$ to select "Pandora", then press ENTER.

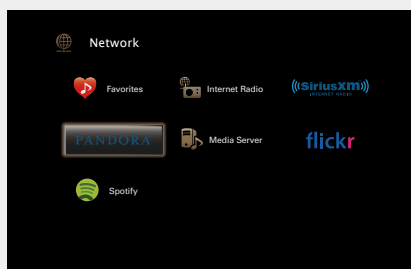

4 If you have a Pandora account, use $\Delta \nabla$ to select "I have a Pandora account", then press ENTER or \triangleright .

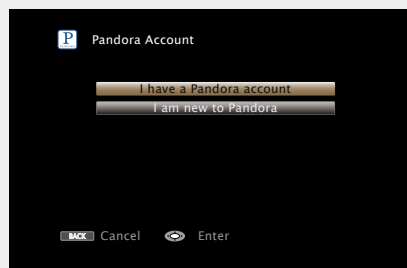

- If you do not have a Pandora account, press ∇ to select "I am new to Pandora". The URL of Pandora and activation code are displayed. Access the Pandora web page from your PC and register the displayed activation code and account information. Then press **ENTER**.

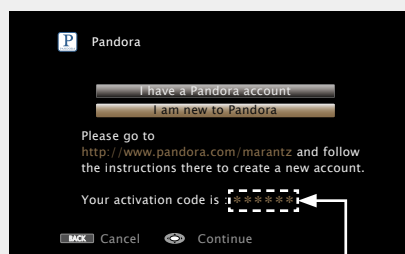

This is an identification code required to register your purchased product to the Pandora service.
This code is used to obtain your account.

5 Input "Email address" and "Password".

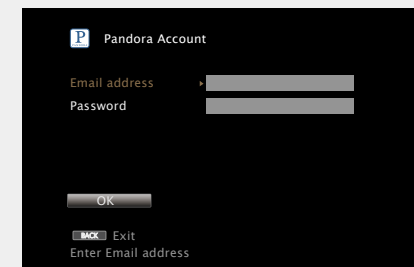

- For character input, see [page 107](#).

6 After inputting the "Email address" and "Password", select "OK", then press ENTER.

If the "Email address" and "Password" match, the top menu for Pandora is displayed.

NOTE

Press **BACK** to cancel the input. When "Cancel Input?" is displayed, select "Yes", then press **ENTER**.

Operations available through the OPTION button

Press the **OPTION** button to display a menu of functions that can be used on the TV screen. Select the function you want to use from this menu. You can easily find and use the desired function.

❑ **Displaying your desired video on the monitor during audio playback (Video Select)** (👉 [page 68](#))

❑ **Adjusting the picture quality for your viewing environment (Picture Mode)** (👉 [page 68](#))

❑ **All Zone Stereo function** (👉 [page 69](#))

❑ Creating a new station

You can create up to 100 radio stations.

1 Use Δ / ∇ to select “New Station”, then press **ENTER** or \triangleright .

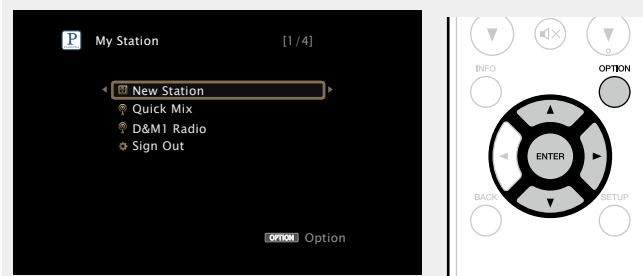

2 Input a track or artist name, then press **OK**.



• For character input, see [page 107](#).

3 Use Δ / ∇ to select “Search by Artist” or “Search by Track”, then press **ENTER**.

You can search and display a list by track or artist.



4 Press Δ / ∇ , select a file (e.g. D&M2) from the list, and press **ENTER** or \triangleright .

“Radio” is added to the end of a filename, and your new station is created (e.g. D&M2 Radio).

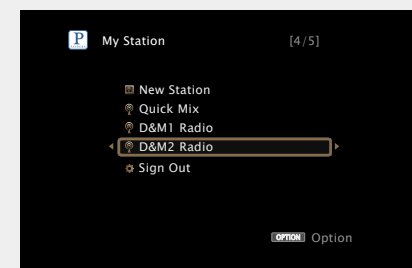

• Your new station will play music with similar qualities to the artist or track you entered.

Listening to an existing station

Use Δ / ∇ and select the radio station (“D&M2 Radio”) that you want to listen to, and press ENTER or \triangleright .

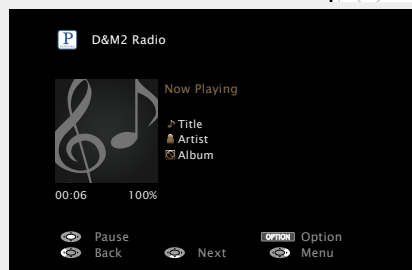
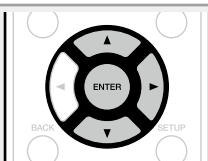

Listening to created radio stations at random

Use Δ / ∇ to select “Quick Mix”, then press ENTER or \triangleright .

Created radio stations are selected at random, and tracks are streamed.

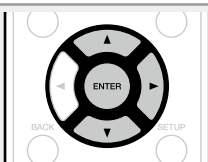

Giving Feedback and Managing Stations

You can personalize your stations by providing feedback.

Press \triangleright while a track is playing.

The Pandora menu screen is displayed.

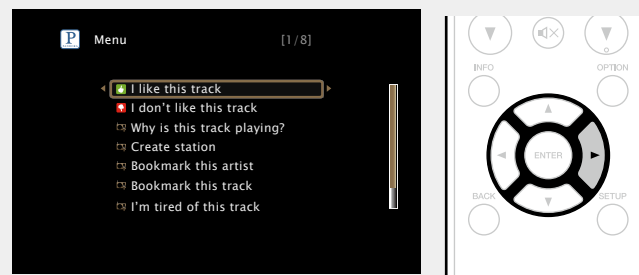

- | | |
|-----------------------------------|--|
| I like this track | <ul style="list-style-type: none"> • Press when you like the track that is being played. • It will return to the Play Screen. And (Thumbs up) icon is displayed. (The icon is not displayed on the next track.) |
| I don't like this track | <ul style="list-style-type: none"> • Press when you don't like the track that is being played. • It will return to the Play Screen. And (Thumbs down) icon is displayed. (The icon is not displayed on the next track.) |
| Why is this track playing? | <ul style="list-style-type: none"> • Displays the reason why Pandora selected this track. |
| Create station | <ul style="list-style-type: none"> • Creates a Station for the Track or Artist being played. |
| Bookmark this artist | <ul style="list-style-type: none"> • Bookmarks the artist currently being played. • You can check on a computer or iPhone etc. • For details, see the Pandora web page. |
| Bookmark this track | <ul style="list-style-type: none"> • Bookmarks the track currently being played. • You can check on a computer or iPhone etc. • For details, see the Pandora web page. |
| I'm tired of this track | <ul style="list-style-type: none"> • Press when you don't like the track that is being played. • The track will not be played for 1 month. |
| Delete this station | <ul style="list-style-type: none"> • Press when you want to delete the station that is being played. |

NOTE

- You can Skip up to 6 Tracks that are being played back within 1 hour.
- You can create up to 100 Stations (radio stations).

Sign out

Disassociate this unit from your Pandora account.

1 Use Δ / ∇ to select “Sign Out”, then press ENTER or \triangleright .

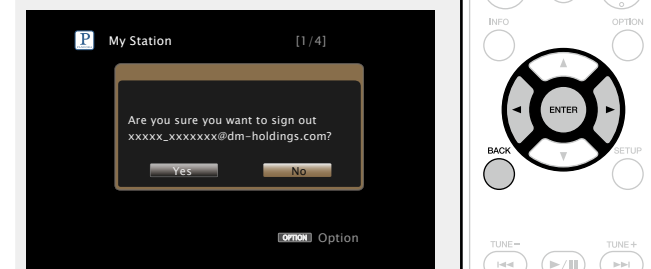

2 When the popup menu appears, use \triangleleft / \triangleright to select “Yes”, then press ENTER.

□ Pandora operation buttons

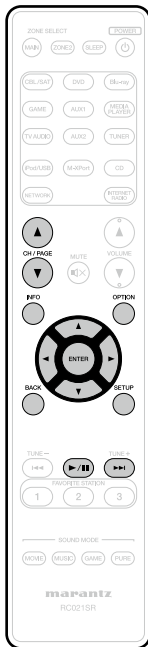

Operation buttons	Function
CH/PAGE ▲▼	Page search
INFO	Display of information such as the source name, volume, and sound mode name
OPTION	Video Select / Picture Mode / All Zone Stereo
△▽◀▶	Cursor operation / Skips the current track, subject to skip limit (▽)
ENTER (Press and release)	Enter
ENTER (Press and hold)	Stop
BACK	Return
SETUP	Setup menu
▶/	Playback / Pause
▶▶	Skips the current track, subject to skip limit

Listening to SiriusXM Internet Radio

Over 120 channels of the SiriusXM programming you love, including commercial-free music plus sports, talk, news and entertainment. Listen anywhere on your computer or smartphone.

1 Prepare for playback.

- ① Check the network environment, then turn on this unit's power (☞ [page 20](#) "Connecting to a home network (LAN)").
- ② If settings are required, make the "Settings" (☞ [page 129](#)).
- ③ Access the following website from your PC and obtain a SiriusXM account.
<http://www.siriusxm.com>
 - If you already have a SiriusXM account, you do not need to obtain a new account. Select "Sign in" in step 4, and enter your existing SiriusXM account.

2 Press NETWORK.

3 Use Δ ∇ \triangleleft \triangleright to select "SiriusXM", then press ENTER.

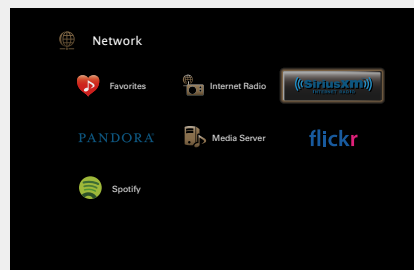

4 Select "Sign in", then press ENTER.

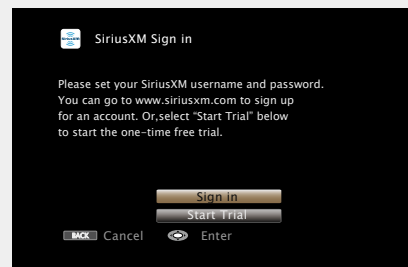

5 Input the "Username" and "Password".

- For character input, see [page 107](#).

6 Select the "Sign in", and then press ENTER.

The top menu of SiriusXM is displayed.



7 Use Δ ∇ to select the genre, then press ENTER or \triangleright .

8 Use Δ ∇ to select the file, and then press ENTER or \triangleright .

The selected file is displayed.

☐ Going back to the previous screen

Press \triangleleft or BACK.

Operations available through the OPTION button

Press the **OPTION** button to display a menu of functions that can be used on the TV screen. Select the function you want to use from this menu. You can easily find and use the desired function.

☐ **Displaying your desired video on the monitor during audio playback (Video Select)** (☞ [page 68](#))

☐ **Adjusting the picture quality for your viewing environment (Picture Mode)** (☞ [page 68](#))

☐ **All Zone Stereo function** (☞ [page 69](#))

❑ Sign out

Disassociate this unit from your SiriusXM account.

1 Use Δ / ∇ to select “Sign Out”, then press **ENTER** or \triangleright .

2 When the popup menu appears, use \triangleleft / \triangleright to select “Yes”, then press **ENTER**.

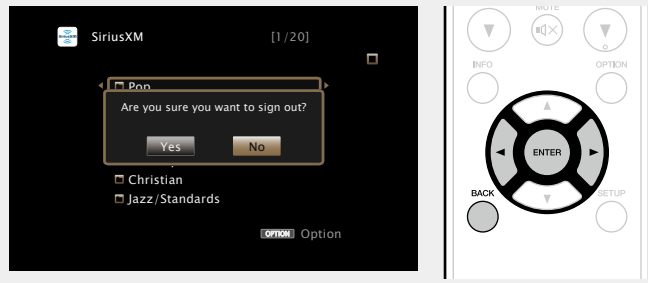

❑ SiriusXM operation buttons

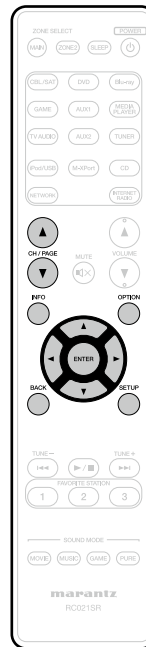

Operation buttons	Function
CH/PAGE \blacktriangle / \blacktriangledown	Page search
INFO	Display of information such as the source name, volume, and sound mode name
OPTION	Video Select / Picture Mode / All Zone Stereo
\triangleleft / \triangleright / \triangle / ∇	Cursor operation
ENTER (Press and release)	Enter
ENTER (Press and hold)	Stop
BACK	Return
SETUP	Setup menu

Listening to Spotify

Introduce your Marantz to a whole new world of music. With Spotify, you can enjoy instant access to millions of songs.

A Spotify Premium subscription is required.

For details, see the Spotify homepage.

<http://www.spotify.com>

1 Prepare for playback.

- Check the network environment, then turn on this unit's power (refer to [page 20](#) "Connecting to a home network (LAN)").
- If settings are required, make the "Settings" (refer to [page 129](#)).
- Complete step 5 and obtain a Spotify account.
 - If you already have a Spotify account, you do not need to obtain a new account. Use your existing Spotify account.

2 Press NETWORK.

3 Use $\Delta \nabla \triangleleft \triangleright$ to select "Spotify", then press ENTER.

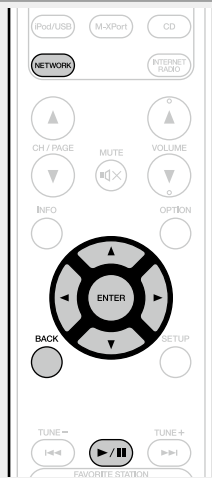
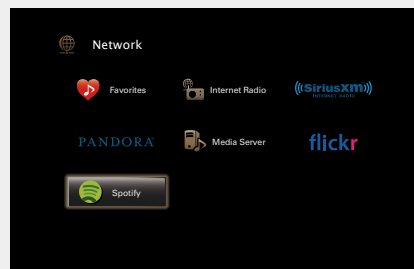

4 If you have a Spotify account, then press ENTER.

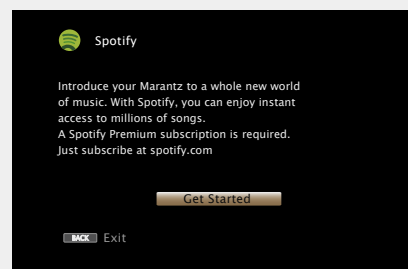

5 Use $\Delta \nabla \triangleright$ to enter your username and password.

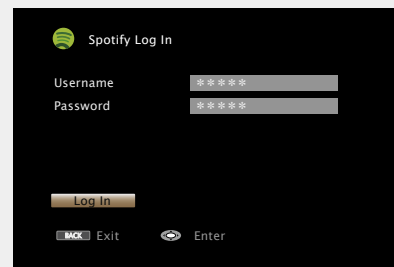

- The password should be no longer than 99 characters. For character input, see [page 107](#).
- The types of characters that can be input are as shown below.

[Upper case characters/Numbers/Symbols]
 ABCDEFGHIJKLMNOPQRSTUVWXYZ
 ÅÄÅÄÅÄÆÇÐÈÉÊËÌÍÎÏÑÒÓÔÕÖØÙÚÛÜÝ
 0123456789
 ! " # \$ % & ' () * + , ; < = >

[Lower case characters/Numbers/Symbols]
 abcdefghijklmnopqrstuvwxyz
 åäååååæçðèéêëìíîïñòóôõöøùúûýþÿ
 0123456789
 . @ - _ / : ~ ? [\] ^ ' { | }

- When you use $\Delta \nabla$ while you type in, you can change uppercase characters to lowercase and vice versa.
- Press **BACK** to cancel the input. When "Cancel input?" is displayed, select "Yes", then press **ENTER**.

6 After inputting the username and password, select "Log In", then press ENTER.

If the username and password match, the top menu for Spotify is displayed.

7 Use $\Delta \nabla$ to select menu and then press ENTER.

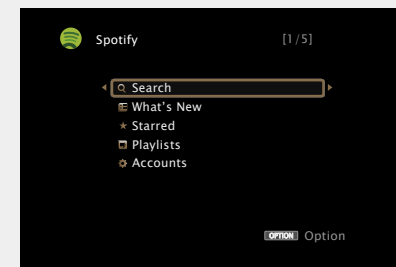

Search Searches for tracks, artists and albums by entering keywords.

What's New Displays the list of the latest albums.

Starred Displays the list of the starred tracks.

Playlists Displays the playlists for Spotify.

Accounts Manages accounts (Log out, Add new user, Switch to user).

8 Use $\Delta \nabla$ to select a station, and press ENTER or $\blacktriangleright / \parallel$ to start playback.

Playback starts and the following screen appears.

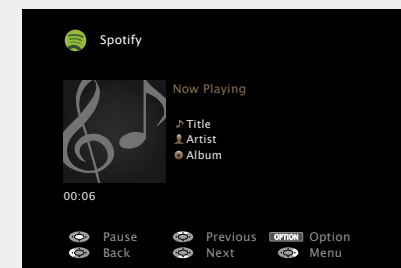

9 Press **▷** while a track is playing.

The Spotify menu screen is displayed.

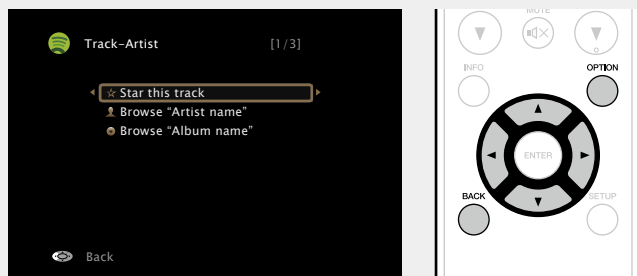

Star this track Adds a star to the selected track.

Browse "Artist name" Displays the list of albums by the artist of the track that is being played back.

Browse "Album name" Displays the list of tracks on the album that is being played back.

❑ **Adjusting the sound quality (M-DAX)**

Make this setting at "M-DAX" ([page 111](#)) in the menu.

You can use the M-DAX function to improve the fidelity of compressed audio sources such as content from streaming music services. The M-DAX has selectable levels of restoration. The default setting is "Off".

❑ **Switching the screen display**

Press **STATUS** on the main unit.

The display switches between track title, artist name, and album title each time the button is pressed.

❑ **Going back to the previous screen**

Press **◀** or **BACK**.

❑ **Changing the screen display duration**

Make this setting at "Now Playing" ([page 118](#)) in the menu. The default setting is "Always On".

When "Auto Off" is set, the on-screen display is turned off 30 seconds after an operation.

Press **△▽◀▷** while the display is off to return to the original screen.

Operations available through the **OPTION** button

Press the **OPTION** button to display a menu of functions that can be used on the TV screen. Select the function you want to use from this menu. You can easily find and use the desired function.

❑ **Performing repeat playback (Repeat)**

([page 64](#))

❑ **Performing random playback (Random)**

([page 65](#))

❑ **Displaying your desired video on the monitor during audio playback (Video Select)**

([page 68](#))

❑ **Adjusting the picture quality for your viewing environment (Picture Mode)**

([page 68](#))

❑ **All Zone Stereo function**

([page 69](#))

❑ **Spotify operation buttons**



Operation buttons	Function
CH/PAGE ▲▼	Page search
INFO	Display of information such as the source name, volume, and sound mode name
OPTION	Repeat playback / Random playback / Video Select / Picture Mode / All Zone Stereo
△▽◀▷	Cursor operation / Next/Previous (△▽) / Fast-forward/Fast-reverse (Press and hold, △▽)
ENTER (Press and release)	Enter
ENTER (Press and hold)	Stop
BACK	Return
SETUP	Setup menu
⏮ ⏭ (Press and release)	Next/Previous
⏮ ⏭ (Press and hold)	Fast-forward/Fast-reverse
▶⏸	Playback / Pause

Convenient functions

Here, we explain how to use convenient functions for NETWORK sources and USB sources. The source names under the titles of each function's description are sources that allow use of these functions.

❑ **Searching content with keywords (Text Search)** (👉 [page 64](#))

❑ **Performing repeat playback (Repeat)** (👉 [page 65](#))

❑ **Performing random playback (Random)** (👉 [page 65](#))

❑ **Favorites function** (👉 [page 66](#))

❑ **Playing back music and a favorite picture at the same time (Slideshow)** (👉 [page 67](#))

❑ **Playing back still images in sequential order (Slideshow Interval)** (👉 [page 67](#))

❑ **Adjusting the picture quality for your viewing environment (Picture Mode)** (👉 [page 68](#))

❑ **All Zone Stereo function** (👉 [page 69](#))

Searching content with keywords (Text Search)

USB Internet Radio Media Server

1 While content is playing, press **OPTION**.
The option menu screen is displayed.

2 Use Δ / ∇ to select "Text Search", then press **ENTER**.
The keyboard input screen is displayed.

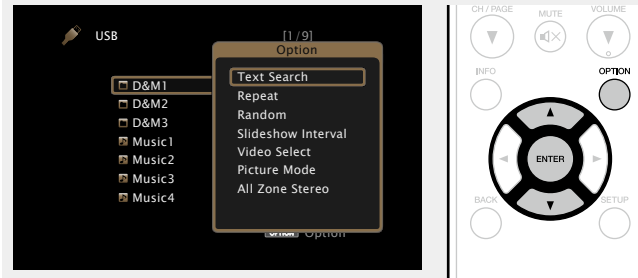

3 Enter the first character of the Internet Radio station or file you want to search for, and then press **OK**.

• For character input, see [page 107](#).



"Text Search" searches for Internet Radio stations or files that start with the entered first character from the displayed list.

NOTE

"Text Search" may not work for some lists.

❑ Playing back a search result content

Use Δ / ∇ to select the content you want to play, and then press **ENTER** or \triangleright .

Playback starts.

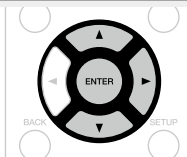

Performing repeat playback (Repeat)

USB Media Server Spotify

1 While content is playing, press **OPTION**.
The option menu screen is displayed.

2 Use Δ / ∇ to select "Repeat", then press **ENTER**.

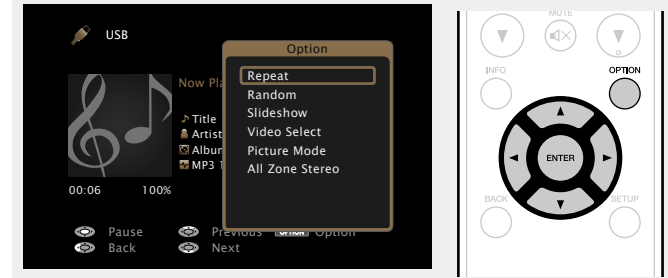

3 Use \triangleleft / \triangleright to select repeat playback mode.

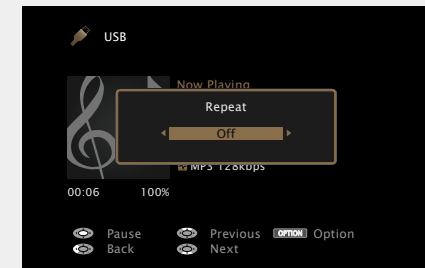

• Each time \triangleleft / \triangleright is pressed, the setting is changed as shown below.



Off Repeat playback mode is canceled.

One A file being played is played repeatedly.

All All files in the folder currently being played are played repeatedly.

4 Press **ENTER**.
The display returns to the playback screen.

Performing random playback (Random)

USB **Media Server** **Spotify**

1 While content is playing, press **OPTION**.
The option menu screen is displayed.

2 Use Δ / ∇ to select “Random”, then press **ENTER**.



3 Use \triangleleft / \triangleright to select random playback mode.

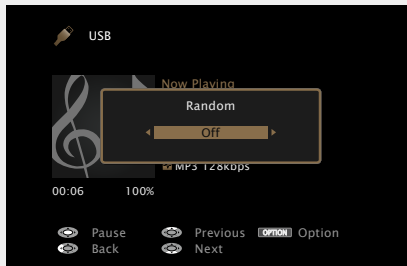

• Each time \triangleleft / \triangleright is pressed, the setting is changed as shown below.

Off \longleftrightarrow On

Off Disable random playback.

On Randomly play back all tracks in the current playback folder.

4 Press **ENTER**.
The display returns to the playback screen.



During random playback, each time playback of a track is completed, another track is randomly selected for playback from tracks in the folder. Therefore, it's possible that you may hear a track played back more than once during random playback.

Favorites function

There are two ways to add content to favorites:

- ① Add to favorites from the Option menu
- ② Add to the **FAVORITE STATION** button

❑ Add to favorites from the Option menu (Save to Favorites)

Internet Radio **Media Server**

You can add up to 100 items as favorites for all sources (Internet Radio and Media Server).

1 While content is playing, press **OPTION**.

The option menu screen is displayed.

2 Use $\Delta \nabla$ to select “Save to Favorites”, then press **ENTER**.

“Favorite added” is displayed, and the current content is added to favorites.

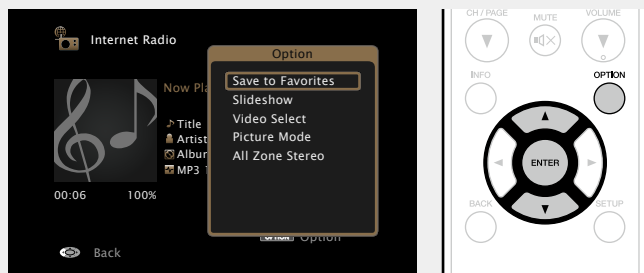

- The display returns to the playback screen when the procedure is completed.

Playing back content added in “Save to Favorites”

1 Press **NETWORK**.

2 Use $\Delta \nabla \leftarrow \rightarrow$ to select “Favorites”, then press **ENTER**.

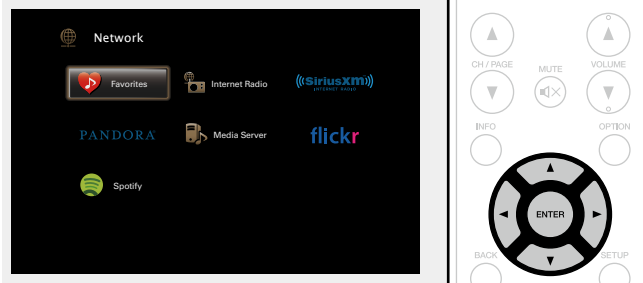

3 Use $\Delta \nabla$ to select the content you want to play, and then press **ENTER** or \rightarrow . Playback starts.

❑ Adding to the **FAVORITE STATION** button

You can add up to three types of content.

NOTE

- Please note that if you add new content to a number that already contains content, the older content is deleted.
- The following operations update the database on the Media Server, which may make the added music files unplayable.
 - When you quit the Media Server and then restart it.
 - When music files are deleted or added on the Media Server.
- When using an ESCIENT server, place “ESCIENT” before the server name.

Press and hold one of the **FAVORITE STATION 1 – 3** buttons for 3 seconds or longer while playing back a content or listening to a radio station.

The content you are playing back or the radio station you are listening to is registered to the pressed button.

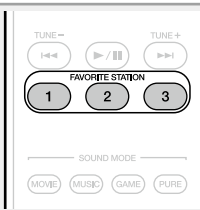

Contents that can be added to the **FAVORITE STATION** button differ depending on the input source.

Input source	Contents that can be added
TUNER	Radio station
Internet Radio	Top list of content / Internet Radio station
Media Server	Top list of content / Track
Flickr	Top list of content
Pandora	Top list of content
SiriusXM	Top list of content
Spotify	Top list of content
Favorites	Top list of content / Internet Radio station / Track of Media Server

Playing back content added to the **FAVORITE STATION** button

You can easily call up content by pressing the **FAVORITE STATION** button.

Press one of the **FAVORITE STATION 1 – 3** buttons that you added content to.

Playback starts.

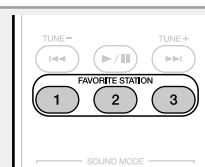

Internet Radio stations are already registered to the **FAVORITE STATION 1 – 3** buttons. However, you may not be able to play the stations due to restrictions imposed by the radio stations.

Deleting content added to favorites (Remove from Favorites)

1 Press **NETWORK**.

2 Use $\Delta \nabla \triangleleft \triangleright$ to select **“Favorites”**, then press **ENTER**.

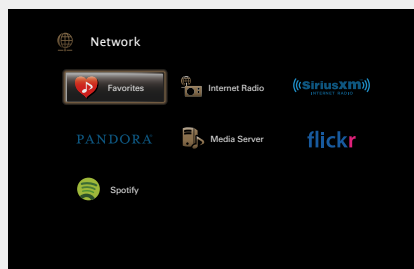

3 Use $\Delta \nabla$ to select the content you want to delete from favorites, then press **OPTION**.

The option menu screen is displayed.

4 Use $\Delta \nabla$ to select **“Remove from Favorites”**, then press **ENTER**.

“Favorite removed” is displayed, and the selected content is deleted from favorites.

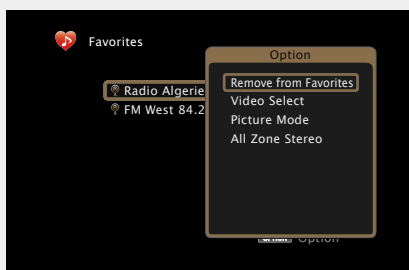

• The display returns to the original screen when the procedure is completed.

Playing back music and a favorite picture at the same time (Slideshow)

USB **Internet Radio** **Media Server**

1 Play back a still picture.

- Playing back still pictures stored on USB memory devices (page 35).
- Playing back still pictures stored on Flickr (page 54).

2 Play back a music file or Internet Radio station (page 46, 51).

3 Press **OPTION**.

The option menu screen is displayed.

4 Use $\Delta \nabla$ to select **“Slideshow”**, then press **ENTER**.

The option menu disappears, and the picture you were viewing is shown on the screen.

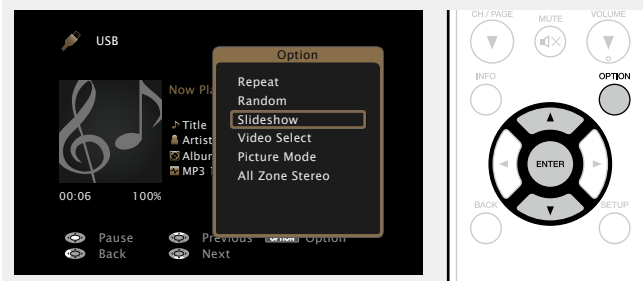

Playing back still images in sequential order (Slideshow Interval)

You can play back still image (JPEG) files stored on a USB memory device or Media Server and pictures on Flickr website as a slide show. The display time can also be set.

USB **Media Server** **Flickr**

1 Play back an image and press **OPTION**.

The option menu screen is displayed.

2 Use $\Delta \nabla$ to select **“Slideshow Interval”**, then press **ENTER**.

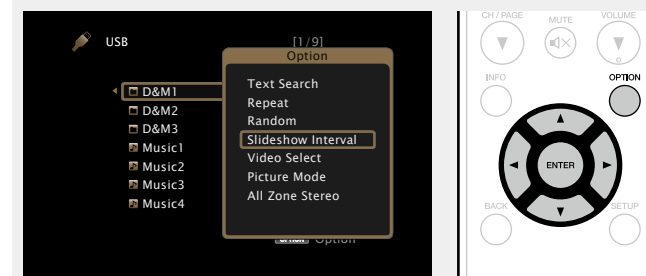

3 Use $\triangleleft \triangleright$ to set the display time.

- Each time $\triangleleft \triangleright$ is pressed, the setting is changed as shown below.

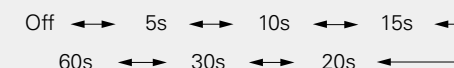

Off The slide show is not played back.

5s – 60s Set the time for displaying a single image when playing back images in the slide show.

4 Press **ENTER**.

The slide show is displayed on the screen.



This unit plays back image (JPEG) files in the orientation in which they are stored in the folder.

Displaying your desired video on the monitor during audio playback (Video Select)

This unit can display video from a different source on TV during audio playback.

You can set this for each input source.

USB **CD** * **TUNER** **NETWORK**

* Available when none of HDMI, component video or video connector is assigned.

1 Press **OPTION** during audio playback.

The option menu screen is displayed.

2 Use $\Delta \nabla$ to select "Video Select", then press **ENTER**.

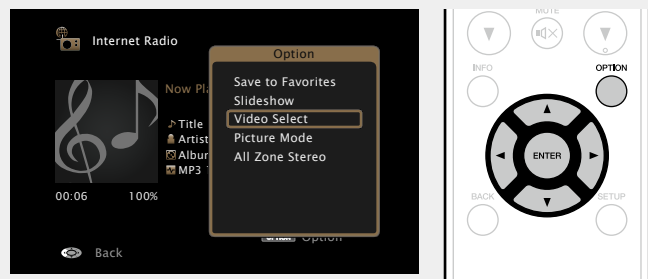

3 Use $\triangleleft \triangleright$ to select the Video Select mode.

• Each time $\triangleleft \triangleright$ is pressed, the setting is changed as shown below.

Off \longleftrightarrow On

Off Disable Video Select mode.

On Enable Video Select mode.

4 If you selected "On" in step 3, press ∇ and select "Source".

5 Press $\triangleleft \triangleright$ to select the input source for video you want to play back, and press **ENTER**.

Playback starts.

NOTE

Input sources for which "Hide" is selected at "Hide Sources" (page 122) cannot be selected.

Adjusting the picture quality for your viewing environment (Picture Mode)

CBL/SAT **DVD** **Blu-ray** **GAME** **AUX1** **AUX2** **MEDIA PLAYER**
USB **Internet Radio** **Media Server** **CD** * **TV AUDIO** *

* You can set the picture mode when an HDMI, component video or video connector is assigned.

1 While content is playing, press **OPTION**.

The option menu screen is displayed.

2 Use $\Delta \nabla$ to select "Picture Mode", then press **ENTER**.

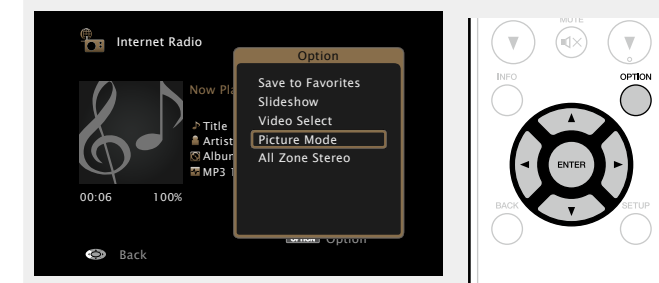

3 Use ◀▶ to select picture mode.

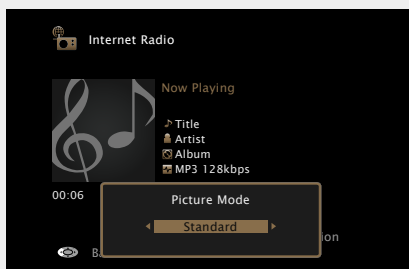

• Each time ◀▶ is pressed, the setting is changed as shown below.

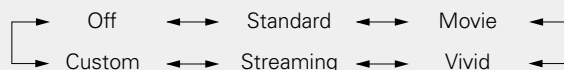

- Off** No picture quality adjustment is done with this unit.
- Standard** The standard mode suited for most living room viewing environments.
- Movie** A mode suited for watching movies in a dark room such as a theater room.
- Vivid** A mode that makes graphic images for games, etc. brighter and more vivid.
- Streaming** A mode suited for low bit rate video sources.
- Custom** Adjusts the picture quality manually.

4 Press ENTER.

The display returns to the playback screen.

All Zone Stereo function

You can play back music in multi-zones (ZONE2) simultaneously that is played back in MAIN ZONE.

It is useful when you want to enjoy the same music at the same time in multiple rooms during home party or when you want to play back the same BGM in the entire house.

The All Zone Stereo function can be set for any source.



Before setting this function, you need to turn on the multi-zones (ZONE2) for which you want to use the All Zone Stereo function.

1 Press MAIN to switch the zone mode.

MAIN lights.

2 Press OPTION.

The option menu screen is displayed.

3 Use ▲▼ to select “All Zone Stereo”, then press ENTER.

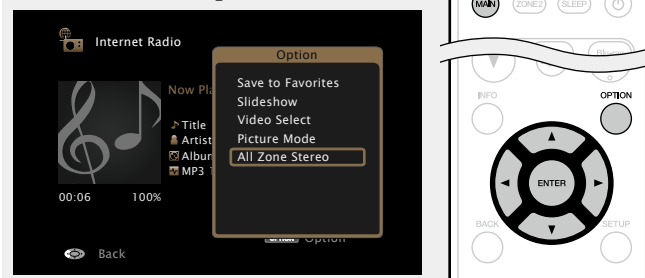

4 Use ◀▶ to select “On”, then press ENTER.

The input source for the multi-zones (ZONE2) is switched to the same as the one for MAIN ZONE, and playback in the All Zone Stereo mode starts.

Stopping the All Zone Stereo function

1 During playback in All Zone Stereo, press OPTION.

The option menu screen is displayed.

2 Use ▲▼ to select “All Zone Stereo”, then press ENTER.

3 Use ◀▶ to select “Off”, then press ENTER.

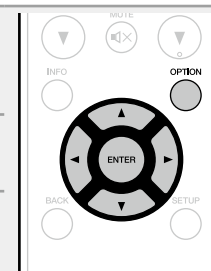

The All Zone Stereo function is also stopped when you:

- Turn MAIN ZONE off.
- Change the input source for MAIN ZONE.
- Change the sound mode.

NOTE

When “HDMI Audio Out” (page 115) is set to “TV”, the All Zone Stereo function is not available.

AirPlay function

Enjoy music from your iTunes library with high quality sound anywhere in your home.

Use the Apple Remote App* for iPhone, iPod touch and iPad to control iTunes from any room in your home.

* Available as a free download from the App Store.

Streaming music stored in iPhone, iPod touch, or iPad directly to the unit

If you update your "iPhone/iPod touch/iPad" to iOS 4.2.1 or later, you can stream music stored in your "iPhone/iPod touch/iPad" directly to this unit.

1 Make the Wi-Fi settings for iPhone, iPod touch, or iPad.

• For details, see your device's manual.

2 Startup iPhone, iPod touch, or iPad music or iPod app.

 is displayed on the iPhone, iPod touch or iPad screen.

3 Tap the AirPlay icon .

4 Select the speaker you want to use.

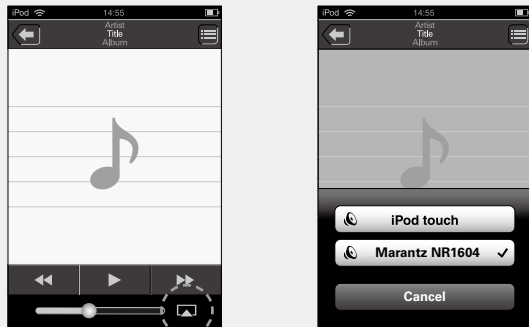

NOTE

In playback using the AirPlay function, the sound is output at the iPhone, iPod touch, iPad or iTunes volume setting level.

You should turn down the iPhone, iPod touch, iPad or iTunes volume prior to playback and then adjust it to a suitable level.

Playing iTunes music with this unit

1 Install iTunes 10, or later, on a Mac or Windows PC that is connected to the same network as this unit.

2 Turn this unit ON.

Set "IP Control" ([see page 128](#)) to "Always On" for this unit.

NOTE

When "IP Control" is set to "Always On", the unit consumes more standby power.

3 Launch iTunes and click the AirPlay icon displayed the window and select this unit from the list.



4 Choose a song and click play in iTunes.

The music will stream to this unit.

Selecting multiple speakers (devices)

It is possible to play iTunes songs on your home's AirPlay compatible speakers (devices) other than those of this unit.

1 Click the AirPlay icon and select "Multiple".

2 Check the speakers you want to use.

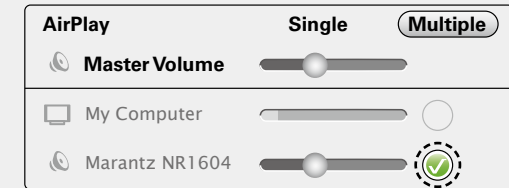

□ Perform iTunes playback operations with the remote control unit of this unit

With this unit's remote control unit, you can perform iTunes song play, pause, and auto search (cue) operations.

1 Select “Edit” – “Preferences...” on the menu.

2 Select “Devices” in the iTunes setting window.

3 Check “Allow iTunes audio control from remote speakers”, and then click “OK”.

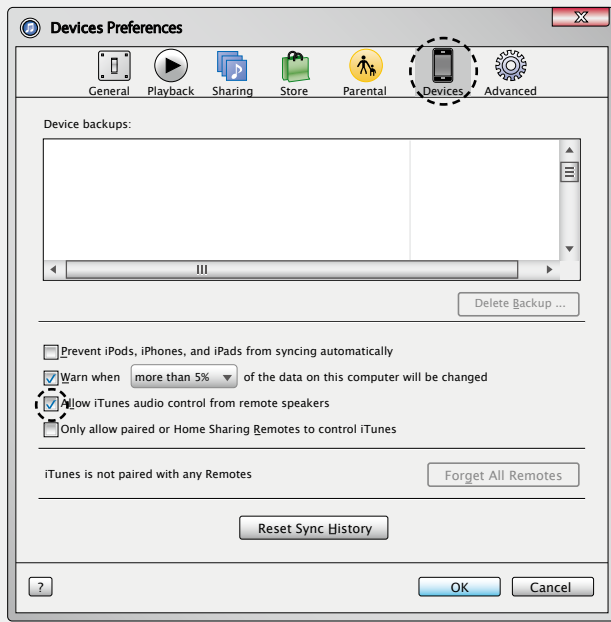

-  is displayed on the menu screen while AirPlay is being operated.
- Source input will be switched to “NETWORK” when AirPlay playback is started.
- You can stop AirPlay playback by pressing the ◀ or choosing other input source.
- To see song and artist names together, press **STATUS** on the main unit.
- For information about how to use iTunes, also see the Help for iTunes.
- The screen may differ depending on the OS and software versions.

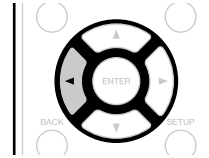

Selecting a listening mode (Sound Mode)

This unit allows you to enjoy various kinds of surround and stereo playback modes.

Multi-channel audio formats are provided on popular movie and music disc formats such as Blu-ray and DVD, as well as being supported by digital broadcasting, and even by streaming movies and music from internet-based subscription services.

This unit supports playback of almost all of these multi-channel audio formats. It also supports surround playback of audio formats other than multi-channel audio such as 2-channel stereo audio.

This unit automatically generates a list of all the playable sound modes based on the input audio format and the current speaker setup configuration and displays the list on the screen. Therefore, you can select a correct surround playback mode even if you are not familiar with sound mode selection. Try out various surround playback modes and enjoy surround playback in your favorite mode.

[Example] When **MOVIE** is pressed and held



The displayed sound modes include the 2-channel stereo playback mode with no additional surround sound synthesis.



For audio formats recorded on a disc, see the disc jacket or label.

Selecting a listening mode

1 Play the selected device (page 30 – 62).

2 Press and hold **MOVIE**, **MUSIC** or **GAME** to select a listening mode.

This unit automatically generates and displays a list of selectable sound modes.

- Each time **MOVIE**, **MUSIC** or **GAME** is pressed, the listening mode is switched.

MOVIE Switches to the listening mode suitable for enjoying movies and TV programs.

MUSIC Switches to the listening mode suitable for enjoying music.

GAME Switches to the listening mode suitable for enjoying games.



- Pressing **MOVIE**, **MUSIC** or **GAME** displays a list of the listening modes that can be selected. Each time you press **MOVIE**, **MUSIC** or **GAME**, the listening mode changes.
- While the list is displayed, you can also use Δ / ∇ to select a listening mode.



- The **MOVIE**, **MUSIC**, or **GAME** button memorizes the last sound mode selected for its button. Pressing **MOVIE**, **MUSIC**, or **GAME** recalls the same sound mode as the one selected at the previous playback.
- If the content played back does not support the previously selected sound mode, the most appropriate sound mode for the content is automatically selected.
- This can also be set by pressing **SOUND MODE** on the main unit.

Direct playback

Sound recorded in source is played as is.

1 Play the selected device (page 30 – 62).

2 Press **PURE** to select “DIRECT”.

Direct playback begins.

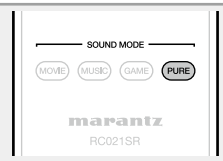

Pure Direct playback

This mode is for playback with higher sound quality than in “DIRECT” mode, by turning off the front panel display panel, which can eliminate faint low level noise from creeping into sensitive analog circuitry.

1 Play the selected device
([page 30](#) – [62](#)).

2 Press **PURE** to select “**PURE DIRECT**”.

PURE DIRECT indicator on the main unit lights.
The display goes dark, and pure direct playback begins.



- In DIRECT and PURE DIRECT listening modes, the following items cannot be adjusted.
 - Tone ([page 111](#))
 - M-DAX ([page 111](#))
 - MultEQ® ([page 112](#))
 - Dynamic EQ ([page 113](#))
 - Dynamic Volume ([page 113](#))
- This can also be set by pressing **PURE DIRECT** on the main unit.

NOTE

- Video signals are only output when HDMI signals are played in the PURE DIRECT mode.
- When in the PURE DIRECT mode, the menu screen is not displayed.
- When in the PURE DIRECT mode, the display turns off and appears as if there is no electricity.

Auto surround playback

This mode detects the type of input digital signal, and automatically selects the corresponding mode for playback.

1 Play the selected device
([page 30](#) – [62](#)).

2 Press **PURE** to select “**AUTO**”.
Auto surround playback begins.

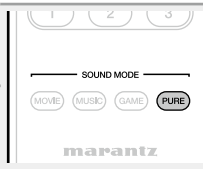

Listening mode

- The following listening modes can be selected using the **MOVIE**, **MUSIC**, **GAME**, and **PURE** buttons.
- Adjust the sound field effect with the menu "Surround Parameter" (page 109) to enjoy surround sound the way you like it.

Operation button	Input signal	Listening mode
MOVIE	2-channel *1	STEREO
		AUTO *2
		DOLBY PLIIx Movie *3
		DOLBY PLII Movie *3
		DOLBY PLIIz Height *3
		DTS NEO:6 Cinema *3
		MULTI CH STEREO
	Multi-channel *4	STEREO
		AUTO *2
	Dolby Digital	DOLBY DIGITAL
		DOLBY DIGITAL EX
		DOLBY DIGITAL + PLIIx Movie
		DOLBY DIGITAL + PLIIz
	Dolby TrueHD	DOLBY TrueHD
		DOLBY TrueHD + EX
		DOLBY TrueHD + PLIIx Movie
		DOLBY TrueHD + PLIIz
	Dolby Digital Plus	DOLBY DIGITAL Plus
		DOLBY DIGITAL Plus + EX
		DOLBY DIGITAL Plus + PLIIx Movie
		DOLBY DIGITAL Plus + PLIIz
	DTS	DTS SURROUND
		DTS ES DSCRT 6.1
		DTS ES MTRX 6.1
DTS 96/24		
DTS + PLIIx Movie		
DTS + PLIIz		
DTS-HD / DTS Express	DTS-HD HI RES	
	DTS-HD MSTR	
	DTS Express	
	DTS-HD + PLIIx Movie	
	DTS-HD + PLIIz	
PCM multi-channel	MULTI CH IN	
	MULTI CH IN 7.1	
	MULTI IN + Dolby EX	
	MULTI IN + PLIIx Movie	
	MULTI IN + PLIIz	
	MULTI CH STEREO	
	VIRTUAL	

Operation button	Input signal	Listening mode
MUSIC	2-channel *1	STEREO
		AUTO *2
		DOLBY PLIIx Music *3
		DOLBY PLII Music *3
		DOLBY PLIIz Height *3
		DTS NEO:6 Music *3
		MULTI CH STEREO
	Multi-channel *4	STEREO
		AUTO *2
	Dolby Digital	DOLBY DIGITAL
		DOLBY DIGITAL EX
		DOLBY DIGITAL + PLIIx Music
		DOLBY DIGITAL + PLIIz
	Dolby TrueHD	DOLBY TrueHD
		DOLBY TrueHD + EX
		DOLBY TrueHD + PLIIx Music
		DOLBY TrueHD + PLIIz
	Dolby Digital Plus	DOLBY DIGITAL Plus
		DOLBY DIGITAL Plus + EX
		DOLBY DIGITAL Plus + PLIIx Music
		DOLBY DIGITAL Plus + PLIIz
	DTS	DTS SURROUND
		DTS ES DSCRT 6.1
		DTS ES MTRX 6.1
DTS 96/24		
DTS + PLIIx Music		
DTS + PLIIz		
DTS-HD / DTS Express	DTS-HD HI RES	
	DTS-HD MSTR	
	DTS Express	
	DTS-HD + PLIIx Music	
	DTS-HD + PLIIz	
PCM multi-channel	MULTI CH IN	
	MULTI CH IN 7.1	
	MULTI IN + Dolby EX	
	MULTI IN + PLIIx Music	
	MULTI IN + PLIIz	
	MULTI CH STEREO	
	VIRTUAL	

- *1 2-channel also includes analog input.
- *2 When AUTO mode is selected, the sound mode that is compatible with the input signal is used for playback.
- *3 This mode plays back 2-channel sources in 5.1 or 7.1-channel playback. It cannot be selected when headphones are used, or when only front speakers are used.
- *4 Some listening modes cannot be selected, depending on the audio format or number of channels of the input signal. For details, see "Types of input signals, and corresponding sound modes" (page 146).

Operation button	Input signal	Listening mode	
GAME	2-channel *1	STEREO	
		AUTO *2	
		DOLBY PLIIx Game *3	
		DOLBY PLII Game *3	
		DOLBY PLIIz Height *3	
		MULTI CH STEREO	
	Multi-channel *4	STEREO	AUTO *2
			DOLBY DIGITAL
		Dolby Digital	DOLBY DIGITAL EX
			DOLBY DIGITAL + PLIIz
			DOLBY TrueHD
		Dolby TrueHD	DOLBY TrueHD + EX
			DOLBY TrueHD + PLIIz
			DOLBY DIGITAL Plus
		Dolby Digital Plus	DOLBY DIGITAL Plus + EX
			DOLBY DIGITAL Plus + PLIIz
			DTS
		DTS ES DSCRT 6.1	
		DTS ES MTRX 6.1	
		DTS 96/24	
DTS + PLIIz			
DTS + NEO:6			
DTS-HD / DTS Express	DTS-HD HI RES		
	DTS-HD MSTR		
	DTS Express		
	DTS-HD + PLIIz		
	DTS-HD + NEO:6		
PCM multi-channel	MULTI CH IN		
	MULTI CH IN 7.1		
	MULTI IN + Dolby EX		
	MULTI IN + PLIIz		
	MULTI CH STEREO		
PURE	All	VIRTUAL	
		DIRECT	
		PURE DIRECT	
		AUTO *2	

- *1 2-channel also includes analog input.
- *2 When AUTO mode is selected, the sound mode that is compatible with the input signal is used for playback.
- *3 This mode plays back 2-channel sources in 5.1 or 7.1-channel playback. It cannot be selected when headphones are used, or when only front speakers are used.
- *4 Some listening modes cannot be selected, depending on the audio format or number of channels of the input signal. For details, see "Types of input signals, and corresponding sound modes" (page 146).

Views on the TV screen or display

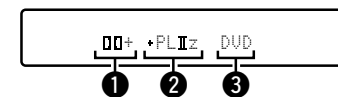

- 1 Shows a decoder to be used.
 - A DOLBY DIGITAL Plus decoder is displayed as "Dolby+".
- 2 Shows a decoder that creates sound output from the surround back speakers.
 - "+ PLIIz" indicates the front height sound from front height speakers.
- 3 Shows the name of the input source being played back.

□ Description of listening mode types

Dolby listening mode

Listening mode type	Description
DOLBY PLIIx*1	This mode can be selected when the Dolby Pro Logic IIx decoder is used to play back 2-channel sources in 6.1/7.1-channel surround sound including the surround back channel(s). By adding the surround back channel(s), a more enveloping surround environment is produced, compared to Dolby Pro Logic II. There are three playback modes: "Movie" mode that is optimized for movie playback, "Music" mode that is optimized for music playback, and "Game" mode that is optimized for game play.
DOLBY PLII	This mode can be selected when the Dolby Pro Logic II decoder is used to play back 2-channel sources in 5.1-channel surround sound with an enveloping surround sound experience.
DOLBY PLIIz*2	This mode can be selected when the Dolby Pro Logic IIz decoder is used to play back 2-channel sources in 7.1-channel surround sound with added front height channels. By adding front height channels, the front soundstage becomes dramatically taller, simulating the effect of listening in a large movie theater or concert hall.
DOLBY DIGITAL	This mode can be selected when playing sources recorded with Dolby Digital.
DOLBY DIGITAL EX*1	Using the Dolby Digital EX decoder, this mode plays Dolby Digital sources in 6.1/7.1 channel surround sound with added surround back channel(s). By adding surround back channel(s), sounds can be heard coming at you from behind and not just from the sides.
DOLBY TrueHD	This mode can be selected when playing sources recorded in Dolby TrueHD.
DOLBY DIGITAL Plus	This mode can be selected when playing sources recorded with Dolby Digital Plus.

*1 This can be selected when "Speaker Config." – "Surr. Back" ([page 124](#)) is not set to "None".

*2 This can be selected when "Speaker Config." – "Front Height" ([page 124](#)) is not set to "None".

DTS listening mode

Listening mode type	Description
DTS NEO:6	This mode can be selected when a DTS NEO:6 decoder is used to play back 2-channel source in 6.1/7.1-channel surround sound including the surround back channel. There is a "Cinema" mode optimized for movie playback, and a "Music" mode optimized for music playback.
DTS SURROUND	This mode can be selected when playing sources recorded in DTS.
DTS ES DSCRT6.1*1	This mode is suitable for playing discs recorded in DTS-ES. The surround back channel added using the discrete method is played as an independent channel. Since all channels are independent, the 360-degree spacial expressiveness and sound localization are enhanced.
DTS ES MTRX6.1*2	This mode is suitable for playing discs recorded in DTS-ES. The surround back channel added to the surround-left and surround-right channels by a matrix encoder at software recording time is decoded by this unit's matrix decoder and played from each channel (surround left, surround right, surround back).
DTS 96/24	This mode can be selected when playing sources recorded in DTS 96/24.
DTS-HD	This mode can be selected when playing sources recorded in DTS-HD.
DTS Express	This mode can be selected when playing sources recorded in DTS Express.

*1 This mode can be selected when only one surround back speaker is used and no front height speaker is used.

*2 This can be selected when "Speaker Config." – "Surr. Back" ([page 124](#)) is not set to "None".

PCM multi-channel listening mode

Listening mode type	Description
MULTI CH IN	This mode can be selected when playing multi-channel PCM sources from a disc player.

Original listening mode

Listening mode type	Description
MULTI CH STEREO	This mode is for enjoying stereo sound from all speakers. Stereo audio (2 channel) sources are played back via the front (L/R) speakers, the surround speakers and if connected the surround back speakers.
VIRTUAL	This mode lets you experience an expansive surround sound effect when playing back through just the front (L/R) speakers only, and when listening with stereo headphones.

AUTO listening mode

Listening mode type	Description
AUTO	In this mode, the type of digital signal input, such as Dolby Digital, Dolby TrueHD, Dolby Digital Plus, DTS, DTS-HD, PCM (multi-channel) is detected, and the playback mode switches automatically to the corresponding mode. If the input signal is analog or PCM (2-channel), stereo playback is used.

STEREO listening mode





Listening mode type	Description
STEREO	This mode plays 2-channel stereo audio with no additional surround sound processing. <ul style="list-style-type: none"> • Sound is output from the front left and right speakers, and subwoofer if connected. • When multi-channel signals are inputted, they are mixed down to 2-channel audio and are played back with no additional surround sound processing.

Direct listening mode

Listening mode type	Description
DIRECT	This mode provides a direct input-to-output path with minimal audio processing, bypassing any unnecessary stages for purest sound.
PURE DIRECT	This mode provides the direct audio signal path benefit of the Direct mode along with disabling additional stages that might possibly have an affect on sound quality. In Pure Direct mode, the following elements are turned off: <ul style="list-style-type: none"> • The front panel display and its driver circuitry are shut down. • The analog video input/output switcher and processor is disabled.

Advanced instructions

Here we explain functions and operations in more detail so that you can maximize your enjoyment with this unit.

- **Installation/connection/setup of speakers (Advanced)**  [page 79](#)
- **Connections (Advanced connection)**  [page 93](#)
- **Playback (Advanced operation)**  [page 95](#)
- **Playback in ZONE2 (Separate room)**  [page 101](#)
- **How to make detailed settings**  [page 103](#)

Installation/connection/setup of speakers (Advanced)

Procedure for speaker settings

Speaker installation



Speaker connection (👉 page 81)



Set up speakers (👉 page 91)

Speaker installation

- Determine the speaker system depending on the number of speakers you are using and install each speaker and subwoofer in the room. Here, we explain how to install the speakers using a typical example.
- The speaker impedance should be from 6 to 16 Ω/ohms.

This unit is compatible with Dolby Pro Logic IIz (👉 page 150) and DTS Neo:6 (👉 page 151) which offers an even wider and deeper surround sensation. When using Dolby Pro Logic IIz, install front height speakers.



Use the illustration below as a guide for how high each speaker should be installed. The height does not need to be exactly the same.

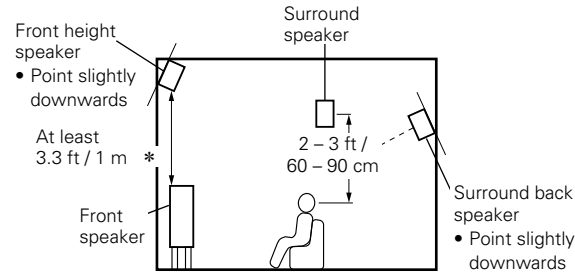

[Viewed from the side]

* Recommended for Dolby Pro Logic IIz

When 7.1-channel speakers are installed using surround back speakers

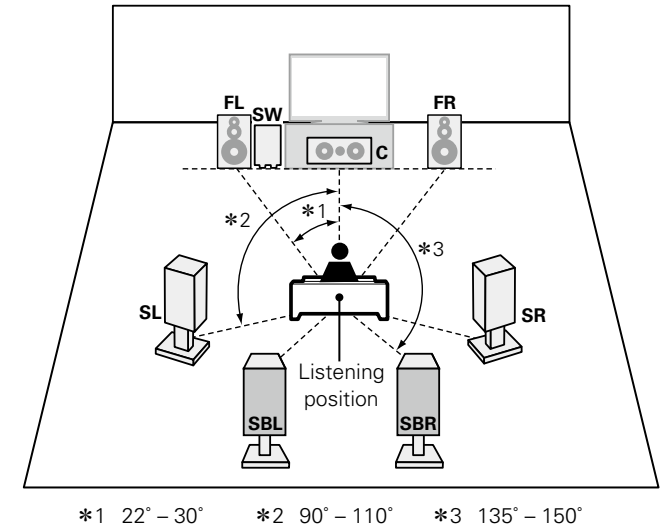

NOTE

You cannot have audio output from the surround back speakers and front height speakers simultaneously.

[Speaker abbreviations]

FL Front speaker (L)	SL Surround speaker (L)
FR Front speaker (R)	SR Surround speaker (R)
C Center speaker	SBL Surround back speaker (L)
SW Subwoofer	SBR Surround back speaker (R)

When 7.1-channel speakers are installed using front height speakers

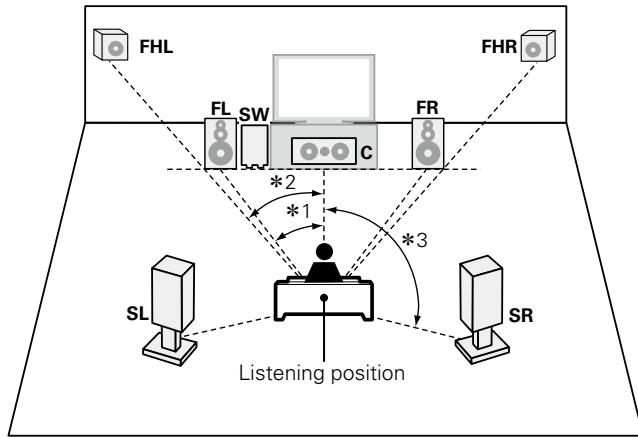

*1 22° - 30° *2 22° - 45° *3 90° - 110°

[Speaker abbreviations]

- | | |
|-----------------------------|-------------------------------------|
| FL Front speaker (L) | SL Surround speaker (L) |
| FR Front speaker (R) | SR Surround speaker (R) |
| C Center speaker | SB Surround back speaker |
| SW Subwoofer | FHL Front height speaker (L) |
| | FHR Front height speaker (R) |

When 6.1-channel speakers are installed

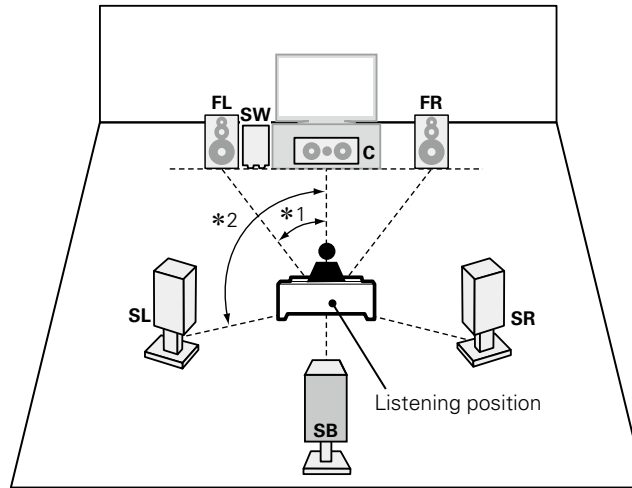

*1 22° - 30° *2 90° - 110°

When 5.1-channel speakers are installed

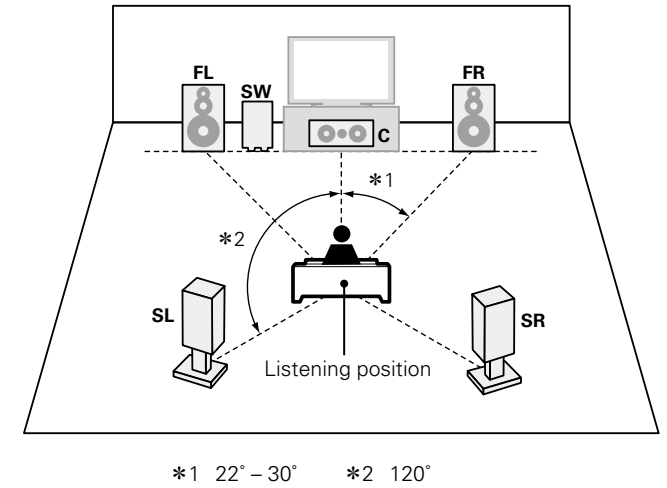

*1 22° - 30° *2 120°

When Front A/B speakers are installed

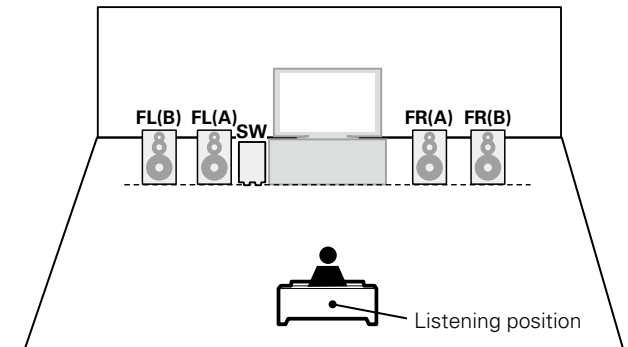

Speaker connection

Here we connect the speakers in the room to this unit.
This section explains how to connect them using typical examples.

- ❑ **Connecting 7.1-channel speakers using surround back speakers** ([page 83](#))
- ❑ **Connecting 7.1-channel speakers using front height speakers** ([page 84](#))
- ❑ **Connecting 6.1-channel speakers using one surround back speaker** ([page 85](#))
- ❑ **Connecting 5.1-channel speakers** ([page 86](#))
- ❑ **Connecting front A/B speakers** ([page 87](#))
- ❑ **Connecting 2.1-channel speakers** ([page 88](#))
- ❑ **Connecting front speakers with a bi-amp connection** ([page 89](#))
- ❑ **Connecting a front speaker that uses a power amplifier** ([page 90](#))

NOTE

- Disconnect this unit's power plug from the power outlet before connecting the speakers. Also, turn off the subwoofer.
- Connect so that the speaker cable core wires do not protrude from the speaker terminal. The protection circuit may be activated if the core wires touch the rear panel or if the + and - sides touch each other ([page 151](#) "Protection Circuit").
- Never touch the speaker terminals while the power cord is connected. Doing so could result in electric shock. When the "Setup Assistant" is running, follow the instructions in the "Setup Assistant" screen for making connections. (Power is not supplied to the speaker terminals while the "Setup Assistant" is running.)
- Use speakers with the speaker impedances shown below.

Speaker terminals	Speaker impedance
FRONT	6 – 16 Ω/ohms
CENTER	
SURROUND	
SURROUND BACK	

Connecting the speaker cables

Carefully check the left (L) and right (R) channels and + (red) and - (black) polarities on the speakers being connected to this unit, and be sure to connect the channels and polarities correctly.

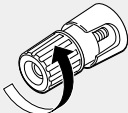
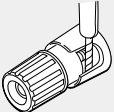
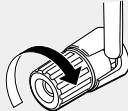
- 1** Peel off about 3/8 inch (10 mm) of sheathing from the tip of the speaker cable, then either twist the core wire tightly or terminate it.
 
- 2** Turn the speaker terminal counterclockwise to loosen it.
 
- 3** Insert the speaker cable's core wire to the hilt into the speaker terminal.
 
- 4** Turn the speaker terminal clockwise to tighten it.
 

Cables used for connections

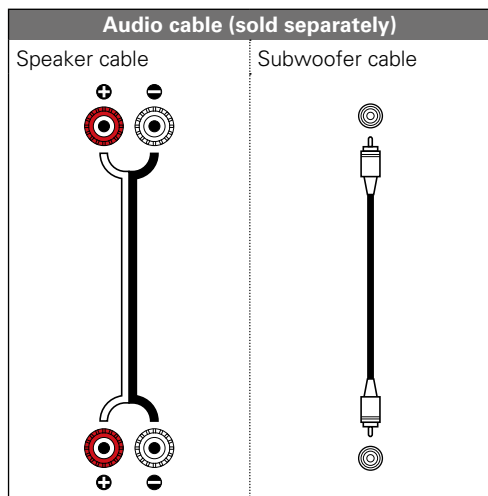

Connecting the subwoofer

Use a subwoofer cable to connect the subwoofer.

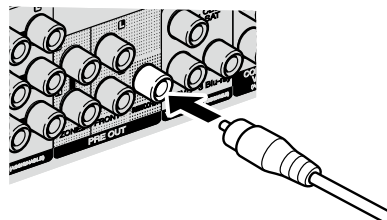

About the speaker cable label (supplied) for channel identification

The channel display section for speaker terminals on the rear panel is color-coded for each channel to be identifiable.

Speaker terminals	Color
FRONT L	White
FRONT R	Red
CENTER	Green
SURROUND L	Light blue
SURROUND R	Blue
SURROUND BACK L	Beige
SURROUND BACK R	Brown

Attach the speaker cable label for each channel to its speaker cable as shown in the diagram. Then, make connection so that the color of the speaker terminal matches that of the speaker cable label.

[How to attach the speaker cable label]

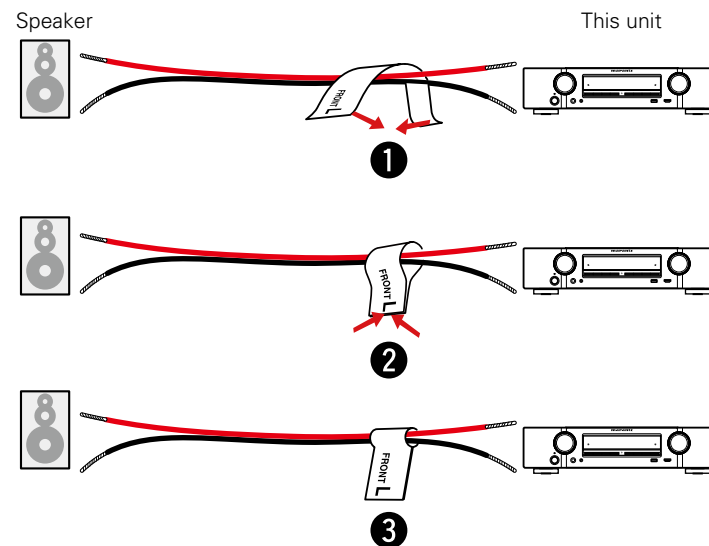

Connecting 7.1-channel speakers using surround back speakers

The illustration on the right shows a connection example for performing 7.1-channel playback using the surround back speakers.

To perform 7.1-channel playback using the surround back speakers, set "Assign Mode" to "Surround Back" in steps 3 to 5 for "Set up "Amp Assign"" ([page 91](#)).

NOTE

- For speaker cable connections, see [page 82](#).
- For speaker impedance, see [page 81](#).

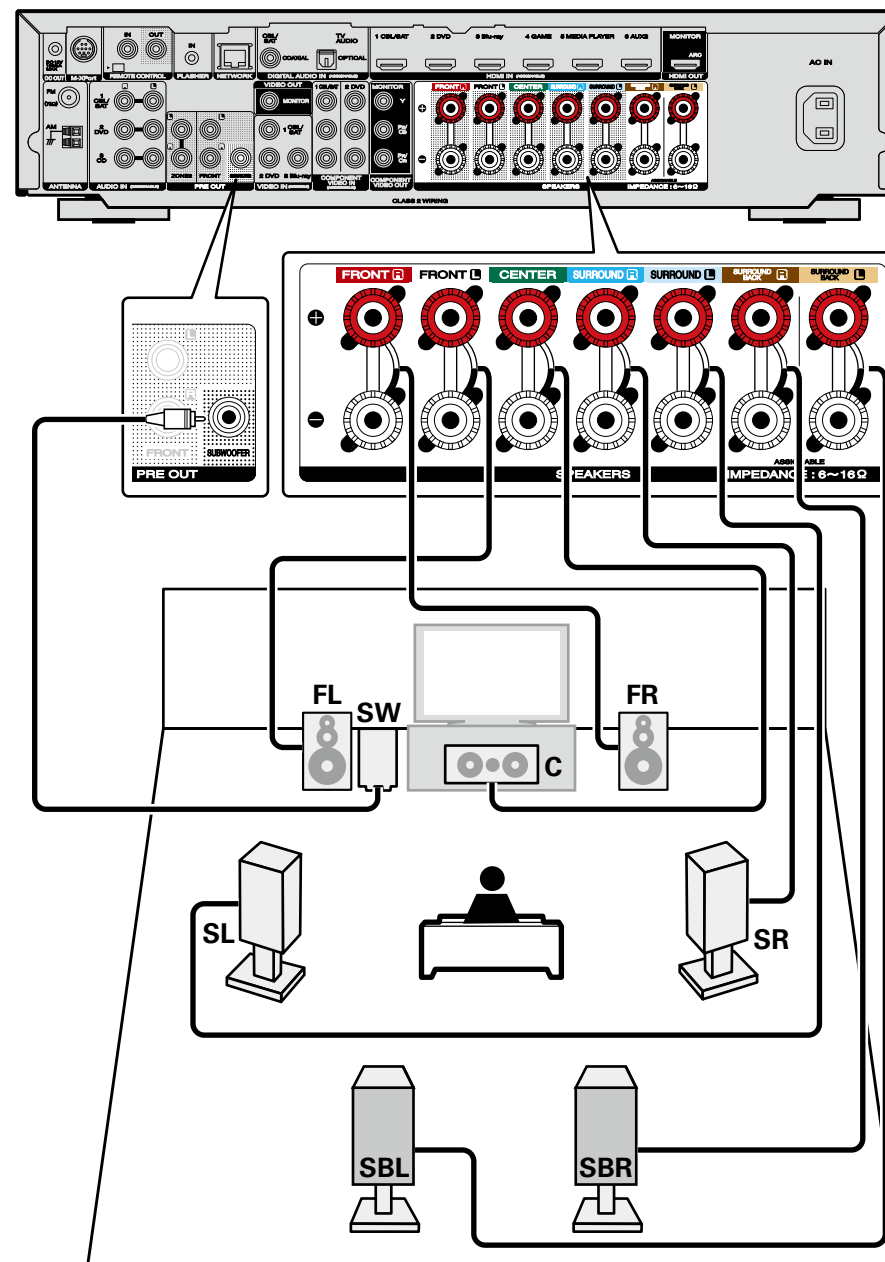

Connecting 7.1-channel speakers using front height speakers

The illustration on the right shows a connection example for performing 7.1-channel playback using the front height speakers.

To perform 7.1-channel playback using the front height speaker, set "Assign Mode" to "Front Height" in steps 3 to 5 for "Set up "Amp Assign"" (refer to [page 91](#)).

NOTE

- For speaker cable connections, see [page 82](#).
- For speaker impedance, see [page 81](#).

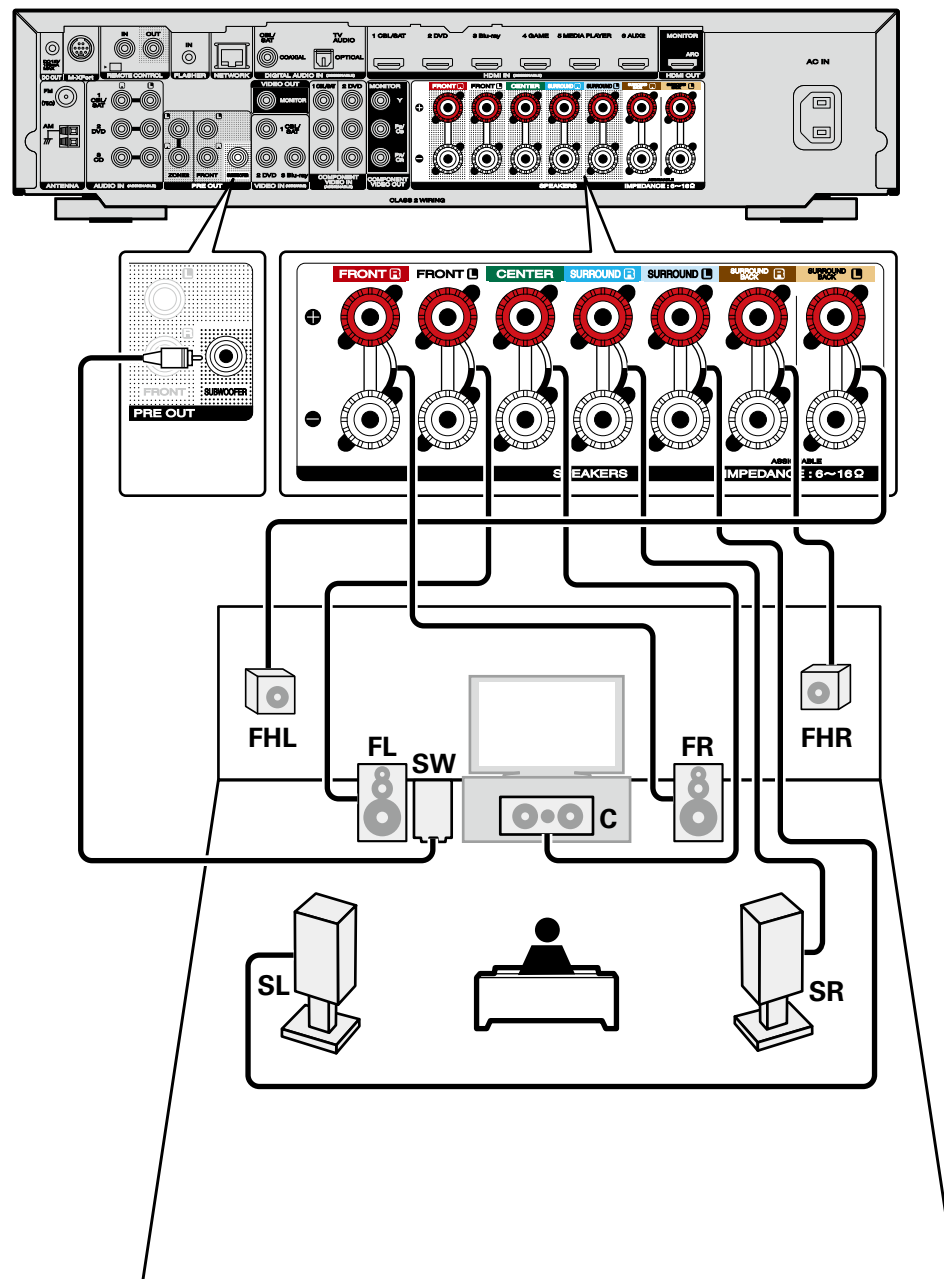

Connecting 6.1-channel speakers using one surround back speaker

If using only one surround back speaker, connect to the "L" side of the SURROUND BACK terminal. For speaker settings in this case, see "When 6.1-channel speakers are installed" ([page 80](#)). To perform 6.1-channel playback using the surround back speaker, set "Assign Mode" to "Surround Back" in steps 3 to 5 for "Set up "Amp Assign"" ([page 91](#)). Also use the "Speaker Config." setting ([page 124](#)) to set "Surr. Back" to "1spkr".

NOTE

- For speaker cable connections, see [page 82](#).
- For speaker impedance, see [page 81](#).

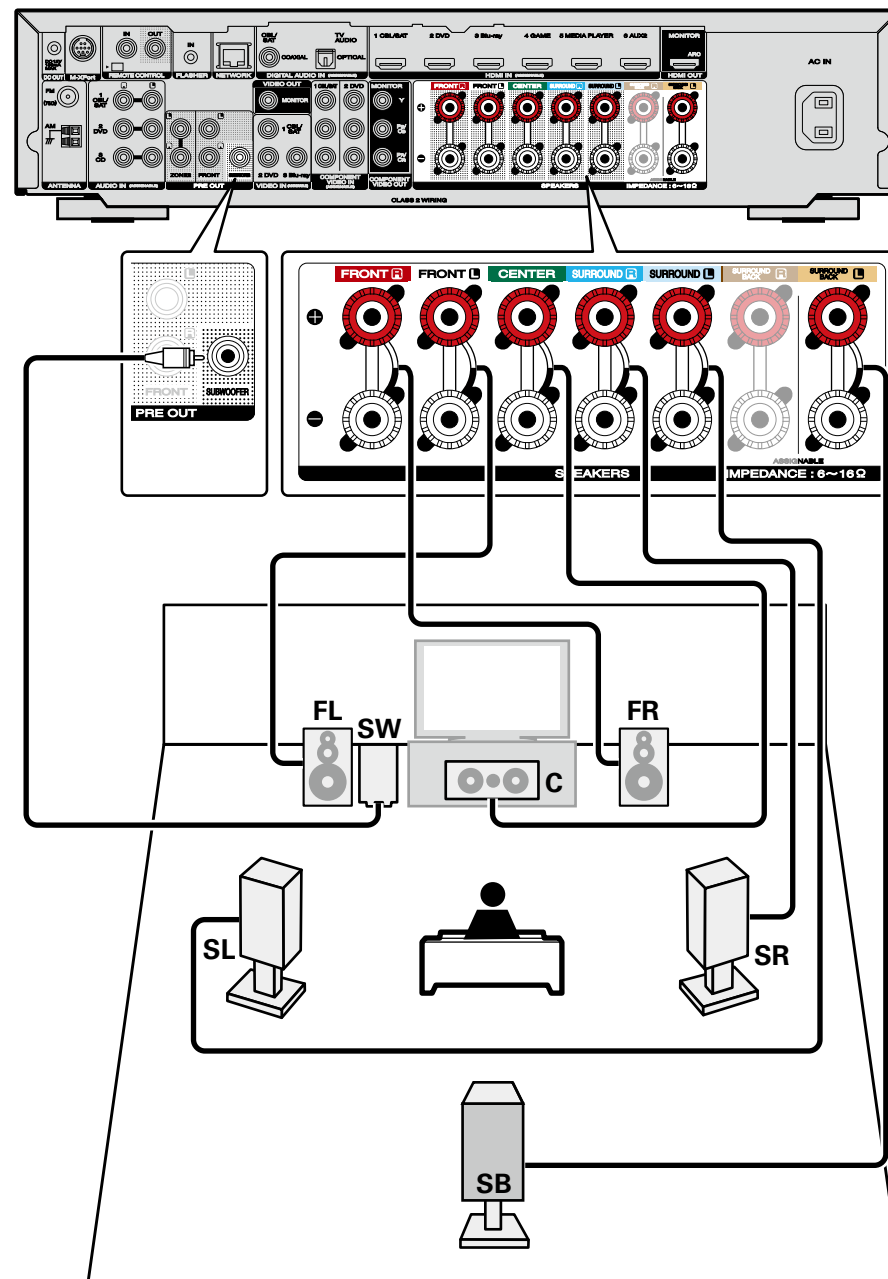

Connecting 5.1-channel speakers

To perform 5.1-channel playback, set "Assign Mode" to "Surround Back" in steps 3 to 5 for "Set up "Amp Assign"" (page 91).

NOTE

- For speaker cable connections, see [page 82](#).
- For speaker impedance, see [page 81](#).

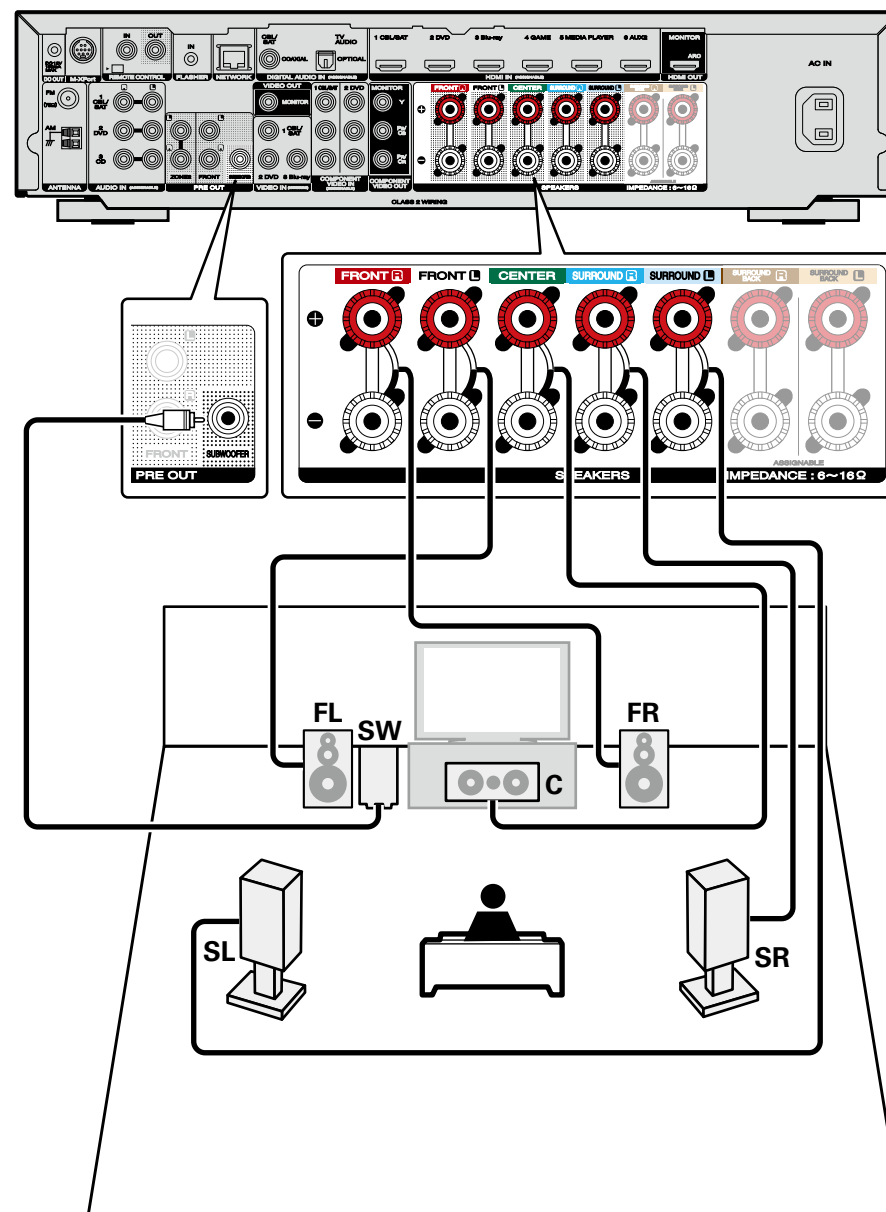

Connecting front A/B speakers

You can connect a second set of speakers to this unit and use them for playback. In this case, set "Assign Mode" to "Front B" in steps 3 to 5 for "Set up "Amp Assign"" ([page 91](#)).



For multi-channel playback, connect center, surround, surround back, and front speakers and a subwoofer. Front speakers can be used separately, depending on the speaker's specifications or playback source such as front speakers (A) for multichannel playback and front speakers (B) for 2-channel playback ([page 126](#) "Front Speaker").

NOTE

- For speaker cable connections, see [page 82](#).
- For speaker impedance, see [page 81](#).

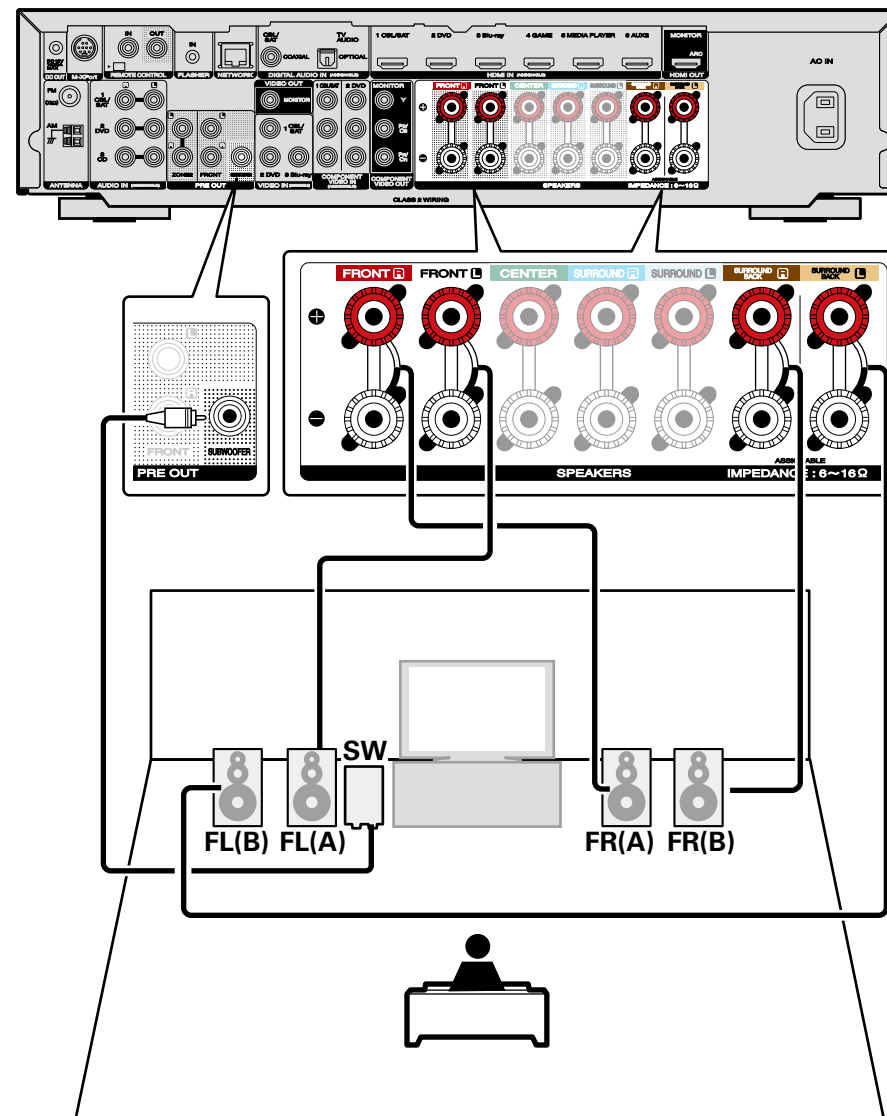

Connecting 2.1-channel speakers

NOTE

- For speaker cable connections, see [page 82](#).
- For speaker impedance, see [page 81](#).

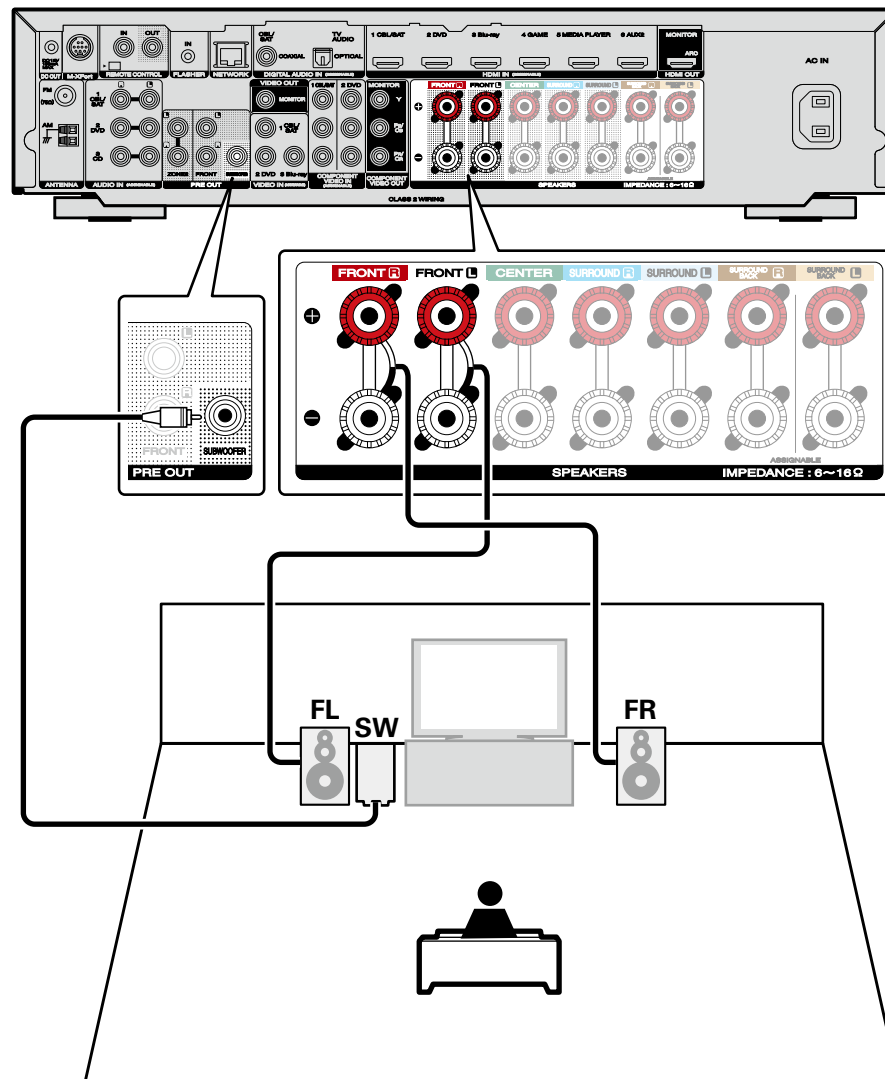

Connecting front speakers with a bi-amp connection

Some audiophile loudspeakers can be connected to an amplifier with two separate amp-to-speaker connections per each speaker. One amplifier channel's output is hooked up to the speaker's bass driver (woofer), while the other amplifier drives the upper range transducers (tweeter, or in some cases midrange and tweeter). This connection method has one amplifier channel driving one half of the bi-amp speaker, and avoids electrical interference between the speaker's bass and treble drivers and the driving amplifier channels. You can assign 4 amp channels to connect to one pair of bi-amp capable speakers. Bi-amp capable speakers always have two sets of speaker input connector pairs, one for the bass range and one for the treble range. If you're unsure about whether or not your speakers are bi-amp capable, consult the owner's manual that came with the speakers.

In this case, set "Assign Mode" to "Bi-AMP" in steps 3 to 5 for "Set up "Amp Assign"" ([page 91](#)).



For multi-channel playback, connect front, center, and surround speakers and a subwoofer.

NOTE

- For speaker cable connections, see [page 82](#).
- For speaker impedance, see [page 81](#).
- When making bi-amp connections, be sure to remove the short-circuiting plate or wire between the speaker's woofer and tweeter terminals.

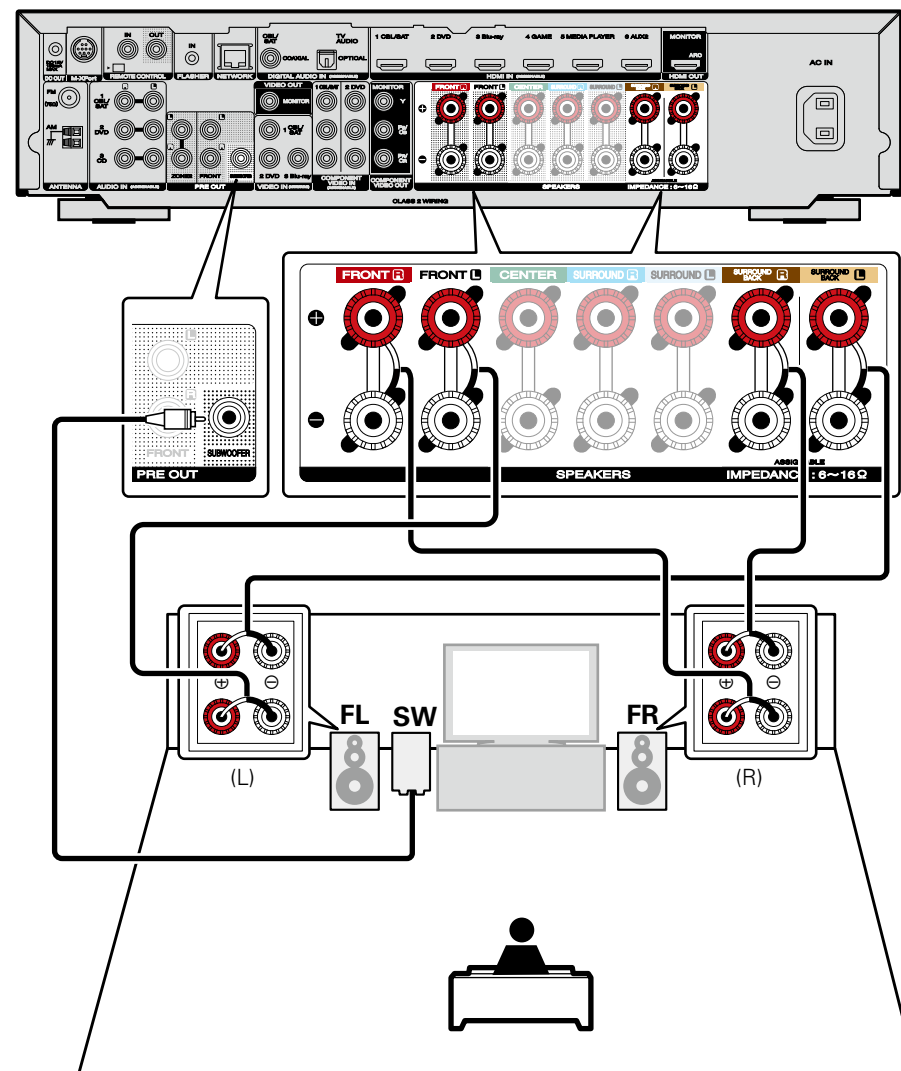

Connecting a front speaker that uses a power amplifier

This unit supports connection of a front speaker that uses an external power amplifier to increase its output. Connect a separately sold power amplifier to the PRE OUT (FL/FR) connector of this unit.

NOTE

- For speaker cable connections, see [page 82](#).
- For speaker impedance, see [page 81](#).

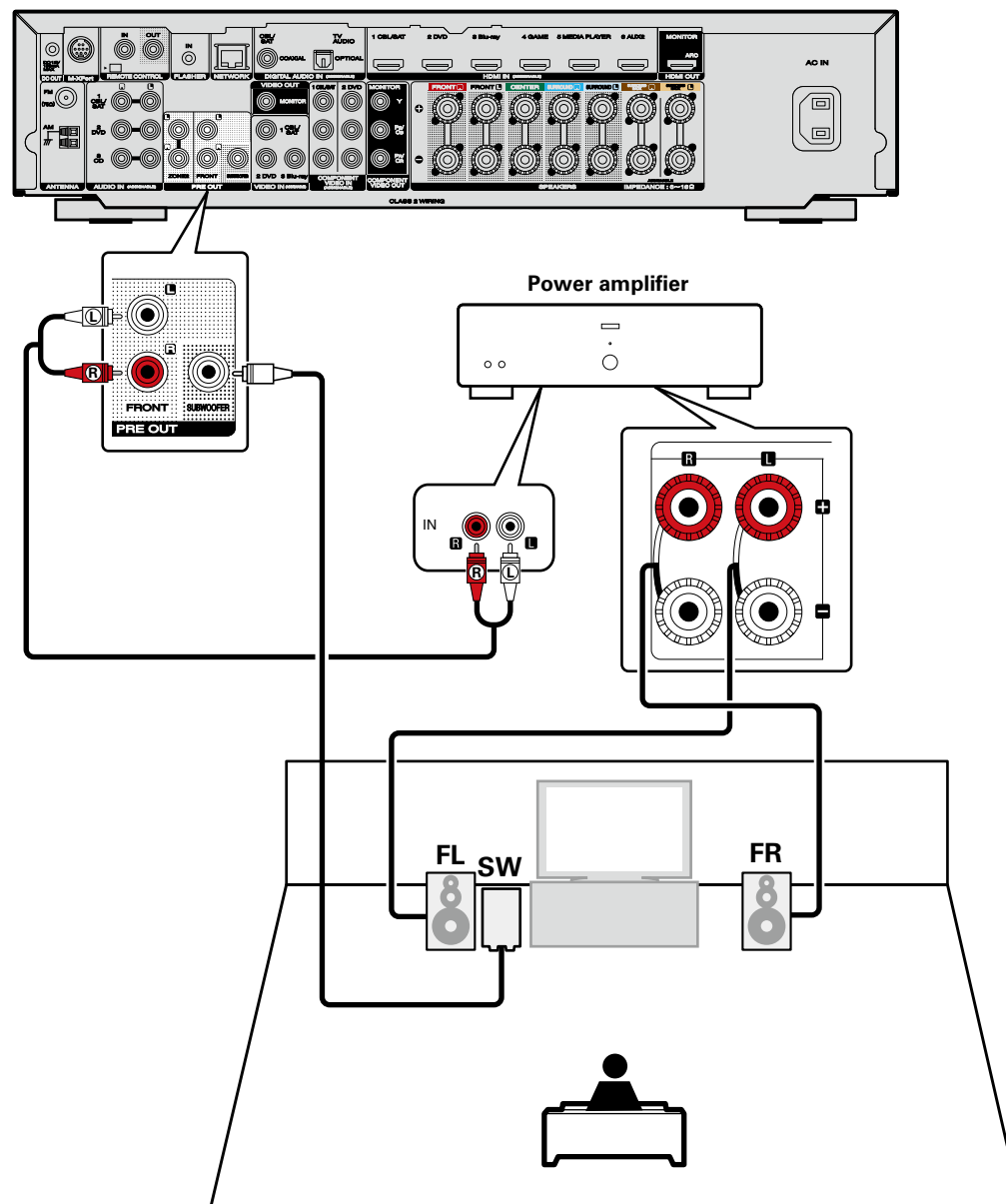

Set up speakers

 around items indicate the settings.

This section describes detailed settings for Audyssey® Setup.

First install and connect the speakers to this unit.

Before Audyssey® Setup measurement, the settings shown below can be made.

- Changing the amplifier assignment (Amp Assign)

The signal output from the SURROUND BACK speaker terminals of this unit can be switched to match your speaker environment ([page 91](#) “Set up “Amp Assign””).

- Setting the channels to be used (Channel Select)

If channels that are not to be used are set in advance, measurement for the set channels is skipped, and measuring time can be reduced. You can also change the number of surround back speakers ([page 92](#) “Set up “Channel Select””).

1 Set up the zone mode

Press **MAIN** to switch the zone mode.
MAIN lights.

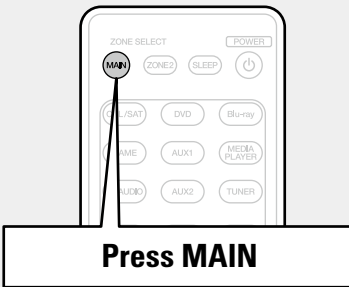

2 Connect the Setup and measurement microphone.

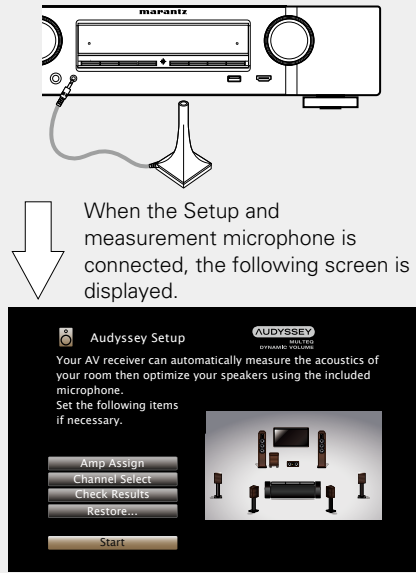

When the Setup and measurement microphone is connected, the following screen is displayed.

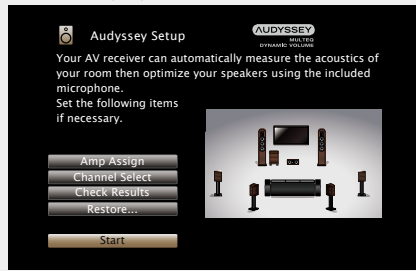

3 Set up “Amp Assign”

Use Δ / ∇ to select “Amp Assign”, and then press **ENTER**.

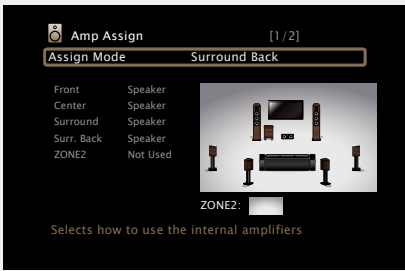
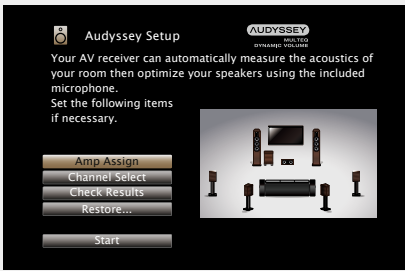

Front	Speaker
Center	Speaker
Surround	Speaker
Surr. Back	Speaker
ZONE2	Not Used

ZONE2:

Selects how to use the internal amplifiers

4 Select “Assign Mode”, and then press **ENTER.**

- 5** Use \triangleleft \triangleright to select the configuration of the connected speakers, and then press **ENTER**.

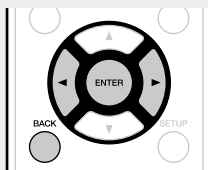

Surround Back Setting for 7.1-channel playback using surround back speakers.

ZONE2 Setting to assign the unit's built-in power amplifier for ZONE2 and output the audio in stereo.

Bi-AMP Setting to use the front speakers via the bi-amp connection.

Front B Setting to use the second set of front speakers for playback.

Front Height Setting for 7.1-channel playback using front height speakers.

- 6** Press \triangleleft or **BACK** to exit the "Amp Assign" setting.

7 Set up "Channel Select"

- Use \triangle ∇ to select "Channel Select", and then press **ENTER**.

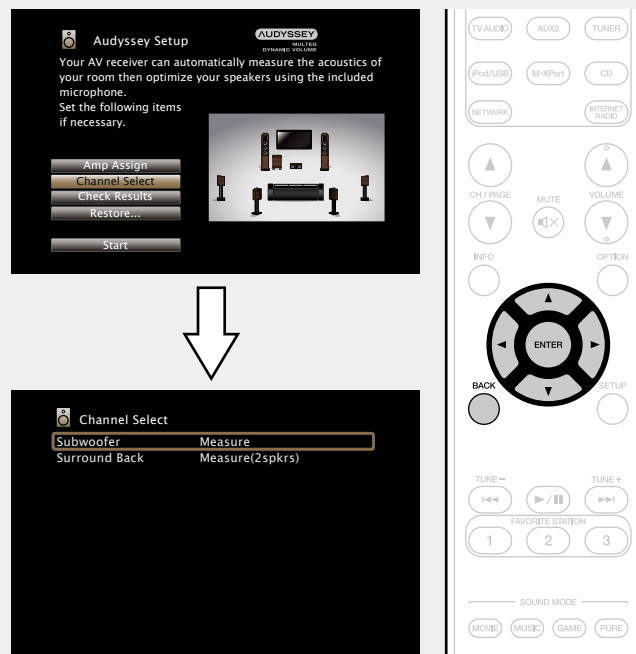

- 8** Use \triangle ∇ to select a channel, and then press **ENTER**.

- Front** Select for setting the front speakers to be used. In this case, go to step 9.
• "Front" can be set when "Assign Mode" is set to "Front B".
- Subwoofer** Select for no subwoofers to be used. In this case, go to step 10.
- Surround Back** Select the number of surround back speakers to be used. In this case, go to step 11.
• "Surround Back" can be set when "Assign Mode" is set to "Surround Back".

- 9** Use \triangleleft \triangleright to select a front speaker, and then press **ENTER**.

- A** Select this to use front speaker A.
- B** Select this to use front speaker B.
- A+B** Select this to use front speakers A and B simultaneously.

- 10** Use \triangleleft \triangleright to set whether or not a subwoofer channel is measured, and then press **ENTER**.

- Measure** Set for measuring a subwoofer.
- Skip** Set for no measuring of a subwoofer.

- 11** Use \triangleleft \triangleright to set whether or not a surround back channel is measured, and then press **ENTER**.

- Measure (2spkr)** Set for measuring two surround back speakers.
- Measure (1spkr)** Set for measuring a surround back speaker.
- Skip** Set for no measuring of a surround back speaker.

- 12** Press \triangleleft or **BACK**. Proceed to [page 24](#) **Preparation** step 5.

NOTE

After performing Audyssey® Setup, do not change the speaker connections or subwoofer volume. In event of a change, perform Audyssey® Setup again.

Connections (Advanced connection)

Connecting the REMOTE CONTROL connectors

Remotely connecting Marantz devices

□ Performing operations by RC on this unit without visual contact

- You can connect an external IR receiver to the REMOTE CONTROL connectors to perform operations on this unit with the supplied remote control unit without visual contact. This might be necessary if the unit is hidden in a cupboard or corner, so you can't directly point with the remote control unit to the device.
- To do this, disable the remote control signal receiving function ([see page 100](#) "Remote lock function").

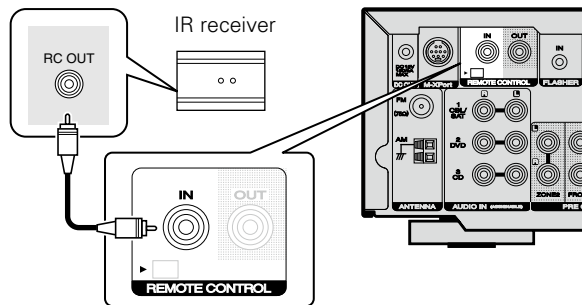

NOTE

When not connecting an IR receiver, make sure to enable the remote control signal receiving function. When the function is disabled, you can not perform operations with the remote control unit.

□ Remotely connecting Marantz devices

- When you are using a Marantz device other than this unit that supports remote connection, you can transmit remote control signals just by connecting the device to the REMOTE CONTROL IN/ OUT connector with a monaural cable.
- Set the remote control switch located on the rear panel of the connected audio component to "EXTERNAL" or "EXT." to use this feature.

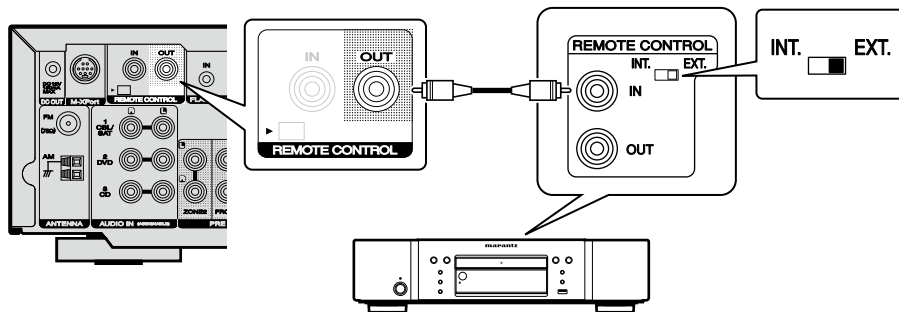

Remotely control a Marantz Blu-ray player by the Marantz Remote App

Marantz Blu-ray disc player of newer generation also can be controlled via a network receiver unit using the Marantz Remote App. Please ensure REMOTE CONTROL system of the receiver unit and the BD-Player is set up as shown in the previous section.

Connecting an external control device

DC OUT jack

When a device with DC IN jack is connected, the connected device's power on/standby can be controlled through linked operation to this unit.

The DC OUT jack outputs a maximum 12 V/150 mA electrical signal.

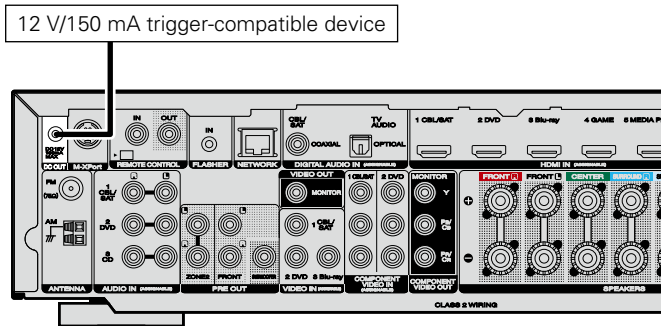

NOTE

- Use the monaural mini-plug cable for connecting DC OUT jacks. Do not use the stereo mini-plug cable.
- If the permissible trigger input level for the connected device is larger than 12 V/150 mA, or has shorted, the DC OUT jack cannot be used. In this case, turn off the power to the unit, and disconnect it.

Playback (Advanced operation)

Setup (👉 page 22)

Playback (Basic operation) (👉 page 29)

Selecting a listening mode (Sound Mode)
(👉 page 72)

Connections (Advanced connection) (👉 page 93)

- ❑ HDMI control function (👉 page 95)
- ❑ Sleep timer function (👉 page 96)
- ❑ Web control function (👉 page 97)
- ❑ Dual backup memory function (👉 page 99)
- ❑ Panel lock function (👉 page 99)
- ❑ Remote lock function (👉 page 100)
- ❑ Various memory functions (👉 page 100)

HDMI control function

A recent addition to the HDMI standard is CEC, which allows control signals from one device to communicate with another device via the HDMI cable connection. Not all HDMI-equipped devices allow .

❑ Operations possible by HDMI control

- **This unit's power off function can be linked to the TV power off operation.**
- **You can switch audio output devices with a TV operation.**
When you set "Output audio from amp" in the TV audio output setup operation, you can switch the AV receiver unit's power on.
- **You can adjust this unit's volume in the TV volume adjustment operation.**
- **You can switch this unit's input sources through linkage to TV input switching.**
- **When playing a disc player, this unit's input source switches to the appropriate source for that player.**
- **If you switch the input source of the unit to "TV AUDIO", you can play TV audio with this unit (👉 page 8 "About ARC (Audio Return Channel) function").**
- **When "HDMI Control" (👉 page 116) in the menu is set to "On", signals input to the HDMI input connector are output to the television or other device connected to the HDMI output connector, even if the power of this unit is in standby (pass-through function).**



To use this unit to play the audio of a TV that does not support the ARC function, connect the TV to this unit with an optical-digital or analog connection (👉 page 8).

❑ Setting procedure

- 1 Set the HDMI output connector corresponding with the HDMI control function.**
Set "HDMI Control" (👉 page 116) to "On".
- 2 Turn the power on for all the devices connected by HDMI cable.**
- 3 Set the HDMI control function for all devices connected by HDMI cable.**
 - Please consult the operating instructions for the connected devices to check the settings.
 - Carry out steps 2 and 3 should any of the devices be unplugged.
- 4 Switch the television input to the HDMI input connected to this unit.**
- 5 Switch this unit input to the HDMI input source and check if the picture from the player is ok.**
- 6 When you turn the TV's power to standby, check that the power of this unit also goes to standby.**



If the HDMI control function does not operate properly, check the following points.

- Is the TV or player compatible with the HDMI control function?
- Is "HDMI Control" ([page 116](#)) set to "On"?
- Is "Power Off Control" ([page 116](#)) set to "All" or "Video"?
- Are the HDMI control function settings of all devices correct?

NOTE

- When "HDMI Control" is set to "On", it consumes more standby power.
- The HDMI control function controls operations of a TV that is compatible with the HDMI control function. Make sure that the TV and HDMI are connected when you perform HDMI control.
- Some functions may not operate depending on the connected TV or player. Check the owner's manual of each device for details beforehand.
- When "Power Off Control" on the menu is set to "Off" ([page 116](#)), this unit is not set to standby even if the connected device is in the standby mode.
- When connection changes are implemented, such as adding connections to HDMI devices, linked operations may be initialized. In this case, you will need to reconfigure the settings.
- When "HDMI Control" is set to "On", it is not possible to assign an HDMI connector to "TV AUDIO" at "Input Assign" ([page 120](#)).
- Should any of the operations below be performed, the interlocking function may be reset, in which case, repeat steps 2 and 3.
 - "Input Assign" – "HDMI" ([page 120](#)) setting has changed.
 - There is a change to the connection between the devices and the HDMI, or an increase in devices.

Sleep timer function

- You can have the power automatically switched to standby once a set time has elapsed. This is convenient for viewing and listening while going to sleep.
- The sleep timer function can be set for each zone ([page 102](#) "Sleep timer function"). (The MAIN ZONE setting method is explained here.)

- 1 Press MAIN to switch the zone mode.**
MAIN lights.

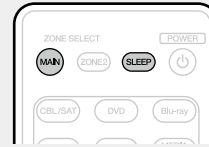

- 2 Press SLEEP and display the time you want to set.**
The SLEEP indicator on the display lights.

- The time switches as shown below each time SLEEP is pressed.

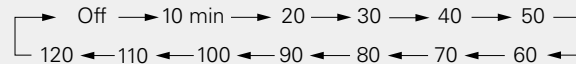

To confirm the countdown time before putting the unit to sleep

Press **SLEEP**.

"Sleep : *min" appears on the display.

* Countdown time

To cancel the sleep timer

Press **SLEEP** to set "Off".

The **SLEEP** indicator on the display turns off.



- The sleep timer setting is canceled if this unit's power is set to standby.
- The sleep timer function can be set separately for the different zones ([page 102](#) "Sleep timer function").

NOTE

The sleep timer function cannot turn off the power of devices connected to this unit. To turn off the power of those connected devices, set up sleep timers on the connected devices themselves.

Web control function

You can control this unit from a web control screen on a web browser.



- This unit and the PC need to be connected to the network properly (page 20 “Connecting to a home network (LAN)”) in order to use the web control function.
- Depending on the settings of your security-related software, you may not be able to access this unit from your PC. If this is the case, then change the settings of the security-related software.

1 Switch the “IP Control” setting to “Always On” (page 128).

2 Check the IP address of this unit with “Information” (page 128).

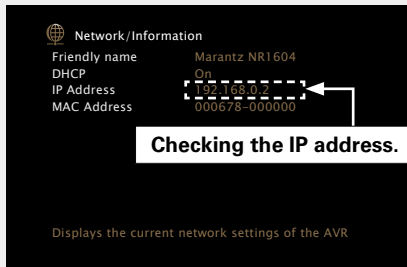

3 Start up the web browser.

4 Enter the IP address of this unit in browser’s address box.

For example, if the IP address of this unit is “192.168.0.2”, enter “http://192.168.0.2”.

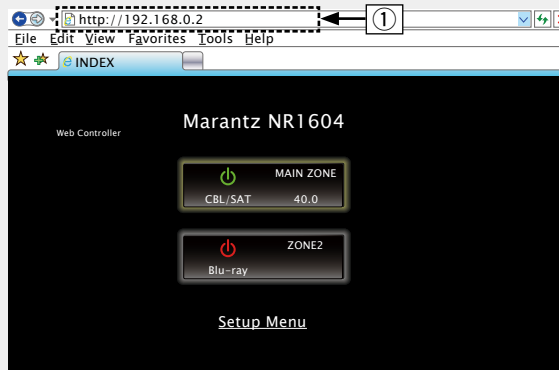

① Entering the IP address.

- By adding this unit’s IP address to the browser’s bookmark, you can display the web control screen using the bookmark function the next time you use the browser. If you are using a DHCP server and “IP Control” (page 128) is set to “Off In Standby”, turning the power on/off changes the IP address.

5 When the top menu is displayed, click on the menu item you want to operate.

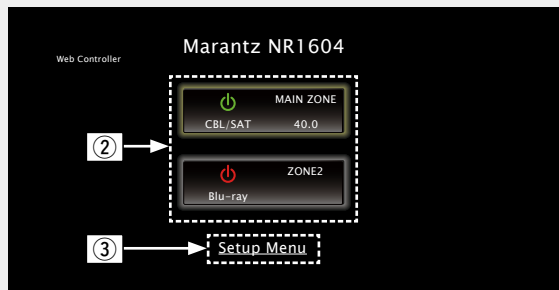

- ② Click when you select the zone to operate. (Example 1)
- ③ Click when you operate the setup menu. (Example 2)

6 Operate.

[Example 1] MAIN ZONE control screen

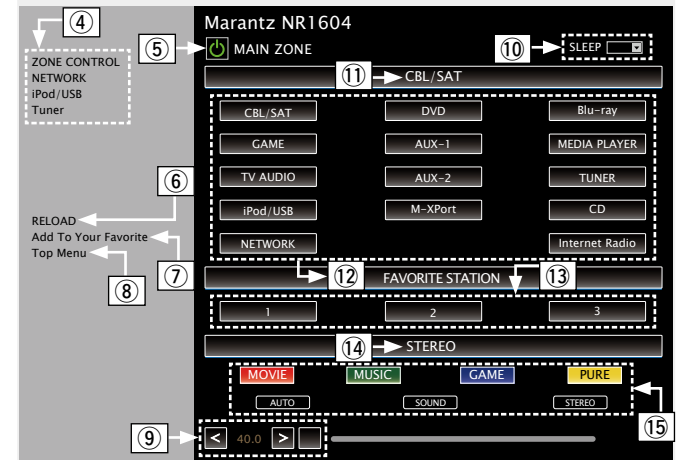

- ④ Click the menu item from which you want to make settings.
- ⑤ Click when you perform the power on/off function of the unit.
- ⑥ Click when you update to the latest information.
If changes are made during normal operation, then be sure to click this button to refresh the information with the latest status.
- ⑦ Click to add a setting to “Favorites” in your browser.
We recommend registering the setting screens for the different zones in the browser’s favorites so as not to accidentally perform menu operations for zones you do not intend to operate.
- ⑧ Click to return to the top menu.
- ⑨ To adjust the main volume, click “<”, “>”, or the volume display.
- ⑩ Click “v” to set the sleep timer function.
- ⑪ Displays the name of the selected input source.
- ⑫ Click a button to change the input source.
- ⑬ Callback your favorite content.
- ⑭ Displays the sound mode.
- ⑮ The sound mode switches when you click the button.

[Example 2] Setup menu screen

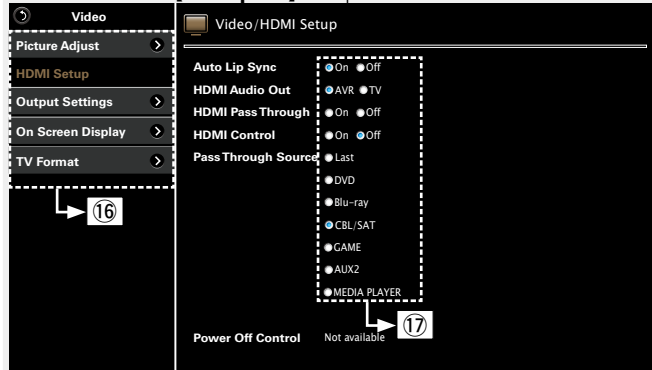

- 16 Click the menu item from which you want to make settings.
The display on the right becomes the individual setting screens.
- 17 Click an item to make a setting.

[Example 3] Network audio operating screen

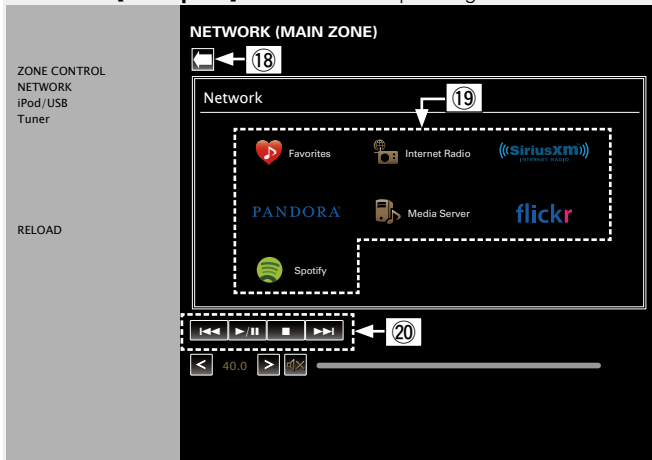

- 18 Click to return to the previous screen.
- 19 Click the content you want to operate.
- 20 Use to operate content.

Dual backup memory function

The unit stores settings information in nonvolatile memory even when the main power supply is turned off. Using the Dual Backup Memory function, you can write settings information to another memory area to back up saved settings for recovery anytime as needed. Remembering set details (Backup).

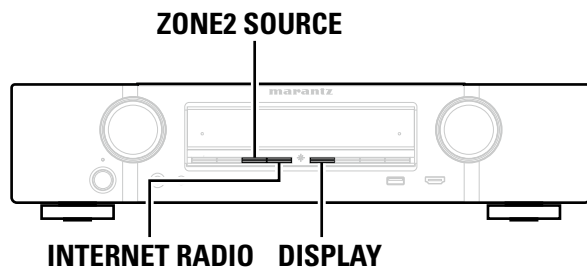

Remembering set details (Backup)

Set the unit in the state you want remembering, and press and hold **INTERNET RADIO** and **ZONE2 SOURCE** for at least 3 seconds.

"MEMORY SAVING" is shown in the display, and the setting details are remembered.

NOTE

- The volume is not remembered.
- If remembered details are overwritten, the previously remembered contents are deleted.

Recalling remembered details (Recovery)

Press and hold **DISPLAY** and **INTERNET RADIO** together for at least 3 seconds.

"MEMORY LOAD" is shown in the display, and the remembered details are recalled.

NOTE

- If there is no remembered data, "NO BACKUP" is shown in the display, and no remembered details are recalled.
- As the volume cannot be recalled, it returns to the factory setting volume.

Panel lock function

To prevent accidental operation of this unit, you can disable operation of the buttons on the front panel.

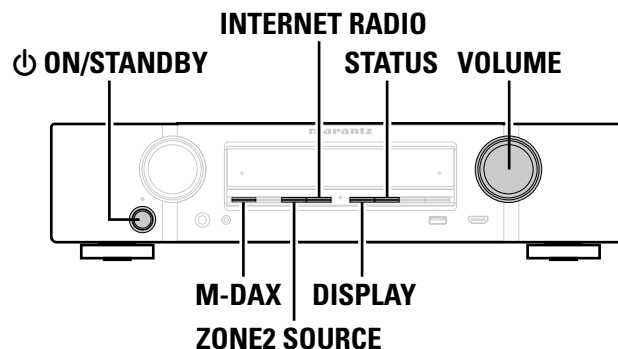

Disabling all key button operations

1 Press **ON/STANDBY** while you press and hold **DISPLAY** and **M-DAX** with the unit in standby mode.

2 Press **INTERNET RADIO** or **ZONE2 SOURCE** to select "FP/VOL LOCK On".

3 Press **STATUS** to enter the setting.
All button operations except **ON/STANDBY** are disabled.

Disabling all button operations except VOLUME

1 Press **ON/STANDBY** while you press and hold **DISPLAY** and **M-DAX** with the unit in standby mode.

2 Press **INTERNET RADIO** or **ZONE2 SOURCE** to select "FP LOCK On".

3 Press **STATUS** to enter the setting.
All button operations except **ON/STANDBY** and **VOLUME** are disabled.

Canceling the Panel lock function

1 Press **ON/STANDBY** while you press and hold **DISPLAY** and **M-DAX** with the unit in standby mode.

2 Press **INTERNET RADIO** or **ZONE2 SOURCE** to select "FP LOCK *Off".
(* The currently set mode.)

3 Press **STATUS** to enter the setting.
The Panel lock function is canceled.



Even when the Panel lock function is set, you can operate the unit using the remote control unit.

Remote lock function

- When not connecting an IR receiver, disable the Remote lock function. When the function is enabled, you can not perform operations with the remote control unit.
- By default, this function is disabled.

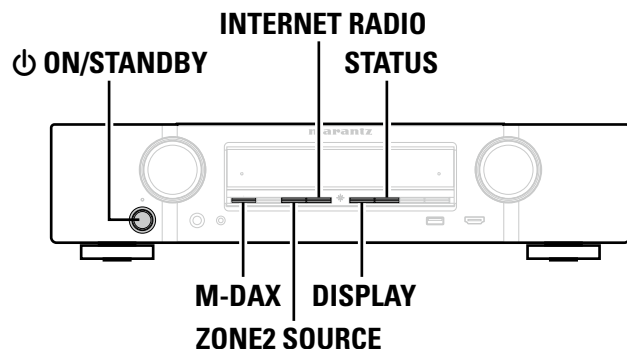

❑ Disabling the sensor function of the remote control unit

- 1** When the main unit is in standby mode, press **ON/STANDBY** while holding down **DISPLAY** and **M-DAX** on the main unit.
- 2** Press **INTERNET RADIO** or **ZONE2 SOURCE** to select “RC LOCK On”.
- 3** Press **STATUS** to enter the setting.
The infrared light receiving function is disabled.

❑ Enabling the remote sensor function

- 1** When the main unit is in standby mode, press **ON/STANDBY** while holding down **DISPLAY** and **M-DAX** on the main unit.
- 2** Press **INTERNET RADIO** or **ZONE2 SOURCE** to select “RC LOCK *Off”.
(* The currently set mode.)
- 3** Press **STATUS** to enter the setting.
The infrared light receiving function on the main unit is enabled.

Various memory functions

Personal memory plus function

This function sets the settings (input mode, sound mode, HDMI output mode, MultEQ®, Dynamic EQ, audio delay etc.) last selected for the individual input sources.



The surround parameters, tone control settings and the volumes of the different speakers are stored for the individual sound modes.

Last function memory

This function stores the settings which were made before going into the standby mode.

When the power is turned back on, the settings are restored.

Playback in ZONE2 (Separate room)

- You can operate this unit so as to enjoy audio in a room (ZONE2) other than the MAIN ZONE (room where the unit is located).
- You can simultaneously play back the same source in both the MAIN ZONE and ZONE2. You can also play back separate sources in the MAIN ZONE and ZONE2.

Audio output

Zone playback by speaker output

- Set the "Assign Mode" ([page 124](#)) setting to "ZONE2", and outputs ZONE2 audio from SURROUND BACK speaker terminals (The default setting is "ZONE2").
- If you set the "Assign Mode" ([page 124](#)) setting to "ZONE2", the main zone home theater system can play back up to 5.1 channels. Even if you play back audio recorded in 6.1 or 7.1 channels, this unit automatically downmixes the audio to 5.1 channels.

Connecting and setting the speakers

"Assign Mode" setting (page 124) and audio signals output	Connecting the speakers
<p>ZONE2 Output signal : Stereo (L / R)</p>	



When you connect a Blu-ray Disc player to the analog audio input terminal BD, you can listen to audio from the Blu-ray Disc player in ZONE2.

NOTE

It is not possible to play the digital audio signals input from the HDMI, COAXIAL or OPTICAL connectors in ZONE2. Play using analog connections (in stereo).

Playback

1 Press ZONE2 to switch the zone mode to the ZONE2. ZONE2 lights.

2 Press POWER to turn on the ZONE2 power.

The **Z2** indicator on the display lights.

- Also press input source select button when in standby mode, the power turns on.
- When **POWER** is pressed, ZONE2 turns off.
- Power in ZONE2 can be turned on or off by pressing **ZONE2 ON/OFF** on the main unit.

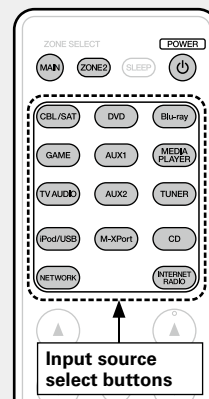

3 Press the input source select button to select the input source to be played.

The audio signal of the selected source is output to ZONE2.

- To perform an operation with the main unit, press **ZONE2 SOURCE** many times. Each time you press **ZONE2 SOURCE**, the input source changes.



When power for both MAIN ZONE and ZONE2 is set to ON, power of the MAIN ZONE only can be turned off. In Step 1, press **MAIN** and **POWER** in this order.

Adjusting the volume

Use **VOLUME** ▲▼ to adjust the volume.

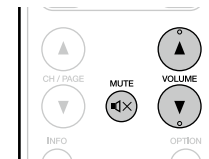

[Adjustable range] 0 – 40 – 98

(When the "Scale" ([page 112](#)) setting is "0 – 98")

[Adjustable range] --- -79dB – -40dB – 18dB

(When the "Scale" ([page 112](#)) setting is "-79.5dB – 18.0dB")

- At time of purchase, "Volume Limit" ([page 132](#)) is set to "70 (-10dB)".



Turn **VOLUME** after pressing **ZONE2 ON/OFF** on the main unit to adjust the sound volume.

Turning off the sound temporarily

Press **MUTE** ◀✕.

The sound is reduced to the level set at "Mute Level" ([page 132](#)) in the menu.

- To cancel, either adjust the volume or press **MUTE** ◀✕ again.
- The setting can also be cancelled by adjusting the volume or turning off the ZONE2 power.



You can adjust the tone and volume for ZONE2 in "ZONE2 Setup" ([page 132](#)) in the menu.

Sleep timer function

- This is convenient for viewing and listening while going to sleep in ZONE2.
- The sleep timer function can be set by zone.

1 Press **ZONE2** to switch the zone mode.
ZONE2 lights.



2 Press **SLEEP** and display the time you want to set.

- The time switches as shown below each time **SLEEP** is pressed.

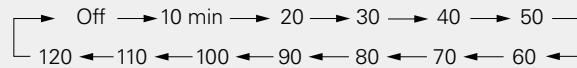

To confirm the countdown time before putting the unit to sleep

Press **SLEEP**.

"Z2 Sleep : *min" appears on the display.

* Countdown time

To cancel the sleep timer

Press **SLEEP** to set "Off".



The sleep timer is also cancelled when this unit is set to the standby mode or the ZONE2 power is turned off.

NOTE



The sleep timer function cannot turn off the power of devices connected to this unit. To turn off the power of those connected devices, set up sleep timers on the connected devices themselves.



How to make detailed settings



Menu map

For menu operation, connect a TV to this unit and display the menu on the TV screen. For menu operations, see the following page.

By default, this unit has recommended settings defined. You can customize this unit based on your existing system and your preferences.

Setting items	Detailed items	Description	Page
 Audio	Dialog Level	Sets the output level to clarify the dialogue output from the center channel.	109
	Subwoofer Level	This setting adjusts the volume level for the subwoofer.	109
	Surround Parameter	Adjusts surround sound parameters.	109
	Tone	Adjusts the tonal quality of the sound.	111
	M-DAX	Expands the low and high frequency components of compressed audio content such as MP3 files to enable richer audio playback.	111
	Audio Delay	Compensates for incorrect timing between video and audio.	112
	Volume	Set the MAIN ZONE (room where the unit is located) volume setting.	112
	Audyssey	Makes Audyssey MultEQ [®] , Audyssey Dynamic EQ [®] and Audyssey Dynamic Volume [®] settings.	112
	Graphic EQ	Uses the graphic equalizer to adjust the tone of each speaker.	113
 Video	Picture Adjust	Adjusts the video quality.	115
	HDMI Setup	Makes settings for HDMI video/audio output.	115
	Output Settings	Makes screen-related settings.	116
	On Screen Display	Select the on-screen display user interface preferences.	118
	TV Format	Set the video output signal format for the TV you are using.	118

Setting items	Detailed items	Description	Page
 Inputs	Input Assign	Changes input connector assignment.	120
	Source Rename	Changes the display name for this source.	122
	Hide Sources	Remove from the display input sources that are not used.	122
	Source Level	Adjusts the playback level of the audio input.	122
	Input Select	Sets the audio input mode and decode mode.	122
 Speakers	Audyssey[®] Setup	The acoustic characteristics of the connected speakers and listening room are measured and the optimum settings are made automatically.	22 , 91
	Manual Setup	Perform when setting the speakers manually or when changing settings made in Audyssey [®] Setup.	124
 Network	Information	Display network information.	128
	IP Control	Enables network communication in standby power mode.	128
	Friendly Name	The Friendly Name is the name of this unit displayed on the network. You can change the Friendly Name according to your preferences.	128
	Settings	Make settings for wired LAN.	129
	Diagnostics	Used to check the network connection.	130
	Maintenance Mode	Use when receiving maintenance from a Marantz service engineer or custom installer.	130

Setting items	Detailed items	Description	Page
 General	Language	Sets the language for display the menu on the TV screen.	132
	ZONE2 Setup	Makes settings for audio playback in a ZONE2 system.	132
	Zone Rename	Change the display title of each zone to one you prefer.	132
	Trigger Out	Selects when to activate trigger out .	133
	Auto Standby	When you do not perform any operation on this unit with no audio or video input for a specified time, this unit automatically enters the standby mode. Before it enters the standby mode, "Auto Standby" is displayed on the display of this unit and the menu screen.	133
	Front Display	Makes settings related to the display on this unit.	133
	Information	Show information about receiver settings, input signals, etc.	134
	Usage Data	Selects whether or not to send anonymous usage data to Marantz.	135
	Firmware	Set whether or not to check for firmware update, update the firmware, and display update and upgrade notifications.	135
Setup Lock	Protect settings from inadvertent changes.	136	
 Setup Assistant	Perform the installation, connection, and setup procedures to prepare the unit for operation following guidance from the setup section of this manual.		 7

Examples of menu screen displays

Typical examples are described below.

[Example 1]

Menu selection screen (Top menu)

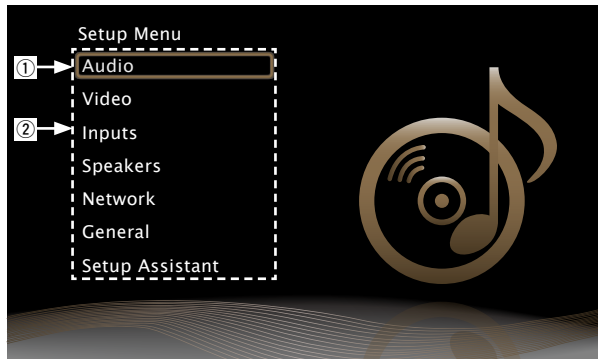

- ① Currently selected setup item
- ② List of GUI menu setup items

Use Δ / ∇ to select "Audio" and then press \triangleright .
(Or press ENTER.)

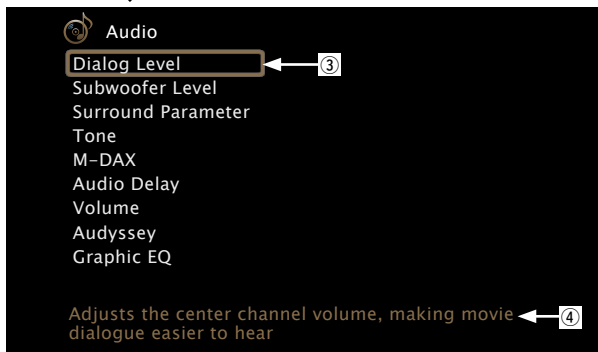
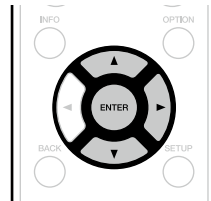

- ③ Selected setup item
- ④ Guide text for the currently selected setup item

[Example 2]

Audyssey® Setup screen (with illustration)

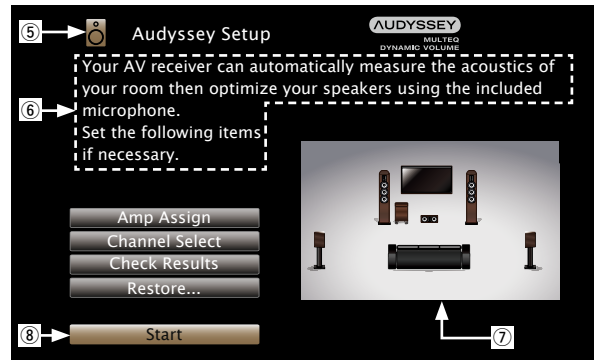

- ⑤ Currently selected setup icon
- ⑥ Operation guidance text
- ⑦ Illustration
- ⑧ Selected setup item

NOTE

When the menu is operated on a computer's resolution (e.g. VGA) or during playback of certain 3D video content, the playback image switches to the menu screen image.

Examples of menu and front display

Below we describe typical examples of displays on the TV screen and on the set's display window.

	Menu display	Front display	Description
Top menu display	<p>Setup Menu Audio ② Video Inputs Speakers Network General Setup Assistant</p>	<p>Audio ②</p>	<ol style="list-style-type: none"> 1 Press SETUP to display the menu screen. 2 TV screen: Displays the selected line. Display: Displays the selected item. <ul style="list-style-type: none"> • Use Δ/∇ to move to the item you want to set.
Display when changing settings	<p>Inputs/Input Assign Set Defaults ① HDMI DIGITAL ANALOG COMP VIDEO CBL/SAT 1 COAX 1 1 1 DVD 2 - 2 2 2 Blu-ray 3 - - - 3 GAME 4 - - - - MEDIA PLAYER 5 - - - - TV AUDIO - OPT - - - AUX1 FRONT - - - - AUX2 6 - - - -</p> <p>Press ENTER.</p> <p>Inputs/Input Assign Set Defaults ③ HDMI DIGITAL ANALOG COMP VIDEO CBL/SAT 1 COAX 1 1 1 DVD 2 - 2 2 2 Blu-ray 3 - - - 3 GAME 4 - - - - MEDIA PLAYER 5 - - - - TV AUDIO - OPT - - - AUX1 FRONT - - - - AUX2 6 - - - -</p>	<p>CBL/SAT [HDMI1] ①</p> <p>Press ENTER.</p> <p>CBL/SAT [HDMI1] ③</p>	<ol style="list-style-type: none"> 1 TV screen: Displays the selected line. Display: Displays the selected item. <ul style="list-style-type: none"> • Use Δ/∇ to move to the item you want to set. 2 Press ENTER to set to the mode in which the setting can be made. 3 \leftarrow \rightarrow is displayed at the sides of items whose setting can be changed. Use \leftarrow/\rightarrow to change to the desired setting.
Display when returning to the settings in effect at time of purchase	<p>Inputs/Input Assign Set Defaults ① HDMI DIGITAL ANALOG COMP VIDEO CBL/SAT 1 COAX 1 1 1 DVD 2 - 2 2 2 Blu-ray 3 - - - 3 GAME 4 - - - - MEDIA PLAYER 5 - - - - TV AUDIO - OPT - - - AUX1 FRONT - - - - AUX2 6 - - - -</p> <p>Press ENTER.</p> <p>Inputs/Input Assign Set Defaults ② HDMI DIGITAL ANALOG COMP VIDEO CBL/SAT 1 COAX 1 1 1 DVD 2 - 2 2 2 Blu-ray 3 - - - 3 GAME 4 - - - - MEDIA PLAYER 5 - - - - TV AUDIO - OPT - - - AUX1 FRONT - - - - AUX2 6 - - - -</p> <p>Reset all input assignments to the factory defaults? Reset Cancel</p>	<p>Default ①</p> <p>Press ENTER.</p> <p>Default? [Cancel] ②</p>	<ol style="list-style-type: none"> 1 Press Δ to select "Set Defaults" (TV screen) or "Default" (Display), then press ENTER. 2 Press \leftarrow to select "Reset", then press ENTER.

Inputting characters

On this unit, you can change the name displayed on the following screens to the names that you prefer.

- Text Search (page 64)
- Preset Name (page 43)
- Source Rename (page 122)
- Friendly Name (page 128)
- Zone Rename (page 132)
- Character input for the network functions (page 46, 54, 56, 60, 62, 129)

Keyboard screen

Select a character on the TV screen to input characters.

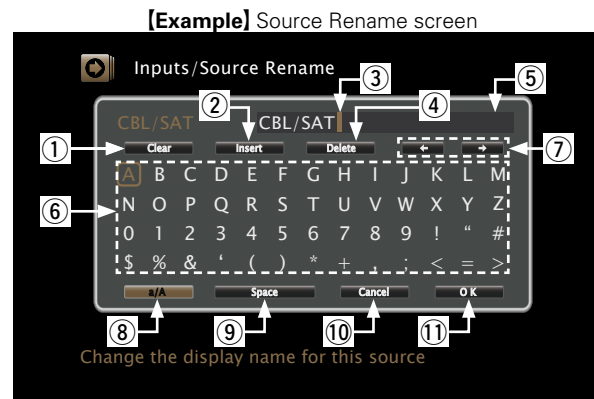

- 1 Clear key
- 2 Insert key
- 3 Cursor
- 4 Delete key
- 5 Character input section
- 6 Keyboard section
- 7 Cursor keys
- 8 Uppercase and lowercase switch key
- 9 Space key
- 10 Cancel key
- 11 OK key

Input method

1 Display the screen for inputting characters (page 103 “Menu map”).

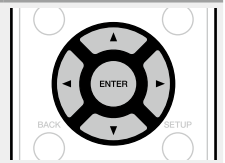

2 Select a character to be changed.

- 1 Use $\Delta \nabla \triangleleft \triangleright$ to select \leftarrow or \rightarrow .
- 2 Press **ENTER** to place the cursor at the character to be changed.
Each time **ENTER** is pressed, the cursor moves by one character.

3 Select a character to be input with $\Delta \nabla \triangleleft \triangleright$ then press **ENTER**.

- The types of characters that can be input are as shown below.

[Upper case characters/Numbers/Symbols]

ABCDEFGHIJKLMNOPQRSTUVWXYZ

0123456789

! " # \$ % & ' () * + , ; < = >

[Lower case characters/Numbers/Symbols]

abcdefghijklmnopqrstuvwxyz

0123456789

. @ - _ / : ~ ? [\] ^ ' { | }

4 Repeat steps 2 and 3 to change the name.

5 Use $\Delta \nabla \triangleleft \triangleright$ to select **OK**, then press **ENTER**.



Make audio-related settings.

Menu operation

- 1** Press **MAIN** to switch the zone mode.
MAIN lights.
- 2** Press **SETUP**.
The menu is displayed on the TV screen.
- 3** Use Δ / ∇ to select the menu to be set or operated.
- 4** Press **ENTER** or \triangleright to enter the setting.
 - To return to the previous item, press \triangleleft or **BACK**.
 - Exiting the Menu, press **SETUP** while the menu is displayed.
The menu display disappears.



Items that can be set with the "Audio" procedure

Dialog Level ([page 109](#))

Subwoofer Level ([page 109](#))

Surround Parameter ([page 109](#))

Tone ([page 111](#))

M-DAX ([page 111](#))

Audio Delay ([page 112](#))

Volume ([page 112](#))

Audyssey ([page 112](#))

Graphic EQ ([page 113](#))

Dialog Level

Default settings are underlined.

Sets the output level to clarify the dialogue output from the center channel.

Setting items	Setting details
Level	-12dB – +12dB (<u>0dB</u>)

Subwoofer Level

Default settings are underlined.

This setting adjusts the volume level for the subwoofer.

Setting items	Setting details
Subwoofer Turn subwoofer output on and off.	On : The subwoofer is used. Off : The subwoofer is not used. <div style="text-align: center;">NOTE</div> This can be set when the sound mode is "DIRECT" and "PURE DIRECT" (page 72) and the "Subwoofer Mode" (page 126) is "LFE+Main".
Subwoofer Level This setting adjusts the volume level for the subwoofer.	-12dB – +12dB (<u>0dB</u>)

Surround Parameter

Default settings are underlined.





You can adjust the surround audio sound field effects to match your preferences.

The items (parameters) that can be adjusted depend on the signal being input and the currently set sound mode. For details on the adjustable parameters, see "Sound modes and surround parameters" ([page 144](#)).

NOTE

- Some setting items cannot be set while playback is stopped. Make the settings during playback.
- When the sound mode is "PURE DIRECT", you cannot set the surround parameters.

Setting items	Setting details
Home Theater EQ Gently softens the upper treble range of movie soundtracks to reduce possible harshness and improve clarity.	On : "Home Theater EQ" is used. Off : "Home Theater EQ" is not used.
Loudness Management This can be set in the Dolby TrueHD mode. This sets whether to output as specified in "Dynamic Compression" or output directly without compressing the dynamic range of audio recorded in the disc.	On : Outputs using the settings made in "Dynamic Compression" and "Dialogue Normalization" (page 134) are enabled. Off : "Dynamic Compression" settings and "Dialogue Normalization" are disabled, and the signals on the disk are output as is.
Dynamic Compression Compress dynamic range (difference between loud and soft sounds).	Auto : Automatic dynamic range compression on/off control according to source. Low / Medium / High : These set the compression level. Off : Dynamic range compression is always off. <div style="text-align: center;"> You can set "Auto" only for the Dolby TrueHD source.</div>

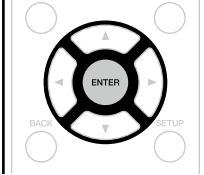

Setting items	Setting details
<p>Low Frequency Effects Adjust the low-frequency effects level (LFE).</p>	<p>-10dB – 0dB</p> <p> For proper playback of the different sources, we recommend setting to the values below.</p> <ul style="list-style-type: none"> • Dolby Digital sources : 0dB • DTS movie sources : 0dB • DTS music sources : -10dB
<p>Center Image Distributes the dialogue output from the center channel to the front left and right channels and widens the sound image in the front. You can set this when the sound mode is set to DTS NEO:6.</p>	<p>0.0 – 1.0 (0.3)</p> <p> The smaller the value, the more dialogue is concentrated on the center channel. The larger the value, the more dialogue is distributed to front left and right channels, and the more the sound image widens in the front.</p>
<p>Panorama Assign front L/R signals to also go to the surround channels for wider sound. You can set this when the sound mode is Dolby PLII in the "Music" mode.</p>	<p>On : Set. Off : Do not set.</p>
<p>Dimension Shift sound image center to front or rear to adjust playback balance. You can set this when the sound mode is Dolby PLII in the "Music" mode.</p>	<p>0 – 6 (3)</p> <p> As you set a smaller number, the surround sound field shifts backward; as you set a larger number, the surround sound field shifts forward.</p>
<p>Center Width Distributes the dialogue output from the center channel to left and right channels and widens the sound image in the front. You can set this when the sound mode is Dolby PLIIx in the "Music" mode.</p>	<p>0 – 7 (3)</p> <p> The smaller the value, the more dialogue is concentrated on the center channel. The larger the value, the more dialogue is distributed to front left and right channels, and the more the sound image widens in the front.</p>

Setting items	Setting details
<p>Height Gain Control the front height channel volume.</p>	<p>Low : Reduce the front height channel volume. Normal : Front height channel sound is output with standard sound volume. High : Increase the front height channel volume.</p> <p>NOTE</p> <p>"Height Gain" is displayed for the following settings.</p> <ul style="list-style-type: none"> • When "Assign Mode" (page 124) is set to "Front Height". • When the "Speaker Config." – "Front Height" setting (page 124) is set other than to "None". • When sound mode is "PLIIz" or the PLIIz decoder is used.
<p>Set Defaults The "Surround Parameter" settings are returned to the default settings.</p>	<p>Reset : Reset to the defaults. Cancel : Do not reset to the defaults.</p> <p> When you select "Set Defaults" and press ENTER, the "Reset all surround parameters to the factory defaults?" prompt is displayed. Select either "Reset" or "Cancel", and press ENTER.</p> 

Tone

Default settings are underlined.

Adjust the tonal quality of the sound.

Setting items	Setting details
Tone Control Set the tone control function to "On" and "Off".	<p>On : Allow tone adjustment (bass, treble). Off : Playback without tone adjustment.</p> <p> "Tone Control" can be set when "Dynamic EQ" (page 113) is set to "Off".</p> <p>NOTE</p> <ul style="list-style-type: none"> • "Tone Control" settings are not reflected to ZONE2. • The tone cannot be adjusted in the "DIRECT" and "PURE DIRECT" mode. • The default setting differs depending on the sound mode.
Bass Adjust bass.	<p>-6dB - +6dB</p> <p></p> <ul style="list-style-type: none"> • "Bass" can be set when the menu "Tone Control" setting is "On". • The default setting differs depending on the sound mode.
Treble Adjust treble.	<p>-6dB - +6dB</p> <p></p> <ul style="list-style-type: none"> • "Treble" can be set when the menu "Tone Control" setting is "On". • The default setting differs depending on the sound mode.

M-DAX

Compressed audio formats such as MP3, WMA (Windows Media Audio) and MPEG-4 AAC reduce the amount of data by eliminating signal components that are hard for the human ear to hear. The "M-DAX" function generates the signals eliminated upon compression, restoring the sound to conditions near those of the original sound before compression. It also restores the original bass characteristics for a rich and expanded tonal range.

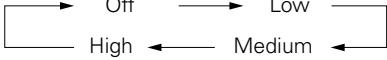
Setting items	Setting details
Mode Set the mode for "M-DAX".	<p>High : Optimized mode for compressed sources with very weak highs (64 kbps and under). Medium : Apply suitable bass and treble boost for all compressed sources (96 kbps and under). Low : Optimized mode for compressed sources with normal highs (96 kbps and over). Off : Do not use "M-DAX".</p> <p></p> <ul style="list-style-type: none"> • This item can be set with analog signals or PCM signal (Sample Rate = 44.1/48 kHz) is input. • "M-DAX" settings are stored for each input source. • When set to "Off", the M-DAX indicator on the front panel switches off. • This cannot be set when the sound mode is set to "DIRECT" or "PURE DIRECT". • This can also be set by pressing M-DAX. Each time M-DAX is pressed, the setting is changed as shown below. <div style="text-align: center;">  </div>

Audio Delay

Default settings are underlined.

While viewing video, manually adjust the time to delay audio output so that the video and audio are synchronized.

Setting details

0ms – 200ms



- This item can be set within the range of 0 to 100 ms when “Auto Lip Sync” ([page 115](#)) is set to “On” and when a TV compatible with Auto Lip Sync is connected.
- Store “Audio Delay” for each input source.
- Audio Delay for game mode can be set when “Video Mode” ([page 116](#)) is set to “Auto” or “Game”.

Volume

Default settings are underlined.

Set the MAIN ZONE (room where the unit is located) volume setting.

Setting items	Setting details
Scale Set how volume is displayed.	<u>0 – 98</u> : Display in the range 0 (Min) to 98. <u>-79.5dB – 18.0dB</u> : Display -dB (Min), in the range -79.5 dB to 18.0 dB.  <ul style="list-style-type: none"> • The “Scale” setting is applied also to the “Limit” and “Power On Level” display method. • The “Scale” setting applies to all zones.
Limit Make a setting for maximum volume.	<u>60 (-20dB) / 70 (-10dB) / 80 (0dB)</u> <u>Off</u> : Do not set a maximum volume.
Power On Level Define the volume setting that is active when the power is turned on.	<u>Last</u> : Use the memorized setting from the last session. <u>Mute</u> : Always use the muting on condition when power is turned on. <u>1 – 98 (-79dB – 18dB)</u> : The volume is adjusted to the set level.
Mute Level Set the amount of attenuation when muting is on.	<u>Full</u> : The sound is muted entirely. <u>-40dB</u> : The sound is attenuated by 40 dB down. <u>-20dB</u> : The sound is attenuated by 20 dB down.



Audyssey

Default settings are underlined.

Set Audyssey MultEQ®, Audyssey Dynamic EQ® and Audyssey Dynamic Volume®. These can be selected after Audyssey® Setup has been performed. For additional information on Audyssey technology, please see [page 150](#).



NOTE

- If you have not performed Audyssey® Setup, or if you change the speaker settings after performing Audyssey® Setup, you may not be able to select Dynamic EQ/Dynamic Volume. In this case, either perform Audyssey® Setup over again or perform “Restore...” ([page 28](#)) to return to the settings after Audyssey® Setup was run.
- When HD Audio for which the sampling frequency exceeds 96 kHz is played back, the “Audyssey” cannot be set.

Setting items	Setting details
MultEQ® MultEQ® compensates for both time and frequency characteristics of the listening area based on Audyssey® Setup measurement results. Selection is done from three types of compensation curves. We recommend the “Audyssey” setting. MultEQ® is the prerequisite function for Dynamic EQ and Dynamic Volume.	<u>Audyssey</u> : Optimize the frequency response of all speakers. <u>Audyssey Byp. L/R</u> : Optimize frequency response of speakers except front L and R speakers. <u>Audyssey Flat</u> : Optimize frequency response of all speakers to flat response. <u>Graphic EQ</u> : Apply frequency response set with “Graphic EQ” (page 113). <u>Off</u> : Turn “MultEQ®” equalizer off.
	 “Audyssey”, “Audyssey Byp. L/R” and “Audyssey Flat” can be selected after Audyssey® Setup has been performed. “Audyssey” is automatically selected after performing Audyssey® Setup. When “Audyssey”, “Audyssey Byp. L/R” or “Audyssey Flat” is selected, AUDYSSEY illuminates.
NOTE	When using headphones, “MultEQ®” is automatically set to “Off”.





“MultEQ®”, “Dynamic EQ” and “Dynamic Volume” settings are stored for each input source.

Setting items	Setting details
<p>Dynamic EQ Solves the problem of deteriorating sound quality as volume is decreased by taking into account human perception and room acoustics. Works with MultEQ®.</p>	<p>On : Use Dynamic EQ. Off : Do not use Dynamic EQ.</p> <p> AUDYSSEY is displayed when set to "On".</p> <p>NOTE When the menu "Dynamic EQ" setting is "On", it is not possible to do "Tone Control" (page 111) adjustment.</p>
<p>Reference Level Offset Audyssey Dynamic EQ® is referenced to the standard film mix level. It makes adjustments to maintain the reference response and surround envelopment when the volume is turned down from 0 dB. However, film reference level is not always used in music or other non-film content. Dynamic EQ Reference Level Offset provides three offsets from the film level reference (5 dB, 10 dB, and 15 dB) that can be selected when the mix level of the content is not within the standard. Recommended setting levels are shown at right.</p>	<p>0dB (Film Ref) : This is the default setting and should be used when listening to movies. 5dB : Select this setting for content that has a very wide dynamic range, such as classical music. 10dB : Select this setting for jazz or other music that has a wider dynamic range. This setting should also be selected for TV content as that is usually mixed at 10 dB below film reference. 15dB : Select this setting for pop/rock music or other program material that is mixed at very high listening levels and has a compressed dynamic range.</p> <p> Setting is enabled when "Dynamic EQ" is "On" (page 113).</p>
<p>Dynamic Volume Solves the problem of large variations in volume level between TV, movies and other content (between quiet passages and loud passages, etc.) by automatically adjusting to the user's preferred volume setting.</p>	<p>Heavy : Most adjustment to softest and loudest sounds. Medium : Medium adjustment to loudest and softest sound. Light : Least adjustment to loudest and softest sounds. Off : Do not use "Dynamic Volume".</p> <p> AUDYSSEY is displayed when set to "Heavy", "Medium" or "Light".</p> <ul style="list-style-type: none"> • If "Dynamic Volume" is set to "Yes" in "Audyssey® Setup" (page 26), the setting is automatically changed to "Medium".

Graphic EQ

Default settings are underlined.

Use the 9 band graphic equalizer to adjust the tone of each speaker. "Graphic EQ" can be set when "MultEQ®" setting ([page 112](#)) is "Graphic EQ".

Setting items	Setting details
<p>Speaker Selection Select whether to adjust tones for individual speakers or for all speakers.</p>	<p>All : Adjust the tone of all speakers together. Left/Right : Adjust the tone of left and right speakers together. Each : Adjust the tone of each speaker.</p>
<p>Adjust EQ Adjust tonal balance for each frequency band. Adjust the speaker selected in "Speaker Selection".</p>	<p>① Select the speaker. • Select the speakers you want to adjust when "Left/Right" or "Each" is selected. ② Select the adjustment frequency band. 63Hz / 125Hz / 250Hz / 500Hz / 1kHz / 2kHz / 4kHz / 8kHz / 16kHz ③ Adjust the level. -20.0dB - +6.0dB (0.0dB)</p>
<p>Curve Copy Copy "Audyssey Flat" (page 112) curve from MultEQ®.</p>	<p>Yes : Copy. No : Do not copy.</p> <p> "Curve Copy" is displayed after Audyssey® Setup has been performed.</p> <ul style="list-style-type: none"> • When you select "Curve Copy" and press ENTER, the "Copy "Audyssey Flat"?" prompt is displayed. Select either "Yes" or "No", and press ENTER.
<p>Set Defaults The "Graphic EQ" settings are returned to the default settings.</p>	<p>Reset : Reset to the defaults. Cancel : Do not reset to the defaults.</p> <p> When you select "Set Defaults" and press ENTER, the "Reset to the default values?" prompt is displayed. Select either "Reset" or "Cancel", and press ENTER.</p>

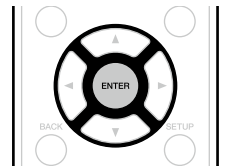



Make video-related settings.

Menu operation

- 1** Press **MAIN** to switch the zone mode.
MAIN lights.
- 2** Press **SETUP**.
The menu is displayed on the TV screen.
- 3** Use Δ / ∇ to select the menu to be set or operated.
- 4** Press **ENTER** or \triangleright to enter the setting.
 - To return to the previous item, press \triangleleft or **BACK**.
 - Exiting the Menu, press **SETUP** while the menu is displayed.
The menu display disappears.

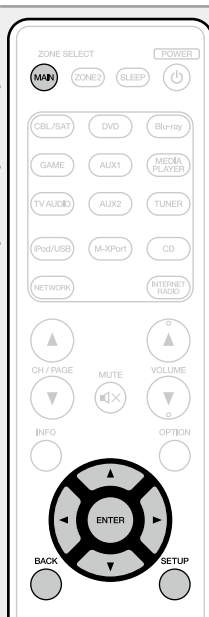

Items that can be set with the "Video" procedure

Picture Adjust ([page 115](#))

HDMI Setup ([page 115](#))

Output Settings ([page 116](#))

On Screen Display ([page 118](#))

TV Format ([page 118](#))





Picture Adjust



Default settings are underlined.

Picture quality can be adjusted.

We recommend leaving the settings unchanged from the default settings. First adjust the display image quality on your TV, and use this menu only when you want to make fine adjustments.

- This item can be set when the input source is **CBL/SAT** **DVD** **Blu-ray** **GAME** **AUX1** **AUX2** **MEDIA PLAYER** **iPod/USB** **NETWORK**.
- Can be set when the "Video Conversion" setting ([page 116](#)) is "On".
- "TV AUDIO" or "CD" can be set when "HDMI", "COMP" or "VIDEO" ([page 120](#), [121](#)) has been assigned.

Setting items	Setting details
Picture Mode Select the desired picture mode according to the video content and your viewing environment.	Standard : The standard mode suited for most living room viewing environments. Movie : A mode suited for watching movies in a dark room such as a theater room. Vivid : A mode that makes graphic images for games, etc. brighter and more vivid. Streaming : A mode suited for low bit rate video sources. Custom : Adjusts the picture quality manually. Off : No picture quality adjustment is done with this unit.  <ul style="list-style-type: none"> • You can also press OPTION to make these settings from "Picture Mode" (page 68) in the option menu. • The default settings are as follows. <ul style="list-style-type: none"> • For "NETWORK" and "iPod/USB" input sources : Streaming • For input sources other than "Network" and "iPod/USB" : Off
Contrast Adjust picture contrast.	-6 - +6 (0)  "Contrast" can be set when "Picture Mode" is set to "Custom".
Brightness Adjust picture brightness.	0 - +12  "Brightness" can be set when "Picture Mode" is set to "Custom".
Saturation Adjust picture chroma level (color saturation).	-6 - +6 (0)  "Saturation" can be set when "Picture Mode" is set to "Custom".
Hue Adjust green and red balance. Also called Tint.	-6 - +6 (0)  "Hue" can be set when "Picture Mode" is set to "Custom".

Setting items	Setting details
Noise Reduction Reduce overall video noise.	Low / Medium / High / Off  "Noise Reduction" can be set when "Picture Mode" is set to "Custom".
Enhancer Emphasize picture sharpness.	0 - +12  "Enhancer" can be set when "Picture Mode" is set to "Custom".







- "Picture Adjust" can not be set when 4K signals are input.
- "Picture Adjust" can not be set when component video and video signals are output.

HDMI Setup

Default settings are underlined.

Make settings for HDMI video/audio output.

Setting items	Setting details
Auto Lip Sync Make automatic compensation for timing shift in audio and video output.	On : Compensated. Off : Not compensated.
HDMI Audio Out Select HDMI audio output device.	AVR : Play back through speakers connected to the unit. TV : Play back through TV connected to the unit.  <ul style="list-style-type: none"> • The audio signal input from the HDMI input connector can be output as an output signal from the HDMI output connector by setting the HDMI audio output destination to TV. • When the HDMI control function is activated, priority is given to the TV audio setting (page 95 "HDMI control function"). • When the power of this unit is on and "HDMI Audio Out" is set to "TV", audio is output as 2-channel from the HDMI OUT connector.
HDMI Pass Through Selects how the AV receiver will pass HDMI signals to the HDMI output in standby power mode.	On : Passes the selected HDMI input through the AV receiver's HDMI output when the AV receiver is in standby power mode. Off : No HDMI signals are passed through the AV receiver's HDMI output in standby power mode. <div style="border: 1px solid black; border-radius: 5px; padding: 2px; display: inline-block; color: white; background-color: #e91e63; margin-top: 10px;">NOTE</div> <p>When "HDMI Pass Through" is set to "On", it consumes more standby power. If you are not using this unit for an extended period, it is recommended that you unplug the power cord from the power outlet.</p>

Setting items	Setting details
HDMI Control You can link operations with devices connected to HDMI and compatible with HDMI Control.	<p>On : Use HDMI control function. Off : Do not use HDMI control function.</p>  <ul style="list-style-type: none"> When a device that is not compatible with the HDMI control function is connected, set "HDMI Control" to "Off". Please consult the operating instructions for each connected device to check the settings. Refer to "HDMI control function" (page 95) for more information about the HDMI control function. <p>NOTE</p> <ul style="list-style-type: none"> When "HDMI Control" is set to "On", it consumes more standby power. If you are not using this unit for an extended period, it is recommended that you unplug the power cord from the power outlet. The HDMI control function controls operations of a TV that is compatible with the HDMI control function. Make sure that the TV and HDMI are connected when you perform HDMI control. If the "HDMI Control" settings have been changed, always reset the power to connected devices after the change.
Pass Through Source The AV receiver will "pass through" the sources HDMI signal when in standby.	<p>Last : Choose this option to "pass through" the last used HDMI input video source. CBL/SAT / DVD / Blu-ray / GAME / AUX1 / AUX2 / MEDIA PLAYER / CD* : Choose one of these HDMI sources to be passed through when the AV receiver is in standby. * "Pass Through Source" can be set when any of the HDMI connectors is assigned to "CD" for the input source in the "Input Assign" (page 120) setting.</p>  <p>"Pass Through Source" can be set when "HDMI Control" is set to "On" or "HDMI Pass Through" is set to "On".</p>
Power Off Control Links the power standby of this unit to external devices.	<p>All : If power to a connected TV is turned off independently of the input source, power to this unit is automatically set to standby. Video : When the TV is turned off with one of "HDMI", "COMP" or "VIDEO" (page 120, 121) assigned for the CBL/SAT / DVD / Blu-ray / GAME / AUX1 / AUX2 / MEDIA PLAYER / CD / TV AUDIO input source on this unit, power to this unit is automatically set to standby. Off : This unit does not link with power to a TV.</p>  <p>"Power Off Control" can be set when "HDMI Control" is set to "On".</p>

Output Settings



Default settings are underlined.



Makes screen-related settings.



* "CBL/SAT", "DVD", "Blu-ray", "GAME", "AUX1", "AUX2", "MEDIA PLAYER", "CD" or "TV AUDIO" can be set when "HDMI", "COMP" or "VIDEO" ([page 120, 121](#)) has been assigned.



"Output Settings" can not be set when 4K signals are input.

Setting items	Setting details										
Video Mode Make settings for video processing. <table border="1" data-bbox="1144 499 1413 671"> <tr> <td>CBL/SAT *</td> <td>DVD *</td> </tr> <tr> <td>Blu-ray *</td> <td>GAME *</td> </tr> <tr> <td>AUX1 *</td> <td>AUX2 *</td> </tr> <tr> <td colspan="2">MEDIA PLAYER *</td> </tr> <tr> <td>CD *</td> <td>TV AUDIO *</td> </tr> </table>	CBL/SAT *	DVD *	Blu-ray *	GAME *	AUX1 *	AUX2 *	MEDIA PLAYER *		CD *	TV AUDIO *	<p>Auto : Process video automatically based on the HDMI content information. Game : Always process video for game content. Movie : Always process video for movie content.</p>  <ul style="list-style-type: none"> If "Video Mode" is set to "Auto", the mode is switched according to the input contents. If a source is played in both MAIN ZONE (audio and video) and ZONE2 (audio only) modes in the same room, audio in MAIN ZONE and ZONE2 modes may sound out of synchronization, but this is not malfunction. In this case, setting to "Game" mode may improve audio synchronization.
CBL/SAT *	DVD *										
Blu-ray *	GAME *										
AUX1 *	AUX2 *										
MEDIA PLAYER *											
CD *	TV AUDIO *										
Video Conversion The input video signal is converted automatically in conjunction with the connected TV (page 6 "Converting input video signals for HD output (Video conversion function)"). <table border="1" data-bbox="1144 975 1413 1147"> <tr> <td>CBL/SAT *</td> <td>DVD *</td> </tr> <tr> <td>Blu-ray *</td> <td>GAME *</td> </tr> <tr> <td>AUX1 *</td> <td>AUX2 *</td> </tr> <tr> <td colspan="2">MEDIA PLAYER *</td> </tr> <tr> <td>CD *</td> <td>TV AUDIO *</td> </tr> </table>	CBL/SAT *	DVD *	Blu-ray *	GAME *	AUX1 *	AUX2 *	MEDIA PLAYER *		CD *	TV AUDIO *	<p>On : The input video signal is converted. Off : The input video signal is not converted.</p>  <ul style="list-style-type: none"> When a non-standard video signal from a game console or some other source is input, the video conversion function might not operate. In this case set "Video Conversion" to "Off". When "Video Conversion" is set to "Off", the video conversion function does not work.
CBL/SAT *	DVD *										
Blu-ray *	GAME *										
AUX1 *	AUX2 *										
MEDIA PLAYER *											
CD *	TV AUDIO *										

Setting items	Setting details																								
i/p Scaler Convert the input source resolution to the resolution set. <table border="1"> <tr><td>CBL/SAT</td><td>*</td><td>DVD</td><td>*</td></tr> <tr><td>Blu-ray</td><td>*</td><td>GAME</td><td>*</td></tr> <tr><td>AUX1</td><td>*</td><td>AUX2</td><td>*</td></tr> <tr><td colspan="4">MEDIA PLAYER</td></tr> <tr><td>iPod/USB</td><td></td><td>CD</td><td>*</td></tr> <tr><td>NETWORK</td><td></td><td>TV AUDIO</td><td>*</td></tr> </table>	CBL/SAT	*	DVD	*	Blu-ray	*	GAME	*	AUX1	*	AUX2	*	MEDIA PLAYER				iPod/USB		CD	*	NETWORK		TV AUDIO	*	<input type="checkbox"/> When the input source is set other than "iPod/USB" and "NETWORK" Analog : Use i/p (interlace-to-progressive) scaler function for analog video signals. Analog & HDMI : Use i/p scaler function for analog and HDMI video signals. HDMI : Use i/p scaler function for HDMI video signals. Off : Do not use i/p scaler function. <input type="checkbox"/> When the input source is set to "iPod/USB" and "NETWORK" On : Use i/p scaler function. Off : Do not use i/p scaler function.  <ul style="list-style-type: none"> • "Analog & HDMI" can be set for input sources for which an HDMI input connector is assigned. • Which items can be set depend on the input source assigned to each input connector. • This function is not effective when the input signal is "x.v.Color", 3D, sYCC 601 color, Adobe RGB color, Adobe YCC 601 color or computer resolutions.
CBL/SAT	*	DVD	*																						
Blu-ray	*	GAME	*																						
AUX1	*	AUX2	*																						
MEDIA PLAYER																									
iPod/USB		CD	*																						
NETWORK		TV AUDIO	*																						
Resolution Set the output resolution. You can set "Resolution" separately for HDMI output of the analog video input and HDMI input. <table border="1"> <tr><td>CBL/SAT</td><td>*</td><td>DVD</td><td>*</td></tr> <tr><td>Blu-ray</td><td>*</td><td>GAME</td><td>*</td></tr> <tr><td>AUX1</td><td>*</td><td>AUX2</td><td>*</td></tr> <tr><td colspan="4">MEDIA PLAYER</td></tr> <tr><td>iPod/USB</td><td></td><td>CD</td><td>*</td></tr> <tr><td>NETWORK</td><td></td><td>TV AUDIO</td><td>*</td></tr> </table>	CBL/SAT	*	DVD	*	Blu-ray	*	GAME	*	AUX1	*	AUX2	*	MEDIA PLAYER				iPod/USB		CD	*	NETWORK		TV AUDIO	*	Auto : The number of pixels the TV connected to the HDMI MONITOR OUT connector supports is detected automatically and the appropriate output resolution is set. 480p/576p / 1080i / 720p / 1080p / 1080p:24Hz / 4K : Set the output resolution.  <ul style="list-style-type: none"> • This item can be set when "i/p Scaler" is set to anything other than "Off". • When "i/p Scaler" is set to "Analog & HDMI", the resolution of both the analog video input signal and HDMI input signal can be set. • To watch 1080p/24Hz pictures, use a TV that supports 1080p/24Hz video signals. • When set to "1080p:24Hz", you can enjoy film-like pictures for film sources (in 24 Hz). For video sources and mixed sources, we recommend setting the resolution to "1080p". • It is not possible to convert a 50 Hz signal into 1080p/24Hz. It is output at a resolution of 1080p/50Hz.
CBL/SAT	*	DVD	*																						
Blu-ray	*	GAME	*																						
AUX1	*	AUX2	*																						
MEDIA PLAYER																									
iPod/USB		CD	*																						
NETWORK		TV AUDIO	*																						

Setting items	Setting details																								
Progressive Mode Set an appropriate progressive conversion mode for the source video signal. <table border="1"> <tr><td>CBL/SAT</td><td>*</td><td>DVD</td><td>*</td></tr> <tr><td>Blu-ray</td><td>*</td><td>GAME</td><td>*</td></tr> <tr><td>AUX1</td><td>*</td><td>AUX2</td><td>*</td></tr> <tr><td colspan="4">MEDIA PLAYER</td></tr> <tr><td>CD</td><td>*</td><td>TV AUDIO</td><td>*</td></tr> </table>	CBL/SAT	*	DVD	*	Blu-ray	*	GAME	*	AUX1	*	AUX2	*	MEDIA PLAYER				CD	*	TV AUDIO	*	Auto : The video signal is automatically detected and the appropriate mode is set. Video : Select mode suitable for video playback. Video and Film : Select mode suitable for video and 30-frame film material playback.  This item can be set when "i/p Scaler" is set to anything other than "Off".				
CBL/SAT	*	DVD	*																						
Blu-ray	*	GAME	*																						
AUX1	*	AUX2	*																						
MEDIA PLAYER																									
CD	*	TV AUDIO	*																						
Aspect Ratio Set the aspect ratio for the video signals output to the HDMI. <table border="1"> <tr><td>CBL/SAT</td><td>*</td><td>DVD</td><td>*</td></tr> <tr><td>Blu-ray</td><td>*</td><td>GAME</td><td>*</td></tr> <tr><td>AUX1</td><td>*</td><td>AUX2</td><td>*</td></tr> <tr><td colspan="4">MEDIA PLAYER</td></tr> <tr><td>iPod/USB</td><td></td><td>CD</td><td>*</td></tr> <tr><td>NETWORK</td><td></td><td>TV AUDIO</td><td>*</td></tr> </table>	CBL/SAT	*	DVD	*	Blu-ray	*	GAME	*	AUX1	*	AUX2	*	MEDIA PLAYER				iPod/USB		CD	*	NETWORK		TV AUDIO	*	16:9 : Output at 16:9 aspect ratio. 4:3 : Output at 4:3 aspect ratio with black bars on the sides of a 16:9 TV screen (except for 480p/576p output).  "Aspect Ratio" can be set when "i/p Scaler" is set to anything other than "Off".
CBL/SAT	*	DVD	*																						
Blu-ray	*	GAME	*																						
AUX1	*	AUX2	*																						
MEDIA PLAYER																									
iPod/USB		CD	*																						
NETWORK		TV AUDIO	*																						

* "CBL/SAT", "DVD", "Blu-ray", "GAME", "AUX1", "AUX2", "MEDIA PLAYER", "CD" or "TV AUDIO" can be set when "HDMI", "COMP" or "VIDEO" ([page 120](#), [121](#)) has been assigned.

On Screen Display

Default settings are underlined.

Select the on-screen display user interface preferences.

Setting items	Setting details
Volume Sets where to display the master volume level.	<u>Bottom</u> : Display at the bottom. <u>Top</u> : Display at the top. <u>Off</u> : Turn display off.  When the master volume display is hard to see when superimposed text (closed captioning) or movie subtitles are present, set to "Top".
Info Displays status of operation temporarily when the sound mode is changed, or input source is switched. You can set whether or not to show each of these status displays.	<u>On</u> : Turn display on. <u>Off</u> : Turn display off.
Now Playing Sets how long each menu is displayed when the input source is "NETWORK", "iPod/USB", or "TUNER".	<u>Always On</u> : Show display continuously. <u>Auto Off</u> : Show display for 30 seconds after operation.

TV Format

Default settings are underlined.

Set the video signal format to be output for the TV you are using.

Setting items	Setting details
Format	<u>NTSC</u> : Select NTSC output. <u>PAL</u> : Select PAL output.  "Format" can also be set by the following procedure. However, the menu screen is not displayed. <ol style="list-style-type: none"> 1. Press and hold the main unit's ZONE2 SOURCE and STATUS for at least 3 seconds. "V.Format:<NTSC>" appears on the display. 2. Use the main unit's ZONE2 SOURCE or INTERNET RADIO and set the video signal format. 3. Press the main unit's STATUS to complete the setting. <div style="background-color: #f08080; border-radius: 5px; padding: 2px; display: inline-block; margin-top: 10px;">NOTE</div> When a format other than the video format of the connected TV is set, the picture will not be displayed properly.



Perform settings related to input source playback.

- You do not have to change the settings to use the unit. Make settings when needed.

Menu operation

1 Press **MAIN** to switch the zone mode.
MAIN lights.

2 Press **SETUP**.
The menu is displayed on the TV screen.

3 Use Δ / ∇ to select the menu to be set or operated.

4 Press **ENTER** or \blacktriangleright to enter the setting.

- To return to the previous item, press \blacktriangleleft or **BACK**.
- Exiting the Menu, press **SETUP** while the menu is displayed.
The menu display disappears.



Items that can be set with the "Inputs" procedure

Input Assign ([page 120](#))

Source Rename ([page 122](#))

Hide Sources ([page 122](#))

Source Level ([page 122](#))

Input Select ([page 122](#))

Important information

□ About the display of input sources

In this section, the configurable input sources for each item are shown as follows.

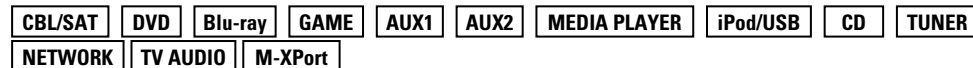

NOTE

Input sources that have been set to "Hide" at "Hide Sources" ([page 122](#)) cannot be selected.

Input Assign

This unit has certain input sources such as "CBL/SAT" assigned to audio and video connectors by default. By making the default connections, you can simply press an input source select button to play back audio or video from the connected device with ease.

When making connections other than the default settings, you must change settings in this section.

Examples of "Input Assign" menu screen displays

This screen appears when the "Inputs" – "each input source" – "Input Assign" menu is selected. Use the "Input Assign" menu to change the ② HDMI input connectors, ③ Digital input connectors, ④ Analog input connectors, ⑤ Component input connectors, and ⑥ Video input connectors that are assigned to the ① input sources in default settings.

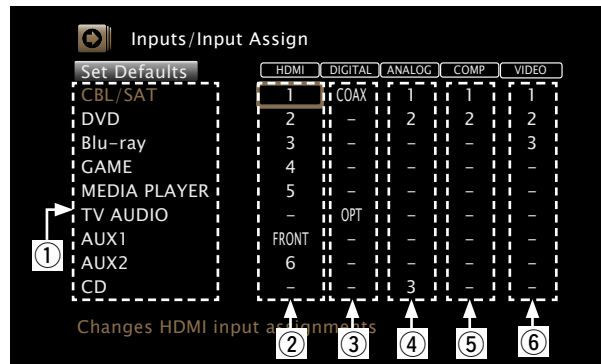

Input assignments menu operations

- 1** Use Δ ∇ \triangleleft \triangleright to move the cursor to the item you want to set, and then press **ENTER**.
- 2** Use \triangleleft \triangleright to select the input connector to be assigned.
- 3** Press **ENTER** to register the setting.

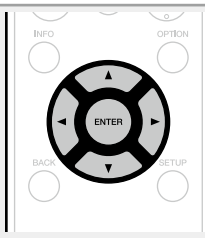

TV set top box/satellite users please note

When using the optical or coaxial digital audio output on a TV/satellite box

To play the video signal assigned to "HDMI" combined with the audio signal assigned at "Input Assign" – "DIGITAL", you will also need to select "Digital" in the "Input Mode" ([page 122](#)).

Setting items	Setting details																										
HDMI Set this to change the HDMI input connectors assigned to the input sources.	1 / 2 / 3 / 4 / 5 / 6 / FRONT : Assign an HDMI input connector to the selected input source. – : Do not assign an HDMI input connector to the selected input source.																										
<table border="1"> <tr><td>CBL/SAT</td><td>DVD</td></tr> <tr><td>Blu-ray</td><td>GAME</td></tr> <tr><td>AUX1</td><td>AUX2</td></tr> <tr><td colspan="2">MEDIA PLAYER</td></tr> <tr><td>CD</td><td>TV AUDIO</td></tr> </table>	CBL/SAT	DVD	Blu-ray	GAME	AUX1	AUX2	MEDIA PLAYER		CD	TV AUDIO	<ul style="list-style-type: none"> At time of purchase, the settings of the different input sources are as shown below. <table border="1"> <thead> <tr> <th>Input source</th> <th>CBL/SAT</th> <th>DVD</th> <th>Blu-ray</th> <th>GAME</th> <th>AUX1</th> </tr> </thead> <tbody> <tr> <td>Default setting</td> <td>1</td> <td>2</td> <td>3</td> <td>4</td> <td>FRONT</td> </tr> </tbody> </table>					Input source	CBL/SAT	DVD	Blu-ray	GAME	AUX1	Default setting	1	2	3	4	FRONT
CBL/SAT	DVD																										
Blu-ray	GAME																										
AUX1	AUX2																										
MEDIA PLAYER																											
CD	TV AUDIO																										
Input source	CBL/SAT	DVD	Blu-ray	GAME	AUX1																						
Default setting	1	2	3	4	FRONT																						
	<table border="1"> <thead> <tr> <th>Input source</th> <th>AUX2</th> <th>MEDIA PLAYER</th> <th>CD</th> <th>TV AUDIO</th> </tr> </thead> <tbody> <tr> <td>Default setting</td> <td>6</td> <td>5</td> <td>–</td> <td>–</td> </tr> </tbody> </table>					Input source	AUX2	MEDIA PLAYER	CD	TV AUDIO	Default setting	6	5	–	–												
Input source	AUX2	MEDIA PLAYER	CD	TV AUDIO																							
Default setting	6	5	–	–																							
	<ul style="list-style-type: none"> To play the video signal assigned at "HDMI" combined with the audio signal assigned at "Input Assign" – "DIGITAL", select "Digital" at "Input Mode" (page 122). When "HDMI Control" (page 116) is set to "On", HDMI input connector cannot be assigned to "TV AUDIO". 																										

Setting items	Setting details																						
DIGITAL Set this to change the digital audio input connectors assigned to the input sources.	COAX (Coaxial) / OPT (Optical) : Assign a digital input connector to the selected input source. – : Do not assign a digital input connector to the selected input source. <ul style="list-style-type: none"> At time of purchase, the settings of the different input sources are as shown below. <table border="1"> <thead> <tr> <th>Input source</th> <th>CBL/SAT</th> <th>DVD</th> <th>Blu-ray</th> <th>GAME</th> <th>AUX1</th> </tr> </thead> <tbody> <tr> <td>Default setting</td> <td>COAX</td> <td>–</td> <td>–</td> <td>–</td> <td>–</td> </tr> </tbody> </table> <table border="1"> <thead> <tr> <th>Input source</th> <th>AUX2</th> <th>MEDIA PLAYER</th> <th>CD</th> <th>TV AUDIO</th> </tr> </thead> <tbody> <tr> <td>Default setting</td> <td>–</td> <td>–</td> <td>–</td> <td>OPT</td> </tr> </tbody> </table>	Input source	CBL/SAT	DVD	Blu-ray	GAME	AUX1	Default setting	COAX	–	–	–	–	Input source	AUX2	MEDIA PLAYER	CD	TV AUDIO	Default setting	–	–	–	OPT
Input source	CBL/SAT	DVD	Blu-ray	GAME	AUX1																		
Default setting	COAX	–	–	–	–																		
Input source	AUX2	MEDIA PLAYER	CD	TV AUDIO																			
Default setting	–	–	–	OPT																			
ANALOG Set this to change the analog audio input connectors assigned to the input sources.	1 / 2 / 3 : Assign a analog input connector to the selected input source. – : Do not assign a analog input connector to the selected input source. <ul style="list-style-type: none"> At time of purchase, the settings of the different input sources are as shown below. <table border="1"> <thead> <tr> <th>Input source</th> <th>CBL/SAT</th> <th>DVD</th> <th>Blu-ray</th> <th>GAME</th> <th>AUX1</th> </tr> </thead> <tbody> <tr> <td>Default setting</td> <td>1</td> <td>2</td> <td>–</td> <td>–</td> <td>–</td> </tr> </tbody> </table> <table border="1"> <thead> <tr> <th>Input source</th> <th>AUX2</th> <th>MEDIA PLAYER</th> <th>CD</th> <th>TV AUDIO</th> </tr> </thead> <tbody> <tr> <td>Default setting</td> <td>–</td> <td>–</td> <td>3</td> <td>–</td> </tr> </tbody> </table>	Input source	CBL/SAT	DVD	Blu-ray	GAME	AUX1	Default setting	1	2	–	–	–	Input source	AUX2	MEDIA PLAYER	CD	TV AUDIO	Default setting	–	–	3	–
Input source	CBL/SAT	DVD	Blu-ray	GAME	AUX1																		
Default setting	1	2	–	–	–																		
Input source	AUX2	MEDIA PLAYER	CD	TV AUDIO																			
Default setting	–	–	3	–																			

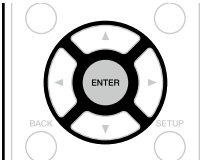
Setting items	Setting details																						
COMP (Component video) Set this to change the component video input connectors assigned to the input sources.	1 / 2 : Assign the component video input connector to the selected input source. – : Do not assign a component video input connector to the selected input source. <ul style="list-style-type: none"> At time of purchase, the settings of the different input sources are as shown below. <table border="1"> <thead> <tr> <th>Input source</th> <th>CBL/SAT</th> <th>DVD</th> <th>Blu-ray</th> <th>GAME</th> <th>AUX1</th> </tr> </thead> <tbody> <tr> <td>Default setting</td> <td>1</td> <td>2</td> <td>–</td> <td>–</td> <td>–</td> </tr> </tbody> </table> <table border="1"> <thead> <tr> <th>Input source</th> <th>AUX2</th> <th>MEDIA PLAYER</th> <th>CD</th> <th>TV AUDIO</th> </tr> </thead> <tbody> <tr> <td>Default setting</td> <td>–</td> <td>–</td> <td>–</td> <td>–</td> </tr> </tbody> </table>	Input source	CBL/SAT	DVD	Blu-ray	GAME	AUX1	Default setting	1	2	–	–	–	Input source	AUX2	MEDIA PLAYER	CD	TV AUDIO	Default setting	–	–	–	–
Input source	CBL/SAT	DVD	Blu-ray	GAME	AUX1																		
Default setting	1	2	–	–	–																		
Input source	AUX2	MEDIA PLAYER	CD	TV AUDIO																			
Default setting	–	–	–	–																			
VIDEO Set this to change the composite video input connectors assigned to the input sources.	1 / 2 / 3 : Assign the video input connector to the selected input source. – : Do not assign a video input connector to the selected input source. <ul style="list-style-type: none"> At time of purchase, the settings of the different input sources are as shown below. <table border="1"> <thead> <tr> <th>Input source</th> <th>CBL/SAT</th> <th>DVD</th> <th>Blu-ray</th> <th>GAME</th> <th>AUX1</th> </tr> </thead> <tbody> <tr> <td>Default setting</td> <td>1</td> <td>2</td> <td>3</td> <td>–</td> <td>–</td> </tr> </tbody> </table> <table border="1"> <thead> <tr> <th>Input source</th> <th>AUX2</th> <th>MEDIA PLAYER</th> <th>CD</th> <th>TV AUDIO</th> </tr> </thead> <tbody> <tr> <td>Default setting</td> <td>–</td> <td>–</td> <td>–</td> <td>–</td> </tr> </tbody> </table>	Input source	CBL/SAT	DVD	Blu-ray	GAME	AUX1	Default setting	1	2	3	–	–	Input source	AUX2	MEDIA PLAYER	CD	TV AUDIO	Default setting	–	–	–	–
Input source	CBL/SAT	DVD	Blu-ray	GAME	AUX1																		
Default setting	1	2	3	–	–																		
Input source	AUX2	MEDIA PLAYER	CD	TV AUDIO																			
Default setting	–	–	–	–																			
Set Defaults The “Input Assign” settings are returned to the default settings.	Reset : Reset to the defaults. Cancel : Do not reset to the defaults. <ul style="list-style-type: none"> If you select “Set Defaults” and press ENTER, the message “Reset all input assignments to the factory default?” is displayed. Select “Reset” or “Cancel”, and then press ENTER. 																						

Source Rename

Change the display name of the selected input source.

This is convenient when the input source name of your device and the input source name of this unit are different. You can change the name to suit your needs. When the renaming is completed, the name is displayed on this unit's display and on the menu screen.

Setting details

CBL/SAT / DVD / Blu-ray / GAME / AUX1 / AUX2 / MEDIA PLAYER / CD / TV AUDIO / M-XPort :

Change the display name of the selected input source.

- Up to 12 characters can be input.
- For character input, see [page 107](#).

Set Defaults : The "Source Rename" settings are returned to the default settings.

- **Reset :** Reset to the defaults.
- **Cancel :** Do not reset to the defaults.

 If you select "Set Defaults" and press **ENTER**, the message "Reset all source names to the factory defaults?" is displayed. Select "Reset" or "Cancel", and then press **ENTER**.

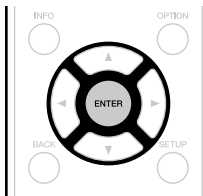

Hide Sources

Default settings are underlined.

Remove from the display input sources that are not used.

Setting details

CBL/SAT / DVD / Blu-ray / GAME / AUX1 / AUX2 / MEDIA PLAYER / iPod/USB / CD / TUNER / Favorites / Internet Radio / Media Server / Pandora / SiriusXM / Spotify / Flickr / TV AUDIO / M-XPort : Select input source that is not used.

- **Show :** Use this source.
- **Hide :** Do not use this source.

NOTE

- Input sources being used in the MAIN ZONE or ZONE2 cannot be selected.
- Input sources being used in the various zones cannot be deleted.
- Input sources set to "Hide" cannot be selected using the input source select button.

Source Level

Default settings are underlined.

- This function corrects the playback level of the selected input source's audio input.
- Make this setting if there are differences in the input volume levels between the different sources.

Setting details



-12dB – +12dB (0dB)

Input Select

Default settings are underlined.

Set the audio input mode and decode mode of each input source.

The input modes available for selection may vary depending on the input source.

Setting items	Setting details										
Input Mode Set the audio input modes for the different input sources. It is normally recommended to set the audio input mode to "Auto".	Auto : Automatically detect input signal and perform playback. HDMI : Play only signals from HDMI input. Digital : Play only signals from digital input. Analog : Play only signals from analog input.  <ul style="list-style-type: none"> • "Digital" can be set for input sources for which "DIGITAL" is assigned at "Input Assign" (page 121). • When digital signals are properly input, the DIG. indicator lights on the display. If the DIG. indicator does not light, check "Input Assign" (page 121) and the connections. • If "HDMI Control" is set to "On" and a TV compatible with the ARC is connected via the HDMI MONITOR connectors, the input mode whose input source is "TV AUDIO" is fixed to ARC. 										
Decode Mode Set the audio decode mode for input source.	Auto : Detect type of digital input signal and decode and play automatically. PCM : Decode and play only PCM input signals. DTS : Decode and play only DTS input signals.  <ul style="list-style-type: none"> • This item can be set for input sources for which "DIGITAL" is assigned at "Input Assign" (page 121). • Normally set this mode to "Auto". Set "PCM" and "DTS" when inputting the corresponding input signal. 										
<table border="1"> <tbody> <tr> <td>CBL/SAT</td> <td>DVD</td> </tr> <tr> <td>Blu-ray</td> <td>GAME</td> </tr> <tr> <td>AUX1</td> <td>AUX2</td> </tr> <tr> <td colspan="2">MEDIA PLAYER</td> </tr> <tr> <td>CD</td> <td>TV AUDIO</td> </tr> </tbody> </table>	CBL/SAT	DVD	Blu-ray	GAME	AUX1	AUX2	MEDIA PLAYER		CD	TV AUDIO	
CBL/SAT	DVD										
Blu-ray	GAME										
AUX1	AUX2										
MEDIA PLAYER											
CD	TV AUDIO										



Set when changing Audyssey® Setup settings.

- If you change the speaker settings after performing Audyssey® Setup, it will not be possible to set Audyssey MultEQ®, Audyssey Dynamic EQ® and Audyssey Dynamic Volume® (☞ [page 112, 113](#)).
- Can be used without changing the settings. Please set if necessary.

Menu operation

1 Press **MAIN** to switch the zone mode.
MAIN lights.

2 Press **SETUP**.
The menu is displayed on the TV screen.

3 Use Δ / ∇ to select the menu to be set or operated.

4 Press **ENTER** or \blacktriangleright to enter the setting.

- To return to the previous item, press \blacktriangleleft or **BACK**.
- Exiting the Menu, press **SETUP** while the menu is displayed.
The menu display disappears.

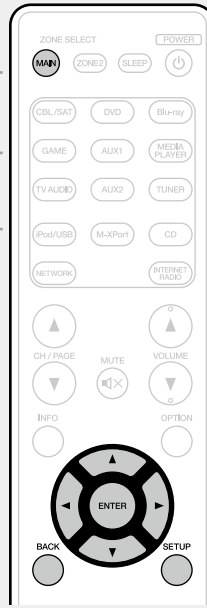

Items that can be set with the “Speakers” procedure

Audyssey® Setup (☞ [page 22, 91](#))



Manual Setup (☞ [page 124](#))

Manual Setup



Default settings are underlined.



Perform when setting the speakers manually or when changing settings made in Audyssey® Setup.

- If you change the speaker settings after performing Audyssey® Setup, it will not be possible to select Audyssey MultEQ®, Audyssey Dynamic EQ® and Audyssey Dynamic Volume® ([page 112, 113](#)).
- “Manual Setup” can be used without changing the settings. Please set if necessary.

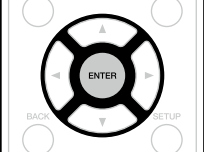
Setting items	Setting details
Amp Assign Select power amplifier usage method to match your speaker system.	Assign Mode : Set the assignment mode. <ul style="list-style-type: none"> • Surround Back : Setting for 7.1-channel playback using surround back speakers. • ZONE2 : Setting to assign the unit’s built-in power amplifier for ZONE2 and output the audio in stereo. • Bi-AMP : Setting to use the front speakers via the bi-amp connection. • Front B : Setting to use the second set of front speakers for playback. You can switch the front speakers A and B to be used for playback in accordance with the 2-channel playback or multi-channel playback mode. When you select this Front B setting, also perform the “Front Speaker” (page 126) procedure. • Front Height : Setting for 7.1-channel playback using front height speakers.
Speaker Config. Indicate speaker presence and select speaker size categories based on bass reproduction capability. <p>NOTE</p> Do not use the outward shape of the speaker to determine selection of a “Large” or “Small” speaker. Instead, use the frequencies set in “Crossovers” (page 126) as the standard for determining bass reproduction capability.	Front : Set the front speaker size. <ul style="list-style-type: none"> • Large : Use a large speaker that can adequately play back very low bass frequencies. • Small : Use a small speaker that has inadequate playback capacity for very low bass frequencies. Note that for most multi-channel speakers, this is the best choice. <p> When “Subwoofer” is set to “No”, “Front” is automatically set to “Large”.</p> <p>When “Front” is set to “Small”, “Center”, “Surround”, “Surr. Back” and “Front Height” can not be set to “Large”.</p> <hr/> Center : Set the presence and size of the center speaker. <ul style="list-style-type: none"> • Large : Use a large speaker that can adequately play back very low bass frequencies. • Small : Use a small speaker that has inadequate playback capacity for very low bass frequencies. Note that this is almost always the best choice. • None : Select when a center speaker is not connected. <p> “Large” is not displayed when “Front” is set to “Small”.</p> <hr/> Subwoofer : Set the presence of a subwoofer. <ul style="list-style-type: none"> • Yes : Use a subwoofer. • No : Select when a subwoofer is not connected. <p> When “Front” is set to “Small”, “Subwoofer” is automatically set to “Yes”.</p>

Setting items	Setting details
Speaker Config. (Continued)	Surround : Set the presence and size of the surround speakers. <ul style="list-style-type: none"> • Large : Use a large speaker that can adequately play back very low bass frequencies. • Small : Use a small speaker that has inadequate playback capacity for very low bass frequencies. Note that this is almost always the best choice. • None : Select when the surround speakers are not connected. <p></p> <ul style="list-style-type: none"> • When “Surround” is set to “Large”, “Surr. Back” and “Front Height” can be set to “Large”. • When “Surround” is set to “None”, “Surr. Back” and “Front Height” are automatically set to “None”. <hr/> Surr. Back : Set the presence, size and number of surround back speakers. <ul style="list-style-type: none"> • Large : Use a large speaker that can adequately play back very low bass frequencies. • Small : Use a small speaker that has inadequate playback capacity for very low bass frequencies. Note that this is almost always the best choice. • None : Select when the surround back speakers are not connected. <ul style="list-style-type: none"> • 2spkrs : Use two surround back speakers. • 1spkr : Use only one surround back speaker. When you select this setting, connect the surround back speaker to the left (L) channel. <p>NOTE</p> When “Assign Mode” setting (page 124) is “Surround Back”, you can make the “Surr. Back” setting.
	<hr/> Front Height : Set the presence and size of the front height speakers. <ul style="list-style-type: none"> • Large : Use a large speaker that can adequately play back very low bass frequencies. • Small : Use a small speaker that has inadequate playback capacity for very low bass frequencies. Note that this is almost always the best choice. • None : Select when the front height speakers are not connected. <p>NOTE</p> When “Assign Mode” setting (page 124) is “Front Height”, you can make the “Front Height” setting.

Setting items	Setting details
Distances Set distance from listening position to speakers. Measure beforehand the distance from the listening position to each speaker.	<p>Unit : Set the unit of distance.</p> <ul style="list-style-type: none"> • Feet / Meters <p>Step : Set the minimum variable width of the distance.</p> <ul style="list-style-type: none"> • 1ft / 0.1ft • 0.1m / 0.01m <p>Set Defaults : The “Distances” settings are returned to the default settings.</p> <ul style="list-style-type: none"> • Reset : Reset to the defaults. • Cancel : Do not reset to the defaults. <p> When you select “Set Defaults” and press ENTER, the “Resets all of the distance settings to the factory defaults?” prompt is displayed. Select either “Reset” or “Cancel”, and press ENTER.</p>  <p>Front L / Front R / F. Height L / F. Height R / Center / Subwoofer / Surround L / Surround R / Surr. Back L* / Surr. Back R* : Select speaker for distance setting.</p> <p>* When the “Speaker Config.” – “Surr. Back” setting (page 124) is set to “1spkr”, “Surr. Back” is displayed.</p> <ul style="list-style-type: none"> • 0.0ft – 60.0ft / 0.00m – 18.00m : Set the distance. <p> The speakers that can be selected differ depending on the “Amp Assign” (page 124) and “Speaker Config.” (page 124) settings.</p> <ul style="list-style-type: none"> • Default settings : Front L / Front R / F. Height L / F. Height R / Center / Subwoofer : 12.0 ft (3.60 m) Surround L / Surround R / Surr. Back L / Surr. Back R : 10.0 ft (3.00 m) • Set the difference in the distance between the speakers to less than 20.0 ft (6.00 m). <p>NOTE “Distances” cannot be set for speakers with “Speaker Config.” (page 124) set to “None”.</p>

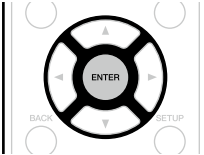
Setting items	Setting details
Levels Set the volume of the test tone to be the same when it is output from each speaker.	<p>Test Tone Start : Output test tone.</p> <ul style="list-style-type: none"> • Front L / F. Height L / Center / F. Height R / Front R / Surround R / Surr. Back R* / Surr. Back L* / Surround L / Subwoofer : A test tone is output from the selected speaker. While listening to the test tone, adjust the volume output from the selected speaker. * When the “Speaker Config.” – “Surr. Back” setting (page 124) is set to “1spkr”, “Surr. Back” is displayed. • -12.0dB – +12.0dB (0.0dB) : Adjust the volume. <p> When “Levels” is adjusted, the adjusted values are set for all the sound modes.</p> <p>NOTE</p> <ul style="list-style-type: none"> • “Levels” cannot be set for speakers with “Speaker Config.” (page 124) set to “None”. • When headphones are connected to the PHONES connector on this unit, you cannot set “Levels”. <p>Set Defaults : The “Levels” settings are returned to the default settings.</p> <ul style="list-style-type: none"> • Reset : Reset to the defaults. • Cancel : Do not reset to the defaults. <p> When you select “Set Defaults” and press ENTER, the “Reset all of the channel level settings to the factory defaults?” prompt is displayed. Select either “Reset” or “Cancel”, and press ENTER.</p> 

Setting items	Setting details
Crossovers Set the maximum frequency of the bass signal output from each channel to the subwoofer. Set the Crossover Frequency to suit the bass reproduction capability of the speaker being used.	<p>Speaker Selection : Selects how to set the crossover frequency. See the speaker manual for information concerning speaker crossover frequency.</p> <ul style="list-style-type: none"> • All : Selects the crossover point of all speakers at the same time. • Individual : Selects the crossover points for each speaker individually. <p>The following settings can be set when the "Speaker Selection" setting is set to "Individual".</p> <ul style="list-style-type: none"> • Front / Center / Surround / Surr. Back / Front Height : Select speaker for setting of crossover frequency. • 40Hz / 60Hz / 80Hz / 90Hz / 100Hz / 110Hz / 120Hz / 150Hz / 200Hz / 250Hz : Set the crossover frequency. <p></p> <ul style="list-style-type: none"> • "Crossovers" can be set when the "Bass" – "Subwoofer Mode" (page 126) setting is "LFE+Main", or when you have a speaker that is set to "Small". • The default crossover frequency is "80Hz", which will work best with the widest variety of speakers. When using very small speakers, however, you can choose a higher setting based on the specified frequency response of the speakers. If the speaker has a specified frequency response of 120 Hz – 20 kHz (as an example), then choose the 120 Hz crossover frequency. • For speakers set to "Small", low frequency content below the crossover frequency is attenuated to the speakers and the low bass content is then re-delivered to the subwoofer, or the front (L/R) speakers if they have been set to Large. • The speakers that can be set when "Individual" is selected differ depending on to the "Subwoofer Mode" setting (page 126). <ul style="list-style-type: none"> • When "LFE" is selected, speakers set to "Small" at "Speaker Config." can be set. If the speakers are set to "Large", "Full Band" is displayed and the setting cannot be made. • If set to "LFE+Main", this setting can be made regardless of the speaker size.

Setting items	Setting details
Bass Set subwoofer and LFE signal range playback.	<p>Subwoofer Mode : Select low range signals to be reproduced by subwoofer.</p> <ul style="list-style-type: none"> • LFE : The low range signal of the channel set to "Small" speaker size is added to the LFE signal output from the subwoofer. • LFE+Main : The low range signal of all channels is added to the LFE signal output from the subwoofer. This is usually the best setting for most systems. <p></p> <ul style="list-style-type: none"> • "Subwoofer Mode" can be set when "Speaker Config." – "Subwoofer" (page 124) is set to other than "No". • Play music or a movie source and select the mode offering the strongest bass. • Select "LFE+Main" if you want the bass signals to always be produced from the subwoofer. <p>NOTE</p> <p>If "Front" and "Center" for "Speaker Config." are set to "Large", and "Subwoofer Mode" is set to "LFE", no sound may be output from the subwoofers, depending on the input signal or selected sound mode.</p> <p>LPF for LFE : Set LFE signal playback range. Set this when you want to change the playback frequency (low pass filter point) of the subwoofer.</p> <ul style="list-style-type: none"> • 80Hz / 90Hz / 100Hz / 110Hz / 120Hz / 150Hz / 200Hz / 250Hz
Front Speaker Set the front speakers to use.	<p>A : Front speaker A is used. B : Front speaker B is used. A+B : Both front speakers A and B are used.</p> <p>NOTE</p> <p>This can be set when "Assign Mode" is set to "Front B" (page 124).</p>



To use this unit by connecting it to a home network (LAN), you must configure network settings. If you set up your home network (LAN) via DHCP, set "DHCP" to "On" (use the default setting). This allows this unit to use your home network (LAN).

If you assign an IP address for each device, you must use the "IP Address" setting to assign an IP address to this unit and enter the information about your home network (LAN) such as the gateway address and subnet mask.

Menu operation

1 Press **MAIN** to switch the zone mode.
MAIN lights.

2 Press **SETUP**.
The menu is displayed on the TV screen.

3 Use Δ / ∇ to select the menu to be set or operated.

4 Press **ENTER** or \blacktriangleright to enter the setting.

- To return to the previous item, press \blacktriangleleft or **BACK**.
- Exiting the Menu, press **SETUP** while the menu is displayed.
The menu display disappears.

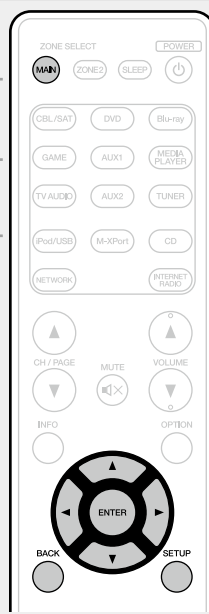

Items that can be set with the "Network" procedure

Information (👉 page 128)

IP Control (👉 page 128)

Friendly Name (👉 page 128)

Settings (👉 page 129)

Diagnostics (👉 page 130)

Maintenance Mode (👉 page 130)

Information

Display network information.

Setting details

Friendly Name / DHCP On or Off / IP Address / MAC Address

 MAC Address is required to make a vTuner account.

IP Control

Default settings are underlined.

Enables network communication in standby power mode.

Setting details

Off In Standby : Suspend network function during standby.

Always On : Network is on during standby. Main unit operable with a network compatible controller.

 Set to "Always On" when using the web control function.

NOTE

When "IP Control" is set to "Always On", it consumes more standby power.

Friendly Name

The Friendly Name is the name of this unit displayed on the network. You can change the Friendly Name according to your preferences.

Setting items

Edit Name

Edits Friendly Name.

Set Defaults

Restores Friendly Name, which you had changed, to the default setting.

Setting details

- The default Friendly Name on first use is "Marantz NR1604".
- Up to 63 characters can be input.
- For character input, see [page 107](#).

Reset : Reset to the defaults.

Cancel : Do not reset to the defaults.

 When you select "Set Defaults" and press **ENTER**, the "Reset the friendly name back to the factory default?" prompt is displayed. Select either "Reset" or "Cancel", and press **ENTER**.

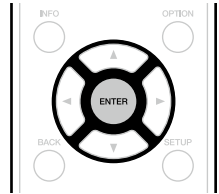

Settings

Make settings for wired LAN.

Only set "Settings" when connecting to a network without a DHCP function.

Setting details

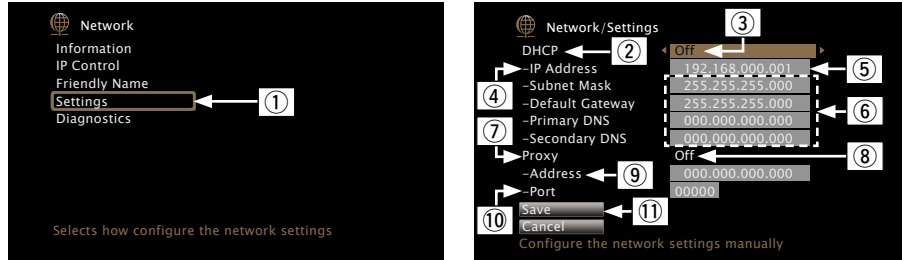

① On the menu, select "Network" – "Settings" and press **ENTER**.

② Use $\Delta \nabla$ to select "DHCP", then press **ENTER**.

③ Use $\triangleleft \triangleright$ to select "Off", then press **ENTER**.

④ Use $\Delta \nabla$ to select "IP Address", then press **ENTER**.

• **IP Address** : Set the IP address within the ranges shown below.

The Network Audio function cannot be used if other IP addresses are set.

CLASS A: 10.0.0.1 – 10.255.255.254

CLASS B: 172.16.0.1 – 172.31.255.254

CLASS C: 192.168.0.1 – 192.168.255.254

⑤ Use $\Delta \nabla \triangleleft \triangleright$ to input the address and press **ENTER**.

⑥ Use $\Delta \nabla$ to select setting item, then press **ENTER**.

• **Subnet Mask** : When connecting an xDSL modem or terminal adapter directly to this unit, input the subnet mask indicated in the documentation supplied by your provider. Normally input 255.255.255.0.

• **Default Gateway** : When connected to a gateway (router), input its IP address.

• **Primary DNS, Secondary DNS** : If there is only one DNS address indicated in the documentation supplied by your provider, input it at "Primary DNS". If two or more DNS are provided by your provider, enter both "Primary DNS" and "Secondary DNS".

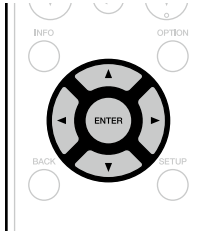

Setting details

⑦ Use $\Delta \nabla$ to select "Proxy" and press **ENTER**.

• **Proxy** : Make this setting when connecting to the Internet via a proxy server.

Make the proxy settings only when you connect to the Internet via a proxy server that is on your internal network or provided by your provider, etc.

⑧ Use $\triangleleft \triangleright$ to select "On(Address)" or "On(Name)", and then press **ENTER**.

On(Address) : Select when inputting by address.

On(Name) : Select when inputting by domain name. Up to 38 characters can be input.

⑨ Press ∇ to select "Address" or "Name", then press **ENTER**.

When "Address" is selected in step ⑧ : Use $\Delta \nabla \triangleleft \triangleright$ to enter the proxy server address, and press **ENTER**.

When "Name" is selected in step ⑧ : Use the software keyboard ([page 107](#)) to enter the domain name, and select **OK**.

• For character input, see [page 107](#).

⑩ Press ∇ to select "Port", then press **ENTER**. Use $\Delta \nabla \triangleleft \triangleright$ to input the proxy server port number and press **ENTER**.

Setup is complete.

⑪ Press ∇ to select "Save", then press **ENTER**.

The display returns to the original screen.



- If you are using a broadband router (DHCP function), there is no need to make the settings at "IP Address" and "Proxy", since the DHCP function is set to "On" in this unit's default settings.
- If this unit is connected to a network without the DHCP function, the network settings must be made. In this case, some knowledge of networks is required. For details, consult a network administrator.
- If you cannot connect to the Internet, recheck the connections and settings ([page 20](#)).
- If you do not understand about Internet connection, contact your ISP (Internet Service Provider) or the store from which you purchased your computer.
- When you want to cancel the setting during IP address input, select "Cancel", then press **ENTER**.

Diagnostics

Used to check the network connection.

Setting items	Setting details
Physical Connection Checks the physical LAN port connection.	OK : Connected. Error : The LAN cable is not connected. Check the connection.
Router Access Checks the connection from this unit to the router.	OK : Accessed. Error : Failed to communicate with the router. Check the router settings.
Internet Access Checks whether this unit has access to the Internet (WAN).	OK : Connected. Error : Failed to connect to the Internet. Check the Internet connection environment or router settings.

Maintenance Mode

Use when receiving maintenance from a Marantz service engineer or custom installer. Ordinarily, this mode isn't suitable for use by the end user, only by a trained service technician or custom installation professional.

Setting details

NOTE

Only use this function if so instructed by a Marantz serviceperson or installer.



Make various other settings.

Menu operation

- 1** Press **MAIN** to switch the zone mode.
MAIN lights.
- 2** Press **SETUP**.
The menu is displayed on the TV screen.
- 3** Use Δ / ∇ to select the menu to be set or operated.
- 4** Press **ENTER** or \triangleright to enter the setting.
 - To return to the previous item, press \triangleleft or **BACK**.
 - Exiting the Menu, press **SETUP** while the menu is displayed.
The menu display disappears.



Items that can be set with the "General" procedure

Language (👉 page 132)

ZONE2 Setup (👉 page 132)

Zone Rename (👉 page 132)

Trigger Out (👉 page 133)

Auto Standby (👉 page 133)

Front Display (👉 page 133)

Information (👉 page 134)

Usage Data (👉 page 135)

Firmware (👉 page 135)

Setup Lock (👉 page 136)

Language

Default settings are underlined.

Set the language for display on the menu screen.

Setting details

English / Français / Español



"Language" can also be set by the following procedure. However, the menu screen is not displayed. Following the display content to make the setting.

1. Press and hold the main unit's **ZONE2 SOURCE** and **STATUS** for at least 3 seconds.
"V.Format:<NTSC>" appears on the display.
2. Press the main unit's **DISPLAY** and set "Lang.:<ENGLISH >".
3. Use the main unit's **ZONE2 SOURCE** or **INTERNET RADIO** and set the language.
4. Press the main unit's **STATUS** to complete the setting.

ZONE2 Setup

Default settings are underlined.

Set the audio to play back with multi-zone (ZONE2).

Setting items	Setting details
Lch Level Adjust the left channel output level.	-12dB – +12dB (0dB)
Rch Level Adjust the right channel output level.	-12dB – +12dB (0dB)
Volume Level Set the volume output level.	Variable : Volume adjustment is enabled by main unit and remote control unit. 1 – 98 (-79dB – 18dB) : The volume is adjusted to the set level.
Volume Limit Make a setting for maximum volume.	60 (-20dB) / 70 (-10dB) / 80 (0dB) Off : Do not set a maximum volume. This is displayed from -79 dB to 18 dB when "Scale" (page 112) is set to "-79.5dB – 18.0dB".

Setting items	Setting details
Power On Volume Define the volume setting that is active when the power is turned on.	Last : Use the memorized setting from the last session. Mute : Always mute when power is turned on. 1 – 98 (-79dB – 18dB) : The volume is adjusted to the set level. This is displayed from -79 dB to 18 dB when "Scale" (page 112) is set to "-79.5dB – 18.0dB".
Mute Level Set the amount of attenuation when muting is on.	Full : The sound is muted entirely. -40dB : The sound is attenuated by 40 dB down. -20dB : The sound is attenuated by 20 dB down.

Zone Rename

Change the display title of each zone to one you prefer.

Setting details

MAIN ZONE / ZONE2

- Up to 10 characters can be input.
- For character input, see [page 107](#).

Set Defaults : The input source name is returned to the default setting.

- **Reset** : Reset to the defaults.
- **Cancel** : Do not reset to the defaults.



If you select "Set Defaults" and press **ENTER**, the message "Reset all zone names to the factory defaults?" is displayed. Select "Reset" or "Cancel", and then press **ENTER**.

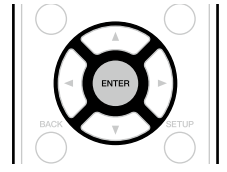

Trigger Out

Selects when to activate trigger out.

For details about how to connect the DC OUT jacks, see “DC OUT jack” (page 94).

Setting details

When setting for zone (MAIN ZONE / ZONE2)

Trigger out is activated through linkage to the power of the zone set to “On”.

When setting for input source

Activate trigger out when the input source set to “On” is selected.

 Active for the zone set to “On” with “When setting for zone”.

- **On** : Activate trigger on this mode.
- **---** : Do not activate trigger on this mode.

Auto Standby

Default settings are underlined.

When you do not perform any operation on this unit with no audio or video input for a specified time, this unit automatically enters the standby mode. Before it enters the standby mode, “Auto Standby” is displayed on the display of this unit and the menu screen.

Setting details

60 min : The unit goes into standby after 60 minutes.

30 min : The unit goes into standby after 30 minutes.

Off : The unit does not go into standby automatically.

Front Display

Default settings are underlined.

Adjust the display brightness of this unit.

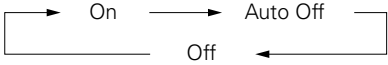
Setting items	Setting details
Display	<p>On : Display is always on.</p> <p>Auto Off : Display is off except when showing the status display.</p> <p>Off : Display is always off.</p> <p> Buttons on the main unit can be used for operations. Each time DISPLAY is pressed, the setting is changed as shown below.</p> <div style="text-align: center;">  </div> <p>NOTE</p> <p>When “Display” is set to “Off”, the display turns off and appears as if there is no electricity.</p>

Information

Show information about receiver settings, input signals, etc.

Items	Setting details				
Audio Show information about audio input signals.	<p>Sound Mode : The currently set surround mode. Input Signal : The input signal type. Format : The number of input signal channels (presence of front, surround, LFE). Sample Rate : The input signal's sampling frequency. Offset : The dialogue normalization correction value. Flag : This is displayed when inputting signals including a surround back channel. "MATRIX" is displayed with Dolby Digital EX and DTS-ES Matrix signals, "DISCRETE" with DTS-ES Discrete signals.</p> <table border="1" style="width: 100%;"> <thead> <tr> <th style="text-align: center;">Dialogue normalization function</th> </tr> </thead> <tbody> <tr> <td> This function is automatically activated when playing Dolby Digital, Dolby Digital Plus, Dolby TrueHD, DTS and DTS-HD sources. It automatically corrects the standard signal level for individual program sources. The correction value can be checked using the STATUS on the main unit. </td> </tr> <tr> <td style="text-align: center;"> <div style="border: 1px solid black; padding: 5px; width: fit-content; margin: 0 auto;">Offset: - 4dB</div> </td> </tr> <tr> <td> The figure is the corrected value. This cannot be changed. </td> </tr> </tbody> </table>	Dialogue normalization function	This function is automatically activated when playing Dolby Digital, Dolby Digital Plus, Dolby TrueHD, DTS and DTS-HD sources. It automatically corrects the standard signal level for individual program sources. The correction value can be checked using the STATUS on the main unit.	<div style="border: 1px solid black; padding: 5px; width: fit-content; margin: 0 auto;">Offset: - 4dB</div>	The figure is the corrected value. This cannot be changed.
Dialogue normalization function					
This function is automatically activated when playing Dolby Digital, Dolby Digital Plus, Dolby TrueHD, DTS and DTS-HD sources. It automatically corrects the standard signal level for individual program sources. The correction value can be checked using the STATUS on the main unit.					
<div style="border: 1px solid black; padding: 5px; width: fit-content; margin: 0 auto;">Offset: - 4dB</div>					
The figure is the corrected value. This cannot be changed.					
Video Show information about HDMI input/output signals and HDMI monitors.	<p>HDMI Signal Info.</p> <ul style="list-style-type: none"> • Resolution / Color Space / Pixel Depth <p>HDMI Monitor</p> <ul style="list-style-type: none"> • Interface / Resolutions 				
ZONE Show information about current settings.	<p>MAIN ZONE : This item shows information about settings for MAIN ZONE. The information displayed differs according to the input source.</p> <ul style="list-style-type: none"> • ZONE Name / Select Source / Name / Sound Mode / Input Mode / Decode Mode / HDMI / Digital / Analog / Component / Video / Video Select / Video Mode / Content Type / Video Conversion / i/p Scaler / Resolution / Progressive Mode / Aspect Ratio etc. <p>ZONE2 : This item shows information about settings for ZONE2.</p> <ul style="list-style-type: none"> • ZONE Name / Power / Select Source / Volume Level 				
Firmware	<p>Version : Displays information for the current firmware.</p>				
Notifications Selects notification message preferences.	<p>Notification Alerts</p> <ul style="list-style-type: none"> • On : Displays notification messages from Marantz in the popup menu. • Off : Does not display notification messages from Marantz in the popup menu. 				



Press **INFO** to display current source name, volume, sound mode name, and other information at the bottom of the screen.

Examples of screen display

- Status display screen
 When the input source is switched.

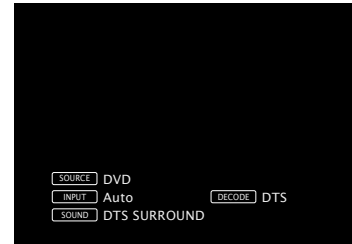

When the volume is adjusted.

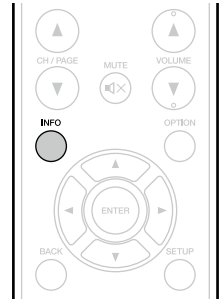
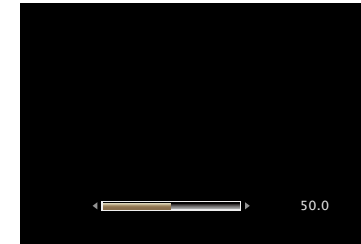

Status display: The operating status appears briefly on the screen when the input source is switched or the volume is changed.

NOTE

The status display screen cannot be displayed at a computer's resolution (e.g. VGA) or while certain 3D video contents is being played.

Usage Data

To help us improve our products and customer service, Marantz collects anonymous information about how you use your AV receiver (such as frequently used input sources and sound modes and speaker settings). Marantz will never provide any information we collect to third parties.

Setting details





Yes : Provide Marantz with information about how you use this unit via the network.

No : Do not provide Marantz with information about how you use this unit via the network.

Firmware

Set whether or not to check for firmware update, update the firmware, and display update and upgrade notifications.

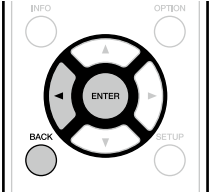
Setting items	Setting details												
<p>Update Update the firmware of the receiver.</p> <p>NOTE In cases where it is not possible to connect to the network after doing a firmware update, connect to the network again using "Network" (page 127).</p>	<p>Check for Update : Check for firmware updates. You can also check approximately how long it will take to complete an update.</p> <p>Update Start : Execute the update process.</p> <p>When updating starts, the power indicator becomes red and the menu screen is shut down. The amount of update time which has elapsed is displayed.</p> <ul style="list-style-type: none"> If updating fails, the set automatically retries, but if updating is still not possible, one of the messages shown below is displayed. If the display reads as shown below, check the settings and network environment, then update again. <table border="1"> <thead> <tr> <th>Display</th> <th>Description</th> </tr> </thead> <tbody> <tr> <td>Updating fail</td> <td>Updating failed.</td> </tr> <tr> <td>Login failed</td> <td>Failure to log into server.</td> </tr> <tr> <td>Server is busy</td> <td>Server is busy. Wait a while then try again.</td> </tr> <tr> <td>Connection fail</td> <td>Failure in connecting to server.</td> </tr> <tr> <td>Download fail</td> <td>Downloading of the firmware has failed.</td> </tr> </tbody> </table>	Display	Description	Updating fail	Updating failed.	Login failed	Failure to log into server.	Server is busy	Server is busy. Wait a while then try again.	Connection fail	Failure in connecting to server.	Download fail	Downloading of the firmware has failed.
Display	Description												
Updating fail	Updating failed.												
Login failed	Failure to log into server.												
Server is busy	Server is busy. Wait a while then try again.												
Connection fail	Failure in connecting to server.												
Download fail	Downloading of the firmware has failed.												

Setting items	Setting details
<p>Notifications Displays a notification message on this unit's menu screen when the latest firmware is released with "Update". Display a notification message on this unit's menu screen when downloadable firmware is released with "Add New Feature".</p>	<p>Update : The notification message is displayed for about 20 seconds when the power is turned on. Connect to broadband Internet (page 20) when using this function.</p> <ul style="list-style-type: none"> On : Display update message. Off : Do not display update message. <p> When you press ENTER during display of the notification message, the "Check for Update" screen is displayed (Refer to page 135 for more information on "Update").</p> <p> Press BACK to erase the notification message.</p>  <p>Upgrade : The notification message is displayed for about 20 seconds when the power is turned on. Connect to broadband Internet (page 20) when using this function.</p> <ul style="list-style-type: none"> On : Display upgrade message. Off : Do not display upgrade message. <p> When you press ENTER during display of the notification message, the "Add New Feature" screen is displayed (Refer to page 136 for more information on "Add New Feature").</p> <ul style="list-style-type: none"> Press STATUS or SOUND MODE to erase the notification message.

Setting items	Setting details
<p>Add New Feature Display new features that can be downloaded to this unit and perform an upgrade.</p> <p>NOTE In cases where it is not possible to connect to the network after adding a new function, connect to the network again using "Network" (page 127).</p>	<p>Upgrade Package : Display the items to be upgraded. Upgrade Status : Display a list of the additional functions provided by the upgrade. Upgrade Start : Execute the upgrade process. When the upgrade starts, the power indicator becomes red and the menu screen is shut down. During the upgrade, the amount of upgrade time which has elapsed is displayed.</p> <ul style="list-style-type: none"> • If the upgrade is not successful, an error message identical to those in "Update" will appear on the display. Check the settings and network environment and then perform the upgrade again. <p> See the Marantz website for details about upgrades. When the procedure is complete, "Registered" is displayed in this menu and upgrades can be carried out. If the procedure has not been carried out, "Not Registered" is displayed. The ID number shown on this screen is needed when carrying out the procedure. The ID number can also be displayed by pressing and holding the main unit's STATUS and SOUND MODE for at least 3 seconds.</p>

Notes concerning use of "Update" and "Add New Feature"
<ul style="list-style-type: none"> • In order to use these functions, you must have the correct system requirements and settings for a broadband Internet connection (page 20). • Do not turn off the power until updating or upgrading is completed. • Even with a broadband connection to the Internet, approximately 1 hour is required for the updating/upgrading procedure to be completed. • Once updating/upgrade starts, normal operations on this unit cannot be performed until updating/upgrading is completed. Furthermore, there may be cases where backup data is reset for the parameters, etc., set on this unit. • If the update or upgrade fails, press and hold the  on the main unit for more than 5 seconds, or remove and re-insert the power cord. "Update retry" appears on the display and update restarts from the point at which update failed. If the error continues despite this, check the network environment.



- Information regarding the "Update" function and "Add New Feature" will be announced on the Marantz web site each time related plans are defined.
- When usable new firmware is released with "Update" or "Add New Feature", a notification message is displayed on the menu screen. When you do not want to be notified, set "Notifications" – "Update" ([page 135](#)) and "Notifications" – "Upgrade" ([page 135](#)) to "Off".

Setup Lock





Default settings are underlined.

Protect settings from inadvertent changes.

Setting items	Setting details
Lock	<p>On : Turn protection on. Off : Turn protection off.</p> <p> When cancelling the setting, set "Lock" to "Off".</p> <p>NOTE When "Lock" is set to "On", the settings listed below can no longer be changed. Also, "Setup Locked!" is displayed if you attempt to operate related settings.</p> <ul style="list-style-type: none"> • Setup menu operations

Information

Here we list other information related to this unit.
Please refer to this information as needed.

- Part names and functions  [page 138](#)
- Other information  [page 143](#)
- Troubleshooting  [page 153](#)
- Specifications  [page 158](#)
- Index  [page 159](#)

Part names and functions

Front panel

For buttons not explained here, see the page indicated in parentheses ().

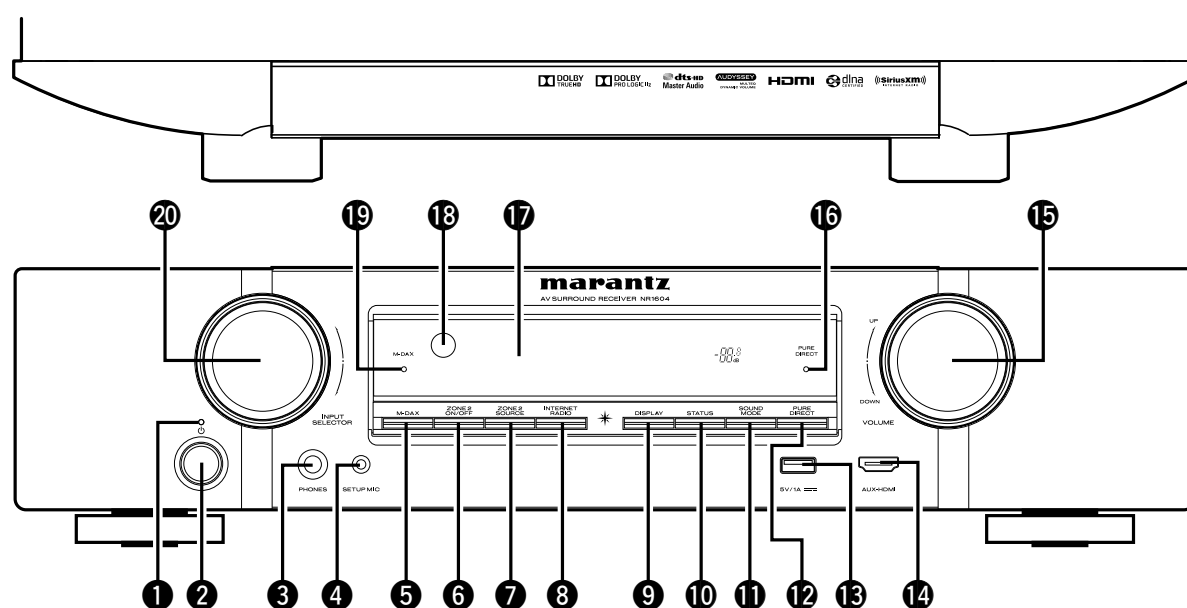

- | | | |
|--|---|--|
| <p>1 Power indicator (29)</p> <p>[Power indicator status]</p> <ul style="list-style-type: none"> • Power on : Off • Normal standby : Red • When “HDMI Pass Through” or “HDMI Control” (page 116) is set to “On” : Orange • When “IP Control” (page 128) is set to “Always On” : Orange <p>2 Power operation button (b) (29)</p> <p>Turns power to this unit on and off (standby).</p> | <p>3 Headphones jack (PHONES)</p> <p>When the headphones are plugged into this jack, audio will no longer be output from the connected speakers.</p> <p>NOTE</p> <p>To prevent hearing loss, do not raise the volume level excessively when using headphones.</p> <p>4 SETUP MIC jack (23, 91)</p> <p>5 M-DAX button (111)</p> <p>6 ZONE2 ON/OFF button (101)</p> <p>7 ZONE2 SOURCE button (101)</p> <p>8 INTERNET RADIO button (47)</p> | <p>9 DISPLAY button (133)</p> <p>10 STATUS button (32, 47, 51, 63, 134)</p> <p>11 SOUND MODE button (72)</p> <p>12 PURE DIRECT button (73)</p> <p>13 USB port (16, 35)</p> <p>14 AUX-HDMI connector (10)</p> <p>15 VOLUME knob (30, 101)</p> <p>16 PURE DIRECT indicator (73)</p> <p>17 Display (139)</p> <p>18 Remote control sensor (142)</p> <p>19 M-DAX indicator (111)</p> <p>20 INPUT SELECTOR knob (29)</p> |
|--|---|--|

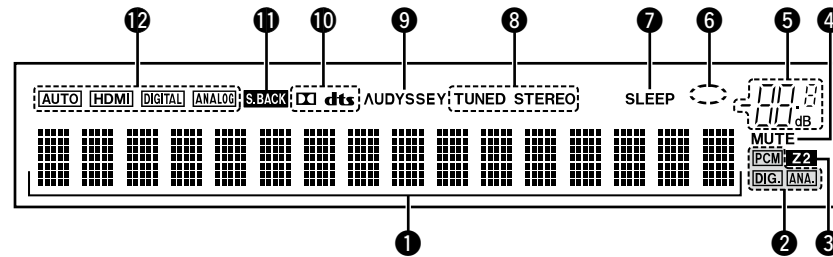

1 Information display

The input source name, sound mode, setting values and other information are displayed here.

2 Input signal indicators

3 MULTI ZONE indicators

This lights up when ZONE2 (separate room) power is turned on ([page 101](#)).

4 MUTE indicator

This lights when the audio mute mode is selected ([page 30](#)).

5 Master volume indicator

6 Circle indicator

Circle indicator is displayed when the input source is "NETWORK" or "iPod/USB" when you are playing back music.

7 Sleep timer indicator

This lights when the sleep mode is selected ([page 96](#)).

8 Tuner reception mode indicators

These light according to the reception conditions when the input source is set to "TUNER".

STEREO : In FM mode, this lights up when receiving stereo broadcasts.

TUNED : Lights up when the broadcast is properly tuned in.

9 Audyssey® indicator

This indicator lights when the "MultEQ®" ([page 112](#)), "Dynamic EQ" ([page 113](#)) or "Dynamic Volume" ([page 113](#)) setting is set to other than "Off".

10 Decoder indicator

These light when Dolby or DTS signals are input or when the Dolby or DTS decoder is running.

11 Surround back indicator

This lights when audio signals are being output from the surround back speakers ([page 124](#)).

12 Input mode indicators

Set the audio input modes for the different input sources ([page 122](#)).

Rear panel

See the page indicated in parentheses ().

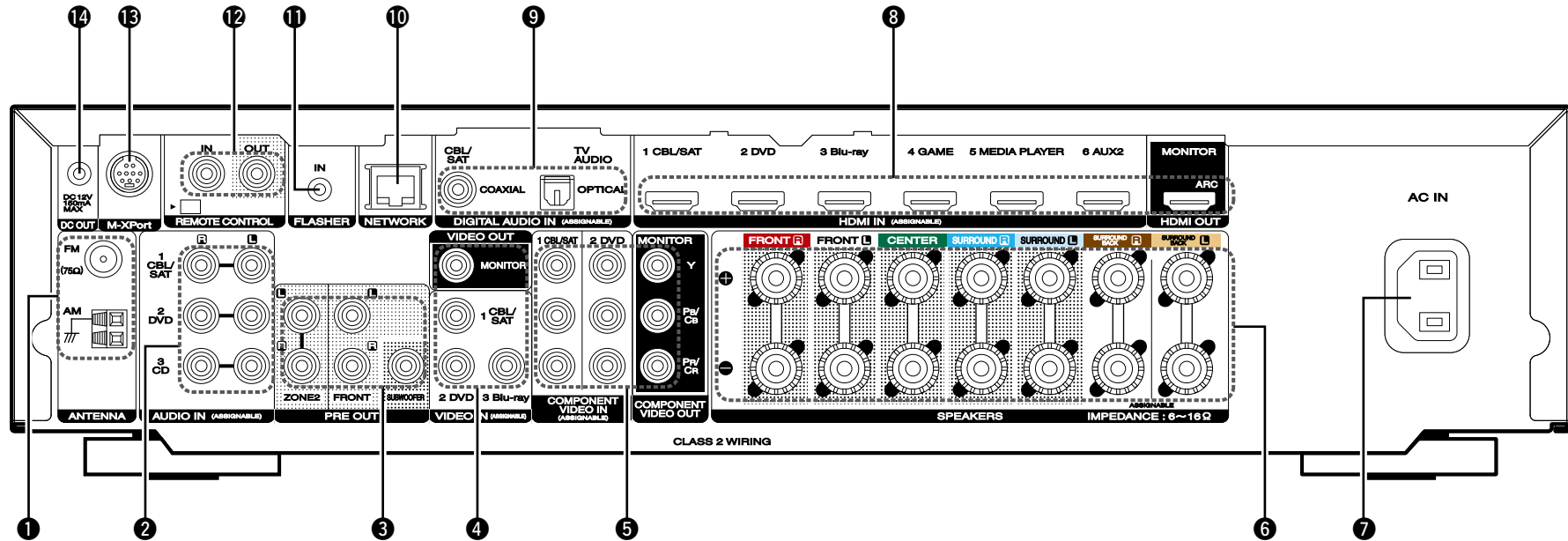

- ① FM/AM antenna terminals (ANTENNA) (18)
- ② Analog audio connectors (AUDIO) (14, 15, 17)
- ③ PRE OUT connectors (83, 84, 85, 86, 87, 88, 89, 90)
- ④ Video connectors (VIDEO) (13, 14, 15)
- ⑤ Component video connectors (COMPONENT VIDEO) (13, 14, 15)
- ⑥ Speaker terminals (SPEAKERS) (83, 84, 85, 86, 87, 88, 89, 90, 101)
- ⑦ AC inlet (AC IN) (21)
- ⑧ HDMI connectors (9, 10)
- ⑨ Digital audio connectors (DIGITAL AUDIO) (13, 14)
- ⑩ Network connector (NETWORK) (20)
- ⑪ FLASHER IN jack
Used when using a control BOX or other such control devices to control this unit.
- ⑫ REMOTE CONTROL connectors (93)
- ⑬ M-XPort connector (19)
- ⑭ DC OUT connector (94)

NOTE

Do not touch the inner pins of the connectors on the rear panel. Electrostatic discharge may cause permanent damage to the unit.

Remote control unit

For buttons not explained here, see the page indicated in parentheses ().

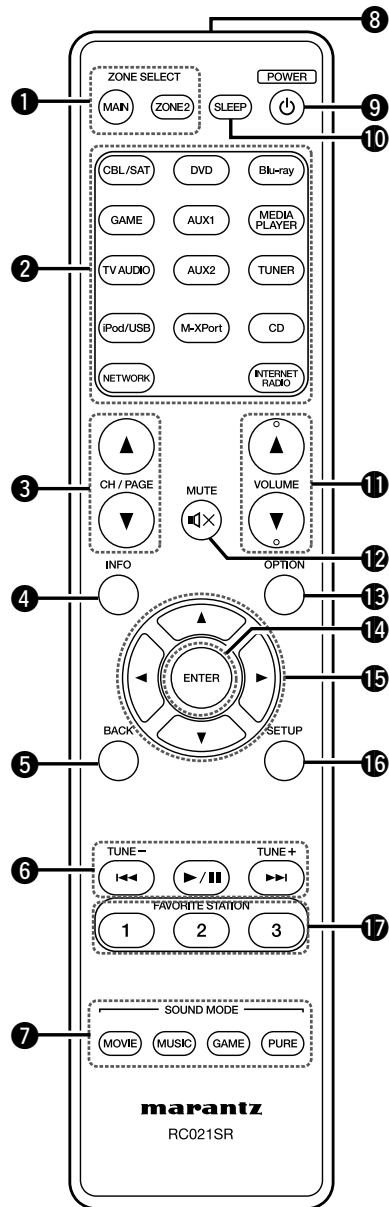

- 1** ZONE SELECT buttons
(MAIN, ZONE2) (23, 69, 91, 101, 142)
- 2** Input source select buttons (29, 101)
- 3** Channel/page search buttons
(CH/PAGE ▲▼)
..... (33, 36, 40, 45, 48, 52, 55, 59, 61, 63)
- 4** MUTE button (MUTE) (30, 101)
- 5** Information button (INFO) (134)
- 6** Cursor buttons (▲▼◀▶)
..... (106, 108, 114, 119, 123, 127, 131)
- 7** BACK button
..... (35, 47, 51, 54, 60, 63)
- 8** System buttons (33, 36, 52, 59)
 - Skip buttons (I◀◀, ▶▶I)
 - Play/pause button (▶/II)
- Tuning up / Tuning down buttons**
(TUNE +, -) (37, 41)
- 9** SOUND MODE buttons (72)
 - MOVIE button
 - MUSIC button
 - GAME button
 - PURE button
- 10** FAVORITE STATION buttons
(1 – 3) (66)
- 11** Remote control signal transmitter (142)
- 12** SLEEP button (96, 102)
- 13** POWER button (⏻) (29, 101)
- 14** VOLUME buttons (▲▼) (30, 101)
- 15** OPTION button
..... (31, 35, 38, 47, 52, 54, 63)
- 16** ENTER button
..... (106, 108, 114, 119, 123, 127, 131)
- 17** SETUP button
..... (106, 108, 114, 119, 123, 127, 131)

Inserting the batteries

- Remove the rear lid in the direction of the arrow and remove it.
- Load the two batteries properly as indicated by the marks in the battery compartment.

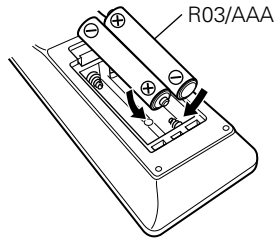
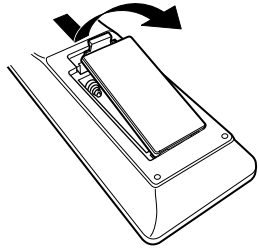

- Put the rear cover back on.

NOTE

- Insert the specified batteries in the remote control unit.
- Replace the batteries with new ones if the set does not operate even when the remote control unit is operated close to the unit. (The supplied batteries are only for verifying operation. Replace them with new batteries at an early date.)
- When inserting the batteries, be sure to do so in the proper direction, following the \oplus and \ominus marks in the battery compartment.
- To prevent damage or leakage of battery fluid:
 - Do not use a new battery together with an old one.
 - Do not use two different types of batteries.
 - Do not attempt to charge dry batteries.
 - Do not short-circuit, disassemble, heat or dispose of batteries in flames.
 - Do not keep the battery in a place exposed to direct sunlight or in places with extremely high temperatures, such as near a heater.
- If the battery fluid should leak, carefully wipe the fluid off the inside of the battery compartment and insert new batteries.
- Remove the batteries from the remote control unit if it will not be in use for long periods.
- Used batteries should be disposed of in accordance with the local regulations regarding battery disposal.
- The remote control unit may function improperly if rechargeable batteries are used.

Operating range of the remote control unit

Point the remote control unit at the remote sensor when operating it.

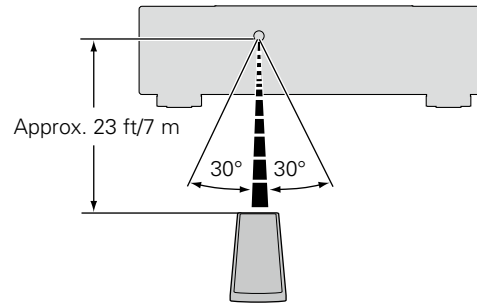

NOTE

- The set may function improperly or the remote control unit may not operate if the remote control sensor is exposed to direct sunlight, strong artificial light from an inverter type fluorescent lamp or infrared light.
- When using 3D video devices that transmit infrared communication signals (such as infrared signals etc) between the various units (such as the monitor, 3D glasses, 3D transmitter unit etc), the remote control unit may not operate due to interference from those communication signals. If this occurs, adjust the direction and distance of the 3D communication for each unit, and check that the remote control unit operation is not affected by these signals.

Specifying the zone used with the remote control unit

When the **ZONE2** button is pressed, only the MAIN ZONE can be operated with the remote control unit.

Press and hold ZONE2 and SETUP.
MAIN and **ZONE2** button blink.



To cancel

Press and hold ZONE2 and SETUP.
MAIN and **ZONE2** button blink.

Other information

- ❑ **Trademark information** ([page 143](#))
- ❑ **Surround** ([page 144](#))
- ❑ **Relationship between video signals and monitor output** ([page 148](#))
- ❑ **Explanation of terms** ([page 150](#))

Trademark information



Manufactured under license from Audyssey Laboratories™. U.S. and foreign patents pending. Audyssey MultEQ®, Audyssey Dynamic EQ® and Audyssey Dynamic Volume® are registered trademarks of Audyssey Laboratories.



Manufactured under license from Dolby Laboratories. “Dolby”, “Pro Logic” and the double-D symbol are trademarks of Dolby Laboratories.



Manufactured under license under U.S. Patent Nos: 5,956,674; 5,974,380; 6,226,616; 6,487,535; 7,212,872; 7,333,929; 7,392,195; 7,272,567 & other U.S. and worldwide patents issued & pending. DTS-HD, the Symbol, & DTS-HD and the Symbol together are registered trademarks & DTS-HD Master Audio is a trademark of DTS, Inc. Product includes software. © DTS, Inc. All Rights Reserved.



The terms HDMI and HDMI High-Definition Multimedia Interface, and the HDMI Logo are trademarks or registered trademarks of HDMI Licensing LLC in the United States and other countries.



“Made for iPod” and “Made for iPhone” mean that an electronic accessory has been designed to connect specifically to iPod, or iPhone, respectively, and has been certified by the developer to meet Apple performance standards.

Apple is not responsible for the operation of this device or its compliance with safety and regulatory standards. Please note that the use of this accessory with iPod, or iPhone, may affect wireless performance.

AirPlay, the AirPlay logo, iPad, iPhone, iPod, iPod classic, iPod nano, iPod shuffle and iPod touch are trademarks of Apple Inc., registered in the U.S. and other countries.

- Individual users are permitted to use iPhone, iPod, iPod classic, iPod nano, iPod shuffle, and iPod touch for private copy and playback of non-copyrighted contents and contents whose copy and playback is permitted by law. Copyright infringement is prohibited by law.



Windows Media and the Windows logo are trademarks or registered trademarks of Microsoft Corporation in the United States and/or other countries.



Adobe, the Adobe logo and Reader are either registered trademarks or trademarks of Adobe Systems Incorporated in the United States and/or other countries.

Surround

This unit is equipped with a sophisticated digital signal processing circuit that lets you play your favorite movie and music sources and listen to them with a wide range of surround sound mode choices.

Sound modes and surround parameters

This table shows the speakers that can be used in each sound mode and the surround parameters adjustable in each sound mode.

Symbols in the table

- This indicates the audio output channels or surround parameters that can be set.
- ◎ This indicates the audio output channels. The output channels depend on the settings of “Speaker Config.” ([page 124](#)).

Sound Mode (page 72)	Channel output						Surround Parameter (page 109)				
	Front L/R	Center	Surround L/R	Surround back L/R	Front height L/R	Subwoofer	Home Theater EQ (page 109)	Loudness Management *2 (page 109)	Dynamic Compression *3 (page 109)	Low Frequency Effects *4 (page 110)	Height Gain *5 (page 110)
DIRECT/PURE DIRECT (2-channel)*1	○					◎*8		○	○		
DIRECT/PURE DIRECT (Multi-channel)*1	○	◎	◎	◎*6	◎*6	◎		○	○	○	
STEREO	○					◎		○	○	○	
MULTI CH IN	○	◎	◎	◎	◎*7	◎	○			○	○
DOLBY PRO LOGIC IIz	○	◎	◎		◎	◎	○	○	○		○
DOLBY PRO LOGIC IIx	○	◎	◎	◎		◎	○	○	○		
DOLBY PRO LOGIC II	○	◎	◎			◎	○	○	○		
DTS NEO:6	○	◎	◎	◎		◎	○	○	○		
DOLBY DIGITAL	○	◎	◎	◎	◎*7	◎	○		○	○	○
DOLBY DIGITAL Plus	○	◎	◎	◎	◎*7	◎	○		○	○	○
DOLBY TrueHD	○	◎	◎	◎	◎*7	◎	○	○	○	○	○
DTS SURROUND	○	◎	◎	◎	◎*7	◎	○		○	○	○
DTS 96/24	○	◎	◎	◎	◎*7	◎	○		○	○	○
DTS-HD	○	◎	◎	◎	◎*7	◎	○		○	○	○
DTS Express	○	◎	◎	◎	◎*7	◎	○		○	○	○
MULTI CH STEREO	○	◎	◎	◎	◎	◎		○	○	○	
VIRTUAL	○					◎		○	○	○	

- *1 During playback in PURE DIRECT mode, the surround parameters are the same as in DIRECT mode.
- *2 This item can be selected when a Dolby TrueHD signal is played.
- *3 This item can be selected when a Dolby Digital or DTS signal is played.
- *4 This item can be selected when a Dolby Digital or DTS signal or DVD-Audio is played.
- *5 This setting is available when the set sound mode name contains “+PLIIz”. For information on how to check the sound mode, see [page 72](#).
- *6 A signal for each channel contained in an input signal is output as audio.
- *7 Audio is output from the front height speaker when the set sound mode name contains “+PLIIz”. For information on how to check the sound mode, see [page 72](#).
- *8 Only when “Subwoofer Mode” is set to “LFE+Main” ([page 126](#)), sound is output from the subwoofer.

Sound Mode (page 72)	Surround Parameter (page 109)				Subwoofer (page 109)	Tone *9 (page 111)	Audyssey (page 112)			M-DAX *12 (page 111)
	PRO LOGIC II/IIx Music mode only			NEO:6 Music mode only			MultEQ® *10 (page 112)	Dynamic EQ *11 (page 113)	Dynamic Volume *11 (page 113)	
	Panorama (page 110)	Dimension (page 110)	Center Width (page 110)	Center Image (page 110)						
DIRECT/PURE DIRECT (2-channel)*1					○*13					
DIRECT/PURE DIRECT (Multi-channel)*1					○					
STEREO					○	○	○	○	○	○
MULTI CH IN					○	○	○	○	○	○
DOLBY PRO LOGIC IIz					○	○	○	○	○	○
DOLBY PRO LOGIC IIx	○	○	○		○	○	○	○	○	○
DOLBY PRO LOGIC II	○	○	○		○	○	○	○	○	○
DTS NEO:6				○	○	○	○	○	○	○
DOLBY DIGITAL					○	○	○	○	○	
DOLBY DIGITAL Plus					○	○	○	○	○	
DOLBY TrueHD					○	○	○	○	○	
DTS SURROUND					○	○	○	○	○	
DTS 96/24					○	○	○	○	○	
DTS-HD					○	○	○	○	○	
DTS Express					○	○	○	○	○	
MULTI CH STEREO					○	○	○	○	○	○
VIRTUAL					○	○	○	○	○	○

*1 During playback in PURE DIRECT mode, the surround parameters are the same as in DIRECT mode.

*9 This item cannot be set when "Dynamic EQ" (page 113) is set to "On".

*10 For HD Audio whose sampling frequency of an input signal is more than 96 kHz, this sound parameter cannot be set.

*11 This item cannot be set when "MultEQ®" (page 112) is set to "Off" or "Graphic EQ".

*12 This item can be set when the input signal is analog, PCM 48 kHz or 44.1 kHz.

*13 Only when "Subwoofer Mode" is set to "LFE+Main" (page 126), sound is output from the subwoofer.

Types of input signals, and corresponding sound modes

This table shows the input signal that can be played in each sound mode. Check the audio signal of the input source then select the sound mode.

Symbols in the table

- This indicates the default sound mode.
- This indicates the selectable sound mode.

Sound Mode (🔗 page 72)	NOTE	Input signal types and formats															
		ANALOG	PCM		DTS-HD		DTS					DOLBY		DOLBY DIGITAL			
			PCM (Multi-channel)	PCM (2-channel)	DTS-HD Master Audio	DTS-HD High Resolution Audio	DTS EXPRESS	DTS ES DSCRT (With Flag)	DTS ES MTRX (With Flag)	DTS (5.1-channel)	DTS 96/24	DOLBY TrueHD	DOLBY DIGITAL Plus	DOLBY DIGITAL EX (With Flag)	DOLBY DIGITAL EX (With no Flag)	DOLBY DIGITAL (5.1-channel)	DOLBY DIGITAL (2-channel)
DTS SURROUND																	
DTS-HD MSTR					●												
DTS-HD HI RES						●											
DTS ES DSCRT6.1	*1*2							●									
DTS ES MTRX6.1	*1*2								●								
DTS SURROUND																	
DTS 96/24																	
DTS (-HD) + PLIIx MOVIE	*1*3				○	○	○										
DTS (-HD) + PLIIx MUSIC	*1*2				○	○	○										
DTS (-HD) + PLIIz	*4*5				○	○	○	○	○	○	○						
DTS EXPRESS								●									
DTS (-HD) + NEO:6	*1*2				○	○					○	○					
DTS NEO:6 CINEMA		○														○	
DTS NEO:6 MUSIC		○		○												○	
DOLBY SURROUND																	
DOLBY TrueHD													●				
DOLBY DIGITAL+														●			
DOLBY DIGITAL EX	*1*2													○	○	○	
DOLBY (D+) (HD) +EX	*1*2												○	○			
DOLBY DIGITAL															●	●	
DOLBY (D) (D+) (HD) +PLIIx MOVIE	*1*3													○	○	○	
DOLBY (D) (D+) (HD) +PLIIx MUSIC	*1*2													○	○	○	
DOLBY (D) (D+) (HD) +PLIIz	*4*5													○	○	○	
DOLBY PRO LOGIC IIx MOVIE	*1*2	○			○												
DOLBY PRO LOGIC IIx MUSIC	*1*2	○			○												
DOLBY PRO LOGIC IIx GAME	*1*2	○			○												
DOLBY PRO LOGIC IIz	*4*5	○			○												
DOLBY PRO LOGIC II MOVIE		○			○												
DOLBY PRO LOGIC II MUSIC		○			○												
DOLBY PRO LOGIC II GAME		○			○												

- *1 This sound mode can be selected when "Amp Assign" (🔗 page 124) is set to "Surround Back".
- *2 If "Speaker Config." - "Surr. Back" (🔗 page 124) is set to "None", this sound mode cannot be selected.
- *3 If "Speaker Config." - "Surr. Back" (🔗 page 124) is set to "1spkr" or "None", this sound mode cannot be selected.
- *4 If "Speaker Config." - "Front Height" (🔗 page 124) is set to "None", this sound mode cannot be selected.
- *5 This sound mode can be selected when "Assign Mode" (🔗 page 124) is set to "Front Height".

Sound Mode (page 72)	NOTE	Input signal types and formats																
		ANALOG	PCM		DTS-HD		DTS					DOLBY		DOLBY DIGITAL				
			PCM (Multi-channel)	PCM (2-channel)	DTS-HD Master Audio	DTS-HD High Resolution Audio	DTS EXPRESS	DTS ES DSCRT (With Flag)	DTS ES MTRX (With Flag)	DTS (5.1-channel)	DTS 96/24	DOLBY TrueHD	DOLBY DIGITAL Plus	DOLBY DIGITAL EX (With Flag)	DOLBY DIGITAL EX (With no Flag)	DOLBY DIGITAL (5.1-channel)	DOLBY DIGITAL (2-channel)	
MULTI CH IN																		
MULTI CH IN			●															
MULTI CH IN + PLIIx MOVIE	*1*3		○															
MULTI CH IN + PLIIx MUSIC	*1*2		○															
MULTI CH IN + PLIIz	*4*5		○															
MULTI CH IN + Dolby EX	*1*2		○															
MULTI CH IN 7.1	*1*2		● (7.1)															
DIRECT																		
DIRECT		○	○	○	○	○	○	○	○	○	○	○	○	○	○	○	○	○
PURE DIRECT																		
PURE DIRECT		○	○	○	○	○	○	○	○	○	○	○	○	○	○	○	○	○
DSP SIMULATION																		
MULTI CH STEREO		○	○	○	○	○	○	○	○	○	○	○	○	○	○	○	○	○
VIRTUAL		○	○	○	○	○	○	○	○	○	○	○	○	○	○	○	○	○
STEREO																		
STEREO		●	○	●	○	○	○	○	○	○	○	○	○	○	○	○	○	○

- *1 This sound mode can be selected when "Amp Assign" ([page 124](#)) is set to "Surround Back".
- *2 If "Speaker Config." - "Surr. Back" ([page 124](#)) is set to "None", this sound mode cannot be selected.
- *3 If "Speaker Config." - "Surr. Back" ([page 124](#)) is set to "1spkr" or "None", this sound mode cannot be selected.
- *4 If "Speaker Config." - "Front Height" ([page 124](#)) is set to "None", this sound mode cannot be selected.
- *5 This sound mode can be selected when "Assign Mode" ([page 124](#)) is set to "Front Height".

Relationship between video signals and monitor output

Video Conversion	MAIN ZONE MONITOR OUT								
	Input connector			Output connector			Menu displayed		
	HDMI	COMPONENT	VIDEO	HDMI	COMPONENT	VIDEO	HDMI	COMPONENT	VIDEO
On	×	×	×	×	×	×	Only the menu is displayed	×	×
On	×	×	○	○ <VIDEO>	×	○ <VIDEO>	○ (VIDEO)	×	× (VIDEO)
On	×	○	×	○ <COMPONENT>	○ <COMPONENT>	×	○ (COMPONENT)	× (COMPONENT)	×
On	×	○	○			○ <VIDEO>			×
On	○	×	×	○ <HDMI>	×	×	○ (HDMI)	×	×
On	○	×	○			○ <VIDEO>			×
On	○	○	×			×			×
On	○	○	○			○ <COMPONENT>			○ <VIDEO>
Off	×	×	×	×	×	×	Only the menu is displayed	×	×
Off	×	×	○			○ <VIDEO>			×
Off	×	○	×			×			×
Off	×	○	○			○ <COMPONENT>			○ <VIDEO>
Off	○	×	×	○ <HDMI>	×	×	Only the menu is displayed	×	×
Off	○	×	○			○ <VIDEO>			×
Off	○	○	×			×			×
Off	○	○	○			○ <COMPONENT>			○ <VIDEO>
Off	○	○	○			○ <VIDEO>		×	× (VIDEO)

○ : Video signal input present
 × : No video signal input

○ <>: The input signal between the < > marks is output.
 × : No video signal output

○ () : Superimposed on the picture indicated in ().
 × () : Only the picture in () is output.
 × : Neither the picture nor the menu is output.



The main zone video conversion function is compatible with the following formats: NTSC, PAL, SECAM, NTSC4.43, PAL-N, PAL-M and PAL-60.

NOTE

- The status display screen cannot be displayed at a computer's resolution (e.g. VGA) or while certain 3D video contents is being played.
- When the menu is operated on a computer's resolution (e.g. VGA) or during playback of certain 3D video content, the playback image switches to the menu screen image.

Video signal resolution conversion table

When “Video Conversion” ([page 116](#)) is set to “On”, “i/p Scaler” ([page 117](#)) is set to “Analog”, “Analog & HDMI” or “HDMI” are set, the resolution of the input video signal can be converted to a different resolution for output ([page 6](#) “Converting input video signals for HD output (Video conversion function”).

The relationship between the resolution of the convertible video signal and HDMI output resolution is shown in the table below.

	Input resolution	Output resolution	HDMI Output						
			480i/576i *1	480p/576p	1080i	720p	1080p	1080p 24Hz	4K *2
Video input	480i/576i		○	○	○	○	○	○	○
Component video input	480i/576i		○	○	○	○	○	○	○
	480p/576p		–	○	○	○	○	○	○
	1080i		–	–	○	○	○	○	○
	720p		–	–	○	○	○	○	○
	1080p		–	–	–	–	○	○	○
HDMI input	480i/576i		○	○	○	○	○	○	○
	480p/576p		–	○	○	○	○	○	○
	1080i		–	–	○	○	○	○	○
	720p		–	–	○	○	○	○	○
	1080p 24Hz		–	–	–	–	○*3	○*4	○
	1080p		–	–	–	–	○	○	○
	4K		–	–	–	–	–	–	○*5

○ The resolution set in “Resolution” ([page 117](#)) in the menu is output.

– Output at the same resolution as the input video signal resolution.

*1 Only output when “i/p Scaler” in the menu is set to “Off”.

*2 Output at a resolution of 3840 x 2160 pixels (24/25/30 Hz).

*3 The resolution set in “Resolution” ([page 117](#)) in the menu is set to “Auto”, and a television that does not support 1080p 24Hz video signals is connected.

*4 The resolution set in “Resolution” ([page 117](#)) in the menu is set to “Auto”, and a television that supports 1080p 24Hz video signals is connected.

*5 Output at the same resolution as the input video signal resolution.

NOTE

- The 4K, 3D, Computer resolution, “x.v.Color”, sYCC601 color, Adobe RGB color or Adobe YCC601 color input to HDMI is output at the same resolution as the input video signal.
- When “Video Mode” in the menu is set to “Game” or “Auto” and game contents are played, the same resolution as the input video signal is output.
- When “Resolution” in the menu is set to “Auto”, the number of pixels in the television panel connected to the HDMI output connector is automatically detected, and the optimum resolution is output according to the table above.
- If 1080p 24Hz signals input from the HDMI terminal are converted into 1080p 60Hz/1080p 50Hz for output, they are output according to the specified “Format” ([page 118](#)) setting in the menu:
 - “NTSC” – Output as 1080p 60Hz.
 - “PAL” – Output as 1080p 50Hz.
- You can not convert 60Hz into 50Hz or vice versa.
- You can not convert 50Hz into 24Hz.

Explanation of terms

A

A2DP

A2DP is one profile of Bluetooth defined for in-car devices or AV devices that use wireless communication instead of a cable.

Adobe RGB color, Adobe YCC601 color

The color space defined by Adobe Systems Inc. Because it is a wider color space than RGB, it can produce more vivid and natural images.

AirPlay

AirPlay sends (plays) contents recorded in iTunes or on an iPhone/iPod touch/iPad to a compatible device via the network.

ALAC (Apple Lossless Audio Codec)

This is a codec for lossless audio compression method developed by Apple Inc. This codec can be played back on iTunes, iPod or iPhone. Data compressed to approximately 60 – 70 % can be decompressed to exactly the same original data.

App Store

App Store is a site that sells application software for such devices as the iPhone or iPod Touch, and is operated by Apple Inc.

Audyssey Dynamic EQ®

Dynamic EQ solves the problem of deteriorating sound quality as volume is decreased by taking into account human perception and room acoustics. Audyssey Dynamic EQ® works in tandem with Audyssey MultEQ® to provide well-balanced sound for every listener at any volume level.

Audyssey Dynamic Volume®

Dynamic Volume solves the problem of large variations in volume level between television programs, commercials, and between the soft and loud passages of movies. Audyssey Dynamic EQ® is integrated into Dynamic Volume so that as the playback volume is adjusted automatically, the perceived bass response, tonal balance, surround impression, and dialog clarity remain the same.

Audyssey MultEQ®

MultEQ® is a room equalization solution that calibrates any audio system so that it can achieve optimum performance for every listener in a large listening area. Based on several room measurements, MultEQ® calculates an equalization solution that corrects for both time and frequency response problems in the listening area and also performs a fully automated surround system setup.

Auto Lip Sync

If you connect the unit to a TV that supports the Auto Lip Sync function, it can automatically correct delay between the audio and video.

B

Bluetooth

Bluetooth is a short-distance wireless communication technology used for connecting handheld devices several meters apart. This enables notebook computers, PDA s, mobile phones, etc. to connect without a cable for transmitting audio and data.

D

Deep Color

An imaging technology supported by HDMI. Unlike RGB, which uses 8 bits (256 shades) per color, it can use 10 bits (1024 shades), 12 bits (4096 shades), or 16 bits (65536 shades) to produce colors in higher definition.

Both devices linked via HDMI must support Deep Color.

DLNA

DLNA and DLNA CERTIFIED are trademarks and/or service marks of Digital Living Network Alliance. Some contents may not be compatible with other DLNA CERTIFIED® products.

Dolby Digital

Dolby Digital is a multi-channel digital signal format developed by Dolby Laboratories.

A total of 5.1 channels are played: 3 front channels ("FL", "FR" and "C"), 2 surround channels ("SL" and "SR") and the "LFE" channel for low frequencies.

Because of this, there is no crosstalk between channels and a realistic sound field with a "three-dimensional" feeling (sense of distance, movement and positioning) is achieved. This delivers a thrilling surround sound experience in the home.

Dolby Digital EX

Dolby Digital EX is a 6.1-channel surround format from Dolby Laboratories that allows users to enjoy in their homes the "DOLBY DIGITAL SURROUND EX" audio format jointly developed by Dolby Laboratories and Lucasfilm.

The 6.1 channels of sound, including surround back channel, provide improved sound positioning and expansion of the surround sound field.

Dolby Digital Plus

Dolby Digital Plus is an improved Dolby Digital signal format that is compatible with up to 7.1 channels of discrete digital sound and also improves sound quality thanks to extra data bit rate performance. It is upwardly compatible with conventional Dolby Digital, so it offers greater flexibility in response to the source signal and the conditions of the playback device.

Dolby Pro Logic II

Dolby Pro Logic II is a matrix decoding technology developed by Dolby Laboratories.

Regular music such as that on CDs is encoded into 5 channels to achieve an excellent surround effect. The surround channel signals are converted into stereo and full band signals (with a frequency response of 20 Hz to 20 kHz or greater) to create a "three-dimensional" sound image offering a rich sense of presence for all stereo sources.

Dolby Pro Logic IIx

Dolby Pro Logic IIx is a further improved version of the Dolby Pro Logic II matrix decoding technology. Audio signals recorded in 2 channels are decoded to achieve a natural sound with up to 7.1 channels. There are three modes: "Music" suited for playing music, "Movie" suited for playing movies, and "Game" which is optimized for playing games.

Dolby Pro Logic IIz

Dolby Pro Logic IIz introduces a new dimension to Home Entertainment through the addition of a pair of front height channels. Compatible with stereo, 5.1-channel and 7.1-channel content, Dolby Pro Logic IIz provides enhanced spaciousness, depth and dimension to movies, concert video and video game playback while maintaining the full integrity of the source mix.

Dolby Pro Logic IIz identifies and decodes spatial cues that occur naturally in all content, directing this information to the front height channels, complementing the performance of left and right surround sound speakers. Content that is encoded with Dolby Pro Logic IIz height channel information can be even more revealing, with perceptually discrete height channel information bringing an exciting new dimension to home entertainment.

Dolby Pro Logic IIz, with front height channels is also an ideal alternative for households that cannot support the placement of back surround speakers of a typical 7.1-channel system but may have bookshelf space available to support the addition of height speakers.

Dolby TrueHD

Dolby TrueHD is a high definition audio technology developed by Dolby Laboratories, using lossless coding technology to faithfully reproduce the sound of the studio master.

This format provides the facility to support up to 8 audio channels with a sampling frequency of 96 kHz/24 bit resolution and up to 6 audio channels with a sampling frequency of 192 kHz/24 bit resolution. Dolby TrueHD is adopted for applications that put very high importance on sound quality.

Downmix

This function converts the number of channels of surround audio to a lower number of channels and plays back according to the system's configuration.

DTS

This is an abbreviation of Digital Theater System, which is a digital audio system developed by DTS. DTS delivers a powerful and dynamic surround sound experience, and is found in the world's finest movie theaters and screening rooms.

DTS 96/24

DTS 96/24 is a digital audio format enabling high sound quality playback in 5.1 channels with a sampling frequency of 96 kHz and 24 bit quantization on DVD-Video.

DTS Digital Surround

DTS Digital Surround is the standard digital surround format of DTS, Inc., compatible with a sampling frequency of 44.1 or 48 kHz and up to 5.1 channels of digital discrete surround sound.

DTS-ES™ Discrete 6.1

DTS-ES™ Discrete 6.1 is a 6.1-channel discrete digital audio format adding a surround back (SB) channel to the DTS digital surround sound. Decoding of conventional 5.1-channel audio signals is also possible according to the decoder.

DTS-ES™ Matrix 6.1

DTS-ES™ Matrix 6.1 is a 6.1-channel audio format that inserts a surround back (SB) channel to the DTS digital surround sound through matrix encoding. Decoding of conventional 5.1-channel audio signals is also possible according to the decoder.

DTS Express

DTS Express is an audio format supporting low bit rates (max. 5.1 channels, 24 to 256 kbps).

DTS-HD

This audio technology provides higher sound quality and enhanced functionality than the conventional DTS and is adopted as an optional audio for Blu-ray Disc. This technology supports multi-channel, high data transfer speed, high sampling frequency, and lossless audio playback. Maximum 7.1-channels are supported in Blu-ray Disc.

DTS-HD High Resolution Audio

DTS-HD High Resolution Audio is an improved version of the conventional DTS, DTS-ES and DTS 96/24 signals formats, compatible with sampling frequencies of 96 or 48 kHz and up to 7.1 channels of discrete digital sound. High data bit rate performance provides high quality sound. This format is fully compatible with conventional products, including conventional DTS digital surround 5.1-channel data.

DTS-HD Master Audio

DTS-HD Master Audio is a lossless audio format created by Digital Theater System (DTS). This format provides the facility to support up to 8 audio channels with a sampling frequency of 96 kHz/24 bit resolution and up to 6 audio channels with a sampling frequency of 192 kHz/24 bit resolution. It is fully compatible with conventional products, including conventional DTS digital surround 5.1-channel data.

DTS NEO:6™ Surround

DTS NEO:6™ is a matrix decoding technology for achieving 6.1-channel surround playback with 2-channel sources. It includes "DTS NEO:6 Cinema" suited for playing movies and "DTS NEO:6 Music" suited for playing music.

Dynamic range

The difference between the maximum undistorted sound level and the minimum discernible level above the noise emitted by the device.

F**FLAC**

FLAC stands for Free lossless Audio Codec, and is a lossless free audio file format. Lossless means that the audio is compressed without any loss in quality. The FLAC license is as shown below.

Copyright (C) 2000, 2001, 2002, 2003, 2004, 2005, 2006, 2007, 2008, 2009 Josh Coalson

Redistribution and use in source and binary forms, with or without modification, are permitted provided that the following conditions are met:

- Redistributions of source code must retain the above copyright notice, this list of conditions and the following disclaimer.
 - Redistributions in binary form must reproduce the above copyright notice, this list of conditions and the following disclaimer in the documentation and/or other materials provided with the distribution.
 - Neither the name of the Xiph.org Foundation nor the names of its contributors may be used to endorse or promote products derived from this software without specific prior written permission.
- THIS SOFTWARE IS PROVIDED BY THE COPYRIGHT HOLDERS AND CONTRIBUTORS "AS IS" AND ANY EXPRESS OR IMPLIED WARRANTIES, INCLUDING, BUT NOT LIMITED TO, THE IMPLIED WARRANTIES OF MERCHANTABILITY AND FITNESS FOR A PARTICULAR PURPOSE ARE DISCLAIMED. IN NO EVENT SHALL THE FOUNDATION OR CONTRIBUTORS BE LIABLE FOR ANY DIRECT, INDIRECT, INCIDENTAL, SPECIAL, EXEMPLARY, OR CONSEQUENTIAL DAMAGES (INCLUDING, BUT NOT LIMITED TO, PROCUREMENT OF SUBSTITUTE GOODS OR SERVICES; LOSS OF USE, DATA, OR PROFITS; OR BUSINESS INTERRUPTION) HOWEVER CAUSED AND ON ANY THEORY OF LIABILITY, WHETHER IN CONTRACT, STRICT LIABILITY, OR TORT (INCLUDING NEGLIGENCE OR OTHERWISE) ARISING IN ANY WAY OUT OF THE USE OF THIS SOFTWARE, EVEN IF ADVISED OF THE POSSIBILITY OF SUCH DAMAGE.

H**HDCP**

When transmitting digital signals between devices, this copyright protection technology encrypts the signals to prevent content from being copied without authorization.

HDMI

This is an abbreviation of High-Definition Multimedia Interface, which is an AV digital interface that can be connected to a TV or amplifier. Video signals and audio signals can be connected using a single cable.

I**iTunes**

iTunes is the name of the multimedia player provided by Apple Inc. It enables management and playback of multimedia contents including music and movies. iTunes supports many main file formats including AAC, WAV, and MP3.

L**LFE**

This is an abbreviation of Low Frequency Effect, which is an output channel that emphasizes low frequency effect sound. Surround audio is intensified by outputting 20 Hz to 120 Hz deep bass to the system subwoofer(s).

M**MAIN ZONE**

The room where this unit is placed is called the MAIN ZONE.

MP3 (MPEG Audio Layer-3)

This is an internationally standardized audio data compression scheme, using the "MPEG-1" video compression standard. It compresses the data volume to about one eleventh its original size while maintaining sound quality equivalent to a music CD.

MPEG (Moving Picture Experts Group),**MPEG-2, MPEG-4**

These are the names for digital compression format standards used for the encoding of video and audio. Video standards include "MPEG-1 Video", "MPEG-2 Video", "MPEG-4 Visual", "MPEG-4 AVC". Audio standards include "MPEG-1 Audio", "MPEG-2 Audio", "MPEG-4 AAC".

P**Pairing**

Pairing is an operation required for settings to connect two Bluetooth devices. Pairing enables Bluetooth devices to access each other.

Progressive (sequential scanning)

This is a scanning system of the video signal that displays 1 frame of video as one image. Compared to the interlace system, this system provides images with less flickering and jagged edges.

Protection Circuit

This is a function to prevent damage to devices within the power supply when an abnormality such as an overload, excess voltage occurs or over temperature for any reason.

In this unit, the power indicator blinks and the unit enters standby mode when an abnormality occurs.

S**Sampling frequency**

Sampling involves taking a reading of a sound wave (analog signal) at regular intervals and expressing the height of the wave at each reading in digitized format (producing a digital signal).

The number of readings taken in one second is called the "sampling frequency". The larger the value, the closer the reproduced sound is to the original.

Speaker impedance

This is an AC resistance value, indicated in Ω (Ohms). Greater power can be obtained when this value is smaller.

sYCC601 color

Like "x.v.Color", each of these color spaces defines a palette of available colors that is larger than the traditional RGB color model.

V**vTuner**

This is a free online content server for Internet Radio. Note that usage fees are included in upgrade costs.

For inquiries about this service, visit the vTuner site below.

vTuner website: <http://www.radiomarantz.com>

This product is protected by certain intellectual property rights of Nothing Else Matters Software and BridgeCo. Use or distribution of such technology outside of this product is prohibited without a license from Nothing Else Matters Software and BridgeCo or an authorized subsidiary.

W**Windows Media DRM**

This is a copyright protection technology developed by Microsoft.

Content providers are using the digital rights management technology for Windows Media contained in this device (WM-DRM) to protect the integrity of their content (Secure Content) so that their intellectual property, including copyright, in such content is not misappropriated. This device uses WM-DRM software to play Secure Content (WM-DRM Software). If the security of the WM-DRM Software in this device has been compromised, owners of Secure Content (Secure Content Owners) may request that Microsoft revoke the WM-DRM Software's right to acquire new licenses to copy, display and/or play Secure Content. Revocation does not alter the WM-DRM Software's ability to play unprotected content. A list of revoked WM-DRM Software is sent to your device whenever you download a license for Secure Content from the Internet or from a PC. Microsoft may, in conjunction with such license, also download revocation list onto your device on behalf of Secure Content Owners.

Windows Media Player Ver.11 or later

This is a media player distributed free of charge by Microsoft Corporation.

It can play playlists created with Ver.11 or later of Windows Media Player, as well as WMA, DRM WMA, WAV, and other files.

WMA (Windows Media Audio)

This is audio compression technology developed by Microsoft Corporation.

WMA data can be encoded using Windows Media® Player.

To encode WMA files, only use applications authorized by Microsoft Corporation. If you use an unauthorized application, the file may not work properly.

X**x.v.Color**

This function lets HDTVs display colors more accurately. It enables display with natural, vivid colors. "x.v.Color" is trademark of Sony Corporation.

Z**ZONE2**

This unit can operate in a room other than the room where this unit is placed (MAIN ZONE) (ZONE2 playback). The room for ZONE2 playback is called ZONE2.

Troubleshooting

If a problem should arise, first check the following:

1. Are the connections correct?

2. Is the set being operated as described in the owner's manual?

3. Are the other devices operating properly?

If this unit does not operate properly, check the items listed in the table below. Should the problem persist, there may be a malfunction.

In this case, disconnect the power immediately and contact your store of purchase.

[General]

Symptom	Cause/Solution	Page
Power does not turn on.	<ul style="list-style-type: none"> Check whether the power plug is correctly inserted into the power outlet. The protection circuit is active. Disconnect the power plug from the electric outlet, wait 5 to 10 seconds and then insert it back into the outlet. 	21 151
Power automatically switches to standby mode.	<ul style="list-style-type: none"> The sleep timer is set. Turn on the power again, or change the sleep timer settings. "Auto Standby" is triggered when there is no operation for a set amount of time. To disable "Auto Standby", set "Auto Standby" on the menu to "Off". 	96, 102 133
Display is off.	<ul style="list-style-type: none"> Set "Display" on the menu to something other than "Off". 	133
The power indicator is blinking red in intervals of approximately 2 seconds.	<ul style="list-style-type: none"> Due to the temperature rise within this unit, the protection circuit is working. Please turn off power once, and re-apply the power after the temperature has fallen sufficiently. Please re-install this unit in a place having good ventilation. 	151 -
The power indicator is blinking red in intervals of approximately 0.5 seconds.	<ul style="list-style-type: none"> Please use speakers which have the specified impedance. The protection circuit has been activated because the speaker cable core wires are touching, a core wire has come loose from the terminal, or a core wire is touching the rear panel of this unit. After unplugging the power cord, take corrective action such as firmly re-twisting the core wire or taking care of the terminal, and then reconnect the wire. 	81 81

Symptom	Cause/Solution	Page
After turning on the power, the power indicator is blinking red in intervals of approximately 0.5 seconds.	<ul style="list-style-type: none"> This unit's amplifier circuit has failed. Turn off the power and please contact the Marantz service adviser. 	-
Set does not operate properly.	<ul style="list-style-type: none"> Reset the microprocessor. Note that re-setting the microprocessor restores all pre-configured settings to the factory defaults. 	157

[HDMI]

Symptom	Cause/Solution	Page
No audio is output with HDMI connection.	<ul style="list-style-type: none"> Check the connection of the HDMI connectors. When outputting HDMI audio from the speakers, set "HDMI Audio Out" on the menu to "AVR". When outputting HDMI audio from a TV, set "HDMI Audio Out" on the menu to "TV". 	9, 10 115 115
No video is output with HDMI connection.	<ul style="list-style-type: none"> Check the connection of the HDMI connectors. Set the input source to match the connected HDMI connector. Check whether the TV is compatible with copyright protection (HDCP). If connected to a device not compatible with HDCP, video will not be output correctly. 	9, 10 9, 10, 29 11
When the following operations are performed on devices compatible with HDMI control, the same operations occur on this unit. <ul style="list-style-type: none"> Power ON/OFF Switching audio output devices Adjust volume Switch input source 	<ul style="list-style-type: none"> Set "HDMI Control" in the menu to "Off". Furthermore, if you do not want to link the power off operation with devices compatible with HDMI control, set "Power Off Control" in the menu to "Off".	95, 116

[Video]

Symptom	Cause/Solution	Page
No picture appears.	<ul style="list-style-type: none"> • Check the connection between the video output terminal of this unit and the input terminal of the TV. • Match the input settings to the input terminal of the TV connected to this unit. 	<p>13, 14</p> <p>–</p>

[Audio]

Symptom	Cause/Solution	Page
Audio is not output.	<ul style="list-style-type: none"> • Check the connections for all devices. • Check the speaker connections and configurations. • Check whether the audio device power is turned on. • Adjust the master volume. • Cancel the mute mode. • Check the connection with the playback device and select the proper input source. • Match the input mode and the terminal assigned to be the digital input terminal. • Disconnect the headphones. No sound is output from the speakers when headphones are connected. 	<p>9, 10, 13, 14, 15, 16, 17, 18, 19, 20, 21</p> <p>83, 84, 85, 86, 87, 88, 89, 90</p> <p>–</p> <p>30, 101 30, 101 29, 101</p> <p>122</p> <p>138</p>
The volume does not increase.	<ul style="list-style-type: none"> • The maximum volume is set too low. Set the maximum volume using "Limit" on the menu. • Power for external devices connected to the output connectors of the unit may not be turned on. Check the power of connected external devices. 	<p>112</p> <p>–</p>
No sound is produced from surround speakers.	<ul style="list-style-type: none"> • Check if the surround speakers are connected to the SURROUND terminals. 	–
No sound is produced from surround back speakers.	<ul style="list-style-type: none"> • Check if "Assign Mode" is set appropriately in order to output audio from the surround back speakers. • Set "Speaker Config." – "Surr. Back" on the menu to something other than "None". • Set the sound mode to something other than "STEREO" and "VIRTUAL". 	<p>124</p> <p>124</p> <p>72</p>

Symptom	Cause/Solution	Page
No sound is produced from front height speakers.	<ul style="list-style-type: none"> • Check if "Assign Mode" is set appropriately in order to output audio from the front height speakers. • Set "Speaker Config." – "Front Height" on the menu to something other than "None". 	<p>124</p> <p>124</p>
No sound is produced from subwoofer.	<ul style="list-style-type: none"> • Check the subwoofer connections. • Turn on the subwoofer's power. • Set "Speaker Config." – "Subwoofer" on the menu to "Yes". • If "Front" and "Center" for "Speaker Config." are set to "Large", and "Subwoofer Mode" is set to "LFE", no sound may be output from the subwoofers, depending on the input signal or selected sound mode. 	<p>83, 84, 85, 86, 87, 88, 89, 90</p> <p>–</p> <p>124 124, 126</p>
DTS sound is not output.	<ul style="list-style-type: none"> • Set "Decode Mode" on the menu to "Auto" or "DTS". 	122
Dolby TrueHD, DTS-HD, Dolby Digital Plus audio is not output.	<ul style="list-style-type: none"> • Make HDMI connections. 	9 , 10
Dolby PLII mode or DTS NEO:6 mode cannot be selected.	<ul style="list-style-type: none"> • Check that "Speaker Config." – "Center" or "Surround" is set to other than "None". If the speaker system is 2.0/2.1-channel, this sound mode cannot be selected. • When headphones are used, Dolby PLII or DTS NEO:6 cannot be selected. 	<p>124</p> <p>–</p>
Audyssey MultEQ®, Audyssey Dynamic EQ® and Audyssey Dynamic Volume® cannot be selected.	<ul style="list-style-type: none"> • Switch the sound mode to other than "DIRECT" or "PURE DIRECT". • When headphones are used, Audyssey MultEQ®, Audyssey Dynamic EQ® and Audyssey Dynamic Volume® cannot be selected. 	<p>72</p> <p>–</p>
Audyssey Dynamic EQ® and Audyssey Dynamic Volume® cannot be selected.	<ul style="list-style-type: none"> • Run Audyssey® Setup. 	22 , 91
"M-DAX" cannot be selected.	<ul style="list-style-type: none"> • Check that an analog signal or PCM signal (Sample Rate=44.1/48 kHz) is input. For playback of multichannel signals such as Dolby Digital or DTS surround, "M-DAX" cannot be used. • Switch the sound mode to other than "DIRECT" or "PURE DIRECT". 	<p>111</p> <p>72</p>

[FM/AM]

Symptom	Cause/Solution	Page
Reception fails, or there is a lot of noise or distortion.	<ul style="list-style-type: none"> • Change the antenna orientation or position. • Separate the AM loop antenna from the unit. • Use an FM outdoor antenna. • Separate the antenna from other connection cables. 	18 18 18 18



[iPod / USB memory device / Internet Radio / Media Server / Flickr / Pandora / SiriusXM / Spotify]

Symptom	Cause/Solution	Page
iPod cannot be played.	<ul style="list-style-type: none"> • Some iPods do not support being used connected directly to the USB port. 	16
The file names are not displayed properly ("...", etc.).	<ul style="list-style-type: none"> • Characters that cannot be displayed are used. This is not a malfunction. On this unit, characters that cannot be displayed are replaced with a "." (period). • Invalid tags are used for files within the USB memory device connected to this unit. Use tags that are supported by this unit. 	– 34
When a USB memory device is connected, "No Connection" is displayed.	<ul style="list-style-type: none"> • The set cannot recognize a USB memory device. Check the connection. • This unit supports mass storage class and MTP-compatible USB memory devices. It will not recognize other USB memory devices. • A USB memory device that the set cannot recognize is connected. This is not a malfunction. Marantz does not guarantee that all USB memory devices will operate or receive power. • USB memory device is connected via USB hub. Connect the USB memory device directly to the USB port. • The unit supports file structures with up to 8 levels and a total maximum of 5000 subfolders and files per 1 folder. Change the file structure of the USB memory device if necessary. 	16 – – – 34
Files on a USB memory device cannot be played.	<ul style="list-style-type: none"> • The USB memory device format should be set to FAT16 or FAT32. For details, refer to the USB memory device's operating instructions. • If the USB memory device is divided into multiple partitions, only files in partition one can be played. • Files are stored in a non-compatible format. Record the files in a compatible format. • You are attempting to play a file that is copyright protected. Files that are copyright protected cannot be played on this unit. 	– – 34 34

Symptom	Cause/Solution	Page
Internet Radio cannot be played.	<ul style="list-style-type: none"> • LAN cable is not properly connected or network is disconnected. Check the connection status. • Program is being broadcast in non-compatible format. Only Internet Radio programs in MP3 and WMA can be played on this unit. • The firewall of the PC or router has been activated. Check the firewall settings of the connected PC or router. • Radio station is not currently broadcasting. Choose a radio station that is currently broadcasting. • IP address is wrong. Check the set's IP address. • Some radio stations may go silent at certain times of the day. In this case, no audio is output even when a station is received. Try again later, or switch to another radio station. 	20 46 – 46 128 –
Files stored on a computer cannot be played.	<ul style="list-style-type: none"> • Files are stored in a non-compatible format. Record in a compatible format. • You are attempting to play a file that is copyright protected. Files that are copyright protected cannot be played on this unit. • Set and computer are connected by USB cable. The set's USB port cannot be used for connection to a computer. • Media sharing settings are not correct. Change media sharing settings so that the unit can access the folders on your computer. 	49 49 – 50
Music stored on a NAS cannot be played.	<ul style="list-style-type: none"> • If you use a NAS in conformity with the DLNA standard, enable the DLNA server function in the NAS setting. • If you use a NAS that does not conform with the DLNA standard, play the music via a PC. Set Windows Media Player's media sharing function and add NAS to the selected play folder. • If connection is restricted, set audio equipment as the connection target. 	– 50 –
Server is not found, or it is not possible to connect to the server.	<ul style="list-style-type: none"> • The computer's or router's firewall is activated. Check the computer's or router's firewall settings. • Computer's power is not turned on. Turn on the power. • Server is not running. Launch the server. • Set's IP address is wrong. Check the set's IP address. 	– – – 128
Cannot connect to preset or favorite radio stations.	<ul style="list-style-type: none"> • Radio station is not currently broadcasting. Wait a while before trying again. • Radio station is not currently in service. It is not possible to connect to radio stations that are no longer in service. 	– –

Symptom	Cause/Solution	Page
A list of broadcasting stations is not displayed.	<ul style="list-style-type: none"> • Connection to the network is unstable. Reconnect to the network or redo the "Network" setting in the menu. 	20 , 127
For some radio stations, "Radio station server full" or "Connection down" is displayed and station cannot be connected to.	<ul style="list-style-type: none"> • Station is congested or not currently broadcasting. Wait a while before trying again. 	–
Sound is broken during playback.	<ul style="list-style-type: none"> • Network or USB memory device's signal transfer speed is slow or communications lines or radio station is congested. This is not a malfunction. When playing broadcast data with a high bit rate, the sound may be broken, depending on the communications conditions. 	–
Sound quality is poor or noise is heard during play.	<ul style="list-style-type: none"> • File being played has a low bit rate. This is not a malfunction. 	–
Cannot login to Pandora. ("Email address" or "Password" is displayed.)	<ul style="list-style-type: none"> • Login information is incorrect. Check if the "Email address" for Pandora has been properly entered. Re-enter the "Password". (Password is not displayed.) http://www.pandora.com/marantz 	56

[AirPlay]

Symptom	Cause/Solution	Page
The AirPlay icon  is not displayed in iTunes or on the iPhone/iPod touch/iPad.	<ul style="list-style-type: none"> • This unit and the computer or iPhone/iPod touch/iPad are not connected to the same network (LAN). Connect the computer or iPhone/iPod touch/iPad to the same network as this unit. • iTunes or the iPhone/iPod touch/iPad do not have firmware that supports AirPlay installed. Update to the latest firmware. 	20 –
No sound.	<ul style="list-style-type: none"> • The volume in iTunes or on the iPhone/iPod touch/iPad is set to the minimum setting. Adjust the volume to the optimum level. • This unit is not selected in the screen that is displayed when iTunes or the iPhone/iPod touch/iPad is started. Start iTunes or switch on the iPhone/iPod touch/iPad, click the AirPlay icon  in the displayed screen, and select this unit. • AirPlay playback has not started. Click the ► button in iTunes or press the ► button on the iPhone/iPod touch/iPad. 	– 70 –
When using AirPlay with the iPhone/iPod touch/iPad, the sound suffers from intermittent breaks or AirPlay does not function.	<ul style="list-style-type: none"> • Quit the application running in the background of the iPhone/iPod touch/iPad, and then play using AirPlay. • When playing via a wireless connection, outside conditions may affect the unit. To remedy this, change the network environment, e.g. shorten the distance to the wireless LAN access point. • Update the iPhone/iPod touch/iPad application or iTunes to the latest version. 	– – –

[M-XPort]

Symptom	Cause/Solution	Page
Audio is not output when a wireless receiver (RX101 is connected).	<ul style="list-style-type: none"> • Check that the Bluetooth device and Wireless receiver (RX101) are correctly paired. 	19 , 150 , 151

[Remote control unit]

Symptom	Cause/Solution	Page
The set cannot be operated with the remote control unit.	• Batteries are worn out. Replace with new batteries.	142
	• Operate the remote control unit within a distance of about 23 ft/7 m from this unit and at an angle of within 30°.	142
	• Remove any obstacle between this unit and the remote control unit.	142
	• Insert the batteries in the proper direction, checking the ⊕ and ⊖ marks.	142
	• The set's remote control sensor is exposed to strong light (direct sunlight, inverter type fluorescent bulb light, etc.). Move the set to a place in which the remote control sensor will not be exposed to strong light.	142
	• The setting of the zone to operate does not match. Press MAIN or ZONE2 to select the zone to operate.	23 , 91 , 101

Resetting the microprocessor

Perform this procedure if the display is abnormal or if operations cannot be performed. Note that when the microprocessor is reset, all the settings are reset to their default values.

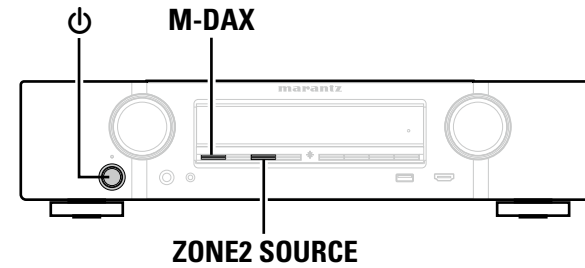

1 Turn off the power using ⏻.

2 Press ⏻ while simultaneously pressing **M-DAX** and **ZONE2 SOURCE**.

3 Once the display starts flashing at intervals of about 1 second, release the two buttons.



If in step 3 the display does not flash at intervals of about 1 second, start over from step 1.

Specifications

□ Audio section

• Power amplifier

Rated output:

Front:
50 W + 50 W (8 Ω/ohms, 20 Hz – 20 kHz with 0.08 % T.H.D.)
70 W + 70 W (6 Ω/ohms, 1 kHz with 0.7 % T.H.D.)

Center:
50 W (8 Ω/ohms, 20 Hz – 20 kHz with 0.08 % T.H.D.)
70 W (6 Ω/ohms, 1 kHz with 0.7 % T.H.D.)

Surround:
50 W + 50 W (8 Ω/ohms, 20 Hz – 20 kHz with 0.08 % T.H.D.)
70 W + 70 W (6 Ω/ohms, 1 kHz with 0.7 % T.H.D.)

Surround back:
50 W + 50 W (8 Ω/ohms, 20 Hz – 20 kHz with 0.08 % T.H.D.)
70 W + 70 W (6 Ω/ohms, 1 kHz with 0.7 % T.H.D.)

6 – 8 Ω/ohms

Output connectors:

• Analog

Input sensitivity/Input impedance:

130 mV/47 kΩ/kohms

Frequency response:

10 Hz – 100 kHz — +1, –3 dB (DIRECT mode)

S/N:

98 dB (IHF–A weighted, DIRECT mode)

□ Video section

• Standard video connectors

Input/output level and impedance:

1 Vp-p, 75 Ω/ohms

Frequency response:

5 Hz – 10 MHz — 0, –3 dB

• Color component video connector

Input/output level and impedance:

Y signal — 1 Vp-p, 75 Ω/ohms
P_B / C_B signal — 0.7 Vp-p, 75 Ω/ohms
P_R / C_R signal — 0.7 Vp-p, 75 Ω/ohms

Frequency response:

5 Hz – 60 MHz — 0, –3 dB

□ Tuner section

Receiving Range:

	[FM]	[AM]
(Note: μV at 75 Ω/ohms, 0 dBf = 1 × 10 ⁻¹⁵ W)		
87.5 MHz – 107.9 MHz		520 kHz – 1710 kHz

Usable Sensitivity:

1.2 μV (12.8 dBf)

18 μV

50 dB Quieting Sensitivity:

MONO 2.8 μV (20.2 dBf)

S/N :

MONO 70 dB (IHF–A weighted, DIRECT mode)

STEREO 67 dB (IHF–A weighted, DIRECT mode)

Total harmonic Distortion:

MONO 0.7 % (1 kHz)

STEREO 1.0 % (1 kHz)

□ General

Power supply:

AC 120 V, 60 Hz

Power consumption:

220 W

Power consumption in standby mode:

0.2 W

Power consumption in CEC standby mode:

0.5 W

Power consumption in network standby mode:

2.7 W

For purposes of improvement, specifications and design are subject to change without notice.

Index

Numerics

2.1-channel	88
3D	11
4K	11
5.1-channel	80, 86
6.1-channel	80, 85
7.1-channel	79, 80, 83, 84

A

A2DP	19, 150
Accessories	2
Add New Feature	136
Adjust EQ	113
Adjusting the master volume	30
Adobe RGB color / Adobe YCC601 color	150
AirPlay	70, 150
ALAC	150
All Zone Stereo	69
AM loop antenna	18
Amp Assign	124
App Store	150
ARC	8
Aspect Ratio	117
Audio	108
Audio Delay	112
Audyssey	112
Audyssey Dynamic EQ®	113, 150
Audyssey Dynamic Volume®	113, 150
Audyssey MultEQ®	112, 150
Audyssey® Setup	22, 91
Auto Lip Sync	115, 150
Auto Preset Memory	42
Auto Standby	133

B

Bass	111, 126
Bi-amp	89
Bluetooth	19, 150
Brightness	115

C

Cable	
Audio cable	12
Coaxial digital cable	12
Component video cable	12
HDMI cable	9, 10
LAN cable	12
Optical cable	12
Speaker cable	82
Subwoofer cable	82
Video cable	12
Center Gain	110
Center Width	110
Characters	107
Check Results	28
Condensation	3
Connection	
Blu-ray Disc player	10
Cable TV	14
CD player	17
DC OUT	94
DVD player	10, 15
FM/AM	18
Game console	10
HDMI	7
Home network (LAN)	20
iPod (USB)	16
Media player	10
Power cord	21
REMOTE CONTROL connectors	93
Satellite tuner	14
Set-top box	10, 14
Speaker	81
TV	9, 13
USB memory device	16
Video camcorder	10
Wireless receiver	19
Content Type	11
Contrast	115
Crossovers	126
Curve Copy	113

D

Decode Mode	122
Deep Color	11, 150
Diagnostics	130
Dialog Level	109
Dimension	110
Direct Tune	39
Display	133, 139
Distances	125
DLNA	150
Dolby	
Dolby Digital	76, 150
Dolby Digital EX	76, 150
Dolby Digital Plus	76, 150
Dolby Pro Logic II	76, 150
Dolby Pro Logic IIx	76, 150
Dolby Pro Logic IIz	76, 79, 150
Dolby TrueHD	76, 150
Downmix	150
DTS	150
DTS 96/24	76, 150
DTS Digital Surround	150
DTS-ES Discrete 6.1	76, 150
DTS-ES Matrix 6.1	76, 150
DTS Express	76, 151
DTS-HD	76, 151
DTS-HD High Resolution Audio	151
DTS-HD Master Audio	151
DTS Neo:6	76, 79
DTS NEO:6™ Surround	151
Dual backup memory function	99
Dynamic Compression	109
Dynamic EQ	113
Dynamic range	151
Dynamic Volume	113

E

Edit Name	128
Enhancer	115
Error messages (Audyssey® Setup)	27

F

Firmware	135
FLAC	151
Flickr	53, 54
FM/AM	37

FM indoor antenna	18
Format	118
Friendly Name	128
Front A/B (connection)	80, 87
Front Display	133
Front Height	124
Front height speaker	79, 84
Front Panel	138
Front Speaker	126

G

General	131
Graphic EQ	113

H

HDCP	11, 151
HDMI	7, 11, 151
HDMI Audio Out	115
HDMI Control	116
HDMI control function	95
HDMI Pass Through	115
HDMI Setup	115
Headphones	138
Height Gain	110
Hide Sources	122
Home Theater EQ	109
Hue	115

I

Info	118
Information	128, 134
Audio	134
Firmware	134
Notifications	134
Video	134
ZONE	134
Input Assign	120
Input Mode	122
Inputs	119
Input Select	122
Input signal	146
Inputting characters	107
Internet Access	130
IP Control	128
iPod Browse Mode	32
i/p Scaler	117
iTunes	151

L	
Language	132
Lch Level	132
Levels	125
LFE	151
Limit	112
Listening mode	72
Listening position	22
Lock	136
Loudness Management	109
Low Frequency Effects	110
M	
Maintenance Mode	130
MAIN ZONE	151
Manual Setup	124
M-DAX	111
Menu map	103
Mode	111
MP3	151
MPEG	151
MultEQ®	112
Mute Level	112, 132
N	
Network	28, 127
Noise Reduction	115
Notifications	135
Now Playing	118
O	
On Screen Display	118
Output Settings	116
P	
Pairing	151
Pandora®	53, 56
Panel lock function	99
Panorama	110
Pass Through Source	116
Physical Connection	130
Picture Adjust	115
Picture Mode	68, 115

Playback	
ALAC	34, 49
Auto surround	73, 77
Blu-ray Disc player	30
CD player	30
Direct	72, 77
DVD player	30
FLAC	34, 49
Flickr	54
FM/AM	37
Internet Radio	46
iPod (USB)	31
JPEG	34, 49
MP3	34, 46, 49
MPEG-4 AAC	34, 49
NAS	49
Original listening mode	77
Pandora®	56
PC	49
Pure Direct	73, 77
SiriusXM	60
Spotify	62
Stereo	77
USB memory device	34
Video Select	68
WAV	34, 49
WMA	34, 46, 49
ZONE2	101
Power amplifier	90
Power Off Control	116
Power On Level	112
Power On Volume	132
Preset Memory	40
Preset Name	43
Preset Skip	44
Progressive	151
Progressive Mode	117
Protection circuit	151

R	
Random	33, 65
Rch Level	132
Rear panel	140
Reference Level Offset	113
Remote control unit	141
Inserting the batteries	142
Remote lock function	100
Remove from Favorites	67
Repeat	33, 64
Resetting the microprocessor	157
Resolution	117
Router Access	130
S	
Sampling frequency	151
Saturation	115
Save to Favorites	66
Scale	112
Selecting the input source	29
Settings	129
Setup Lock	136
SiriusXM	53, 60
Sleep timer	96, 102
Slideshow	67
Slideshow Interval	67
Sound Mode	72, 144
Source Level	122
Source Rename	122
Speaker	
Connect	81
Install	79
Set up	22, 91
Speaker Config.	124
Speaker impedance	81, 151
Speakers	123
Speaker Selection	113
Spotify	53, 62
Subwoofer	109
Subwoofer Level	109
Subwoofer setting	23
Surr. Back	124
Surround back speaker	79, 80, 83, 85
Surround Parameter	109
sYCC601 color	151

T	
Text Search	64
Tone	111
Tone Control	111
Trademark	143
Treble	111
Trigger Out	133
Troubleshooting	153
Tune Mode	41
Turning off the sound temporarily	30
Turning the power on	29
TV Format	118
U	
Update	135
Usage Data	135
V	
Video	114
Video conversion	6
Video Conversion	116
Video Mode	116
Volume	112, 118
Volume Level	132
Volume Limit	132
vTuner	48, 151
W	
Web control	97
Windows Media DRM	152
Windows Media Player	152
WMA	152
X	
x.v.Color	152
Z	
ZONE2	101, 139, 152
ZONE2 Setup	132
Zone mode setting	23, 91
Zone Rename	132

License

This section describes software license used for this unit. To maintain the correct content, the original (English) is used.

□ Boost

<http://www.boost.org/>

Boost Software License - Version 1.0 - August 17th, 2003

Permission is hereby granted, free of charge, to any person or organization obtaining a copy of the software and accompanying documentation covered by this license (the "Software") to use, reproduce, display, distribute, execute, and transmit the Software, and to prepare derivative works of the Software, and to permit third-parties to whom the Software is furnished to do so, all subject to the following:

The copyright notices in the Software and this entire statement, including the above license grant, this restriction and the following disclaimer, must be included in all copies of the Software, in whole or in part, and all derivative works of the Software, unless such copies or derivative works are solely in the form of machine-executable object code generated by a source language processor.

THE SOFTWARE IS PROVIDED "AS IS", WITHOUT WARRANTY OF ANY KIND, EXPRESS OR IMPLIED, INCLUDING BUT NOT LIMITED TO THE WARRANTIES OF MERCHANTABILITY, FITNESS FOR A PARTICULAR PURPOSE, TITLE AND NON-INFRINGEMENT. IN NO EVENT SHALL THE COPYRIGHT HOLDERS OR ANYONE DISTRIBUTING THE SOFTWARE BE LIABLE FOR ANY DAMAGES OR OTHER LIABILITY, WHETHER IN CONTRACT, TORT OR OTHERWISE, ARISING FROM, OUT OF OR IN CONNECTION WITH THE SOFTWARE OR THE USE OR OTHER DEALINGS IN THE SOFTWARE.

□ Expat

<http://www.jclark.com/xml/expat.html>

Expat License. Copyright (c) 1998, 1999, 2000 Thai Open Source Software Center Ltd

Permission is hereby granted, free of charge, to any person obtaining a copy of this software and associated documentation files (the "Software"), to deal in the Software without restriction, including without limitation the rights to use, copy, modify, merge, publish, distribute, sublicense, and/or sell copies of the Software, and to permit persons to whom the Software is furnished to do so, subject to the following conditions:

The above copyright notice and this permission notice shall be included in all copies or substantial portions of the Software.

THE SOFTWARE IS PROVIDED "AS IS", WITHOUT WARRANTY OF ANY KIND, EXPRESS OR IMPLIED, INCLUDING BUT NOT LIMITED TO THE WARRANTIES OF MERCHANTABILITY, FITNESS FOR A PARTICULAR PURPOSE AND NON-INFRINGEMENT. IN NO EVENT SHALL THE AUTHORS OR COPYRIGHT HOLDERS BE LIABLE FOR ANY CLAIM, DAMAGES OR OTHER LIABILITY, WHETHER IN AN ACTION OF CONTRACT, TORT OR OTHERWISE, ARISING FROM, OUT OF OR IN CONNECTION WITH THE SOFTWARE OR THE USE OR OTHER DEALINGS IN THE SOFTWARE.

□ FastDelegate

<http://www.codeproject.com/KB/cpp/FastDelegate.aspx>

THE WORK (AS DEFINED BELOW) IS PROVIDED UNDER THE TERMS OF THIS CODE PROJECT OPEN LICENSE ("LICENSE"). THE WORK IS PROTECTED BY COPYRIGHT AND/OR OTHER APPLICABLE LAW. ANY USE OF THE WORK OTHER THAN AS AUTHORIZED UNDER THIS LICENSE OR COPYRIGHT LAW IS PROHIBITED.

BY EXERCISING ANY RIGHTS TO THE WORK PROVIDED HEREIN, YOU ACCEPT AND AGREE TO BE BOUND BY THE TERMS OF THIS LICENSE. THE AUTHOR GRANTS YOU THE RIGHTS CONTAINED HEREIN IN CONSIDERATION OF YOUR ACCEPTANCE OF SUCH TERMS AND CONDITIONS. IF YOU DO NOT AGREE TO ACCEPT AND BE BOUND BY THE TERMS OF THIS LICENSE, YOU CANNOT MAKE ANY USE OF THE WORK.

- Definitions.
 - "Articles" means, collectively, all articles written by Author which describes how the Source Code and Executable Files for the Work may be used by a user.
 - "Author" means the individual or entity that offers the Work under the terms of this License.
 - "Derivative Work" means a work based upon the Work or upon the Work and other pre-existing works.
 - "Executable Files" refer to the executables, binary files, configuration and any required data files included in the Work.
 - "Publisher" means the provider of the website, magazine, CD-ROM, DVD or other medium from or by which the Work is obtained by You.
 - "Source Code" refers to the collection of source code and configuration files used to create the Executable Files.
 - "Standard Version" refers to such a Work if it has not been modified, or has been modified in accordance with the consent of the Author, such consent being in the full discretion of the Author.
 - "Work" refers to the collection of files distributed by the Publisher, including the Source Code, Executable Files, binaries, data files, documentation, whitepapers and the Articles.
 - "You" is you, an individual or entity wishing to use the Work and exercise your rights under this License.
- Fair Use/Fair Use Rights. Nothing in this License is intended to reduce, limit, or restrict any rights arising from fair use, fair dealing, first sale or other limitations on the exclusive rights of the copyright owner under copyright law or other applicable laws.

3. License Grant. Subject to the terms and conditions of this License, the Author hereby grants You a worldwide, royalty-free, non-exclusive, perpetual (for the duration of the applicable copyright) license to exercise the rights in the Work as stated below:

- You may use the standard version of the Source Code or Executable Files in Your own applications.
- You may apply bug fixes, portability fixes and other modifications obtained from the Public Domain or from the Author. A Work modified in such a way shall still be considered the standard version and will be subject to this License.
- You may otherwise modify Your copy of this Work (excluding the Articles) in any way to create a Derivative Work, provided that You insert a prominent notice in each changed file stating how, when and where You changed that file.
- You may distribute the standard version of the Executable Files and Source Code or Derivative Work in aggregate with other (possibly commercial) programs as part of a larger (possibly commercial) software distribution.
- The Articles discussing the Work published in any form by the author may not be distributed or republished without the Author's consent. The author retains copyright to any such Articles. You may use the Executable Files and Source Code pursuant to this License but you may not repost or republish or otherwise distribute or make available the Articles, without the prior written consent of the Author.

Any subroutines or modules supplied by You and linked into the Source Code or Executable Files this Work shall not be considered part of this Work and will not be subject to the terms of this License.

- Patent License. Subject to the terms and conditions of this License, each Author hereby grants to You a perpetual, worldwide, non-exclusive, no-charge, royalty-free, irrevocable (except as stated in this section) patent license to make, have made, use, import, and otherwise transfer the Work.
- Restrictions. The license granted in Section 3 above is expressly made subject to and limited by the following restrictions:
 - You agree not to remove any of the original copyright, patent, trademark, and attribution notices and associated disclaimers that may appear in the Source Code or Executable Files.
 - You agree not to advertise or in any way imply that this Work is a product of Your own.
 - The name of the Author may not be used to endorse or promote products derived from the Work without the prior written consent of the Author.
 - You agree not to sell, lease, or rent any part of the Work. This does not restrict you from including the Work or any part of the Work inside a larger software distribution that itself is being sold. The Work by itself, though, cannot be sold, leased or rented.

- You may distribute the Executable Files and Source Code only under the terms of this License, and You must include a copy of, or the Uniform Resource Identifier for, this License with every copy of the Executable Files or Source Code You distribute and ensure that anyone receiving such Executable Files and Source Code agrees that the terms of this License apply to such Executable Files and/or Source Code. You may not offer or impose any terms on the Work that alter or restrict the terms of this License or the recipients' exercise of the rights granted hereunder. You may not sublicense the Work. You must keep intact all notices that refer to this License and to the disclaimer of warranties. You may not distribute the Executable Files or Source Code with any technological measures that control access or use of the Work in a manner inconsistent with the terms of this License.
 - You agree not to use the Work for illegal, immoral or improper purposes, or on pages containing illegal, immoral or improper material. The Work is subject to applicable export laws. You agree to comply with all such laws and regulations that may apply to the Work after Your receipt of the Work.
- Representations, Warranties and Disclaimer. THIS WORK IS PROVIDED "AS IS", "WHERE IS" AND "AS AVAILABLE", WITHOUT ANY EXPRESS OR IMPLIED WARRANTIES OR CONDITIONS OR GUARANTEES. YOU, THE USER, ASSUME ALL RISK IN ITS USE, INCLUDING COPYRIGHT INFRINGEMENT, PATENT INFRINGEMENT, SUITABILITY, ETC. AUTHOR EXPRESSLY DISCLAIMS ALL EXPRESS, IMPLIED OR STATUTORY WARRANTIES OR CONDITIONS, INCLUDING WITHOUT LIMITATION, WARRANTIES OR CONDITIONS OF MERCHANTABILITY, MERCHANTABILITY QUALITY OR FITNESS FOR A PARTICULAR PURPOSE, OR ANY WARRANTY OF TITLE OR NON-INFRINGEMENT, OR THAT THE WORK (OR ANY PORTION THEREOF) IS CORRECT, USEFUL, BUG-FREE OR FREE OF VIRUSES. YOU MUST PASS THIS DISCLAIMER ON WHENEVER YOU DISTRIBUTE THE WORK OR DERIVATIVE WORKS.
 - Indemnity. You agree to defend, indemnify and hold harmless the Author and the Publisher from and against any claims, suits, losses, damages, liabilities, costs, and expenses (including reasonable legal or attorneys' fees) resulting from or relating to any use of the Work by You.
 - Limitation on Liability. EXCEPT TO THE EXTENT REQUIRED BY APPLICABLE LAW, IN NO EVENT WILL THE AUTHOR OR THE PUBLISHER BE LIABLE TO YOU ON ANY LEGAL THEORY FOR ANY SPECIAL, INCIDENTAL, CONSEQUENTIAL, PUNITIVE OR EXEMPLARY DAMAGES ARISING OUT OF THIS LICENSE OR THE USE OF THE WORK OR OTHERWISE, EVEN IF THE AUTHOR OR THE PUBLISHER HAS BEEN ADVISED OF THE POSSIBILITY OF SUCH DAMAGES.

9. Termination.

- a. This License and the rights granted hereunder will terminate automatically upon any breach by You of any term of this License. Individuals or entities who have received Derivative Works from You under this License, however, will not have their licenses terminated provided such individuals or entities remain in full compliance with those licenses. Sections 1, 2, 6, 7, 8, 9, 10 and 11 will survive any termination of this License.
 - b. If You bring a copyright, trademark, patent or any other infringement claim against any contributor over infringements You claim are made by the Work, your License from such contributor to the Work ends automatically.
 - c. Subject to the above terms and conditions, this License is perpetual (for the duration of the applicable copyright in the Work). Notwithstanding the above, the Author reserves the right to release the Work under different license terms or to stop distributing the Work at any time; provided, however that any such election will not serve to withdraw this License (or any other license that has been, or is required to be, granted under the terms of this License), and this License will continue in full force and effect unless terminated as stated above.
10. Publisher. The parties hereby confirm that the Publisher shall not, under any circumstances, be responsible for and shall not have any liability in respect of the subject matter of this License. The Publisher makes no warranty whatsoever in connection with the Work and shall not be liable to You or any party on any legal theory for any damages whatsoever, including without limitation any general, special, incidental or consequential damages arising in connection to this license. The Publisher reserves the right to cease making the Work available to You at any time without notice
11. Miscellaneous
- a. This License shall be governed by the laws of the location of the head office of the Author or if the Author is an individual, the laws of location of the principal place of residence of the Author.
 - b. If any provision of this License is invalid or unenforceable under applicable law, it shall not affect the validity or enforceability of the remainder of the terms of this License, and without further action by the parties to this License, such provision shall be reformed to the minimum extent necessary to make such provision valid and enforceable.
 - c. No term or provision of this License shall be deemed waived and no breach consented to unless such waiver or consent shall be in writing and signed by the party to be charged with such waiver or consent.
 - d. This License constitutes the entire agreement between the parties with respect to the Work licensed herein. There are no understandings, agreements or representations with respect to the Work not specified herein. The Author shall not be bound by any additional provisions that may appear in any communication from You. This License may not be modified without the mutual written agreement of the Author and You.

libogg

<http://www.xiph.org/ogg/>

Copyright (c) 2002, Xiph.org Foundation

Redistribution and use in source and binary forms, with or without modification, are permitted provided that the following conditions are met:

- Redistributions of source code must retain the above copyright notice, this list of conditions and the following disclaimer.
- Redistributions in binary form must reproduce the above copyright notice, this list of conditions and the following disclaimer in the documentation and/or other materials provided with the distribution.
- Neither the name of the Xiph.org Foundation nor the names of its contributors may be used to endorse or promote products derived from this software without specific prior written permission.

THIS SOFTWARE IS PROVIDED BY THE COPYRIGHT HOLDERS AND CONTRIBUTORS "AS IS" AND ANY EXPRESS OR IMPLIED WARRANTIES, INCLUDING, BUT NOT LIMITED TO, THE IMPLIED WARRANTIES OF MERCHANTABILITY AND FITNESS FOR A PARTICULAR PURPOSE ARE DISCLAIMED. IN NO EVENT SHALL THE FOUNDATION OR CONTRIBUTORS BE LIABLE FOR ANY DIRECT, INDIRECT, INCIDENTAL, SPECIAL, EXEMPLARY, OR CONSEQUENTIAL DAMAGES (INCLUDING, BUT NOT LIMITED TO, PROCUREMENT OF SUBSTITUTE GOODS OR SERVICES; LOSS OF USE, DATA, OR PROFITS; OR BUSINESS INTERRUPTION) HOWEVER CAUSED AND ON ANY THEORY OF LIABILITY, WHETHER IN CONTRACT, STRICT LIABILITY, OR TORT (INCLUDING NEGLIGENCE OR OTHERWISE) ARISING IN ANY WAY OUT OF THE USE OF THIS SOFTWARE, EVEN IF ADVISED OF THE POSSIBILITY OF SUCH DAMAGE.

libvorbis

<http://www.xiph.org/vorbis/>

Copyright (c) 2002-2004 Xiph.org Foundation

Redistribution and use in source and binary forms, with or without modification, are permitted provided that the following conditions are met:

- Redistributions of source code must retain the above copyright notice, this list of conditions and the following disclaimer.
- Redistributions in binary form must reproduce the above copyright notice, this list of conditions and the following disclaimer in the documentation and/or other materials provided with the distribution.
- Neither the name of the Xiph.org Foundation nor the names of its contributors may be used to endorse or promote products derived from this software without specific prior written permission.

THIS SOFTWARE IS PROVIDED BY THE COPYRIGHT HOLDERS AND CONTRIBUTORS "AS IS" AND ANY EXPRESS OR IMPLIED WARRANTIES, INCLUDING, BUT NOT LIMITED TO, THE IMPLIED WARRANTIES OF MERCHANTABILITY AND FITNESS FOR A PARTICULAR PURPOSE ARE DISCLAIMED. IN NO EVENT SHALL THE FOUNDATION OR CONTRIBUTORS BE LIABLE FOR ANY DIRECT, INDIRECT, INCIDENTAL, SPECIAL, EXEMPLARY, OR CONSEQUENTIAL DAMAGES (INCLUDING, BUT NOT LIMITED TO, PROCUREMENT OF SUBSTITUTE GOODS OR SERVICES; LOSS OF USE, DATA, OR PROFITS; OR BUSINESS INTERRUPTION) HOWEVER CAUSED AND ON ANY THEORY OF LIABILITY, WHETHER IN CONTRACT, STRICT LIABILITY, OR TORT (INCLUDING NEGLIGENCE OR OTHERWISE) ARISING IN ANY WAY OUT OF THE USE OF THIS SOFTWARE, EVEN IF ADVISED OF THE POSSIBILITY OF SUCH DAMAGE.

Tremolo

<http://wss.co.uk/pinknoise/tremolo>

Copyright (C) 2002-2009 Xiph.org Foundation
Copyright (C) 2009-2010 Robin Watts for Pinknoise Productions Ltd

Redistribution and use in source and binary forms, with or without modification, are permitted provided that the following conditions are met:

- Redistributions of source code must retain the above copyright notice, this list of conditions and the following disclaimer.
- Redistributions in binary form must reproduce the above copyright notice, this list of conditions and the following disclaimer in the documentation and/or other materials provided with the distribution.
- Neither the name of the Xiph.org Foundation nor the names of its contributors may be used to endorse or promote products derived from this software without specific prior written permission.

THIS SOFTWARE IS PROVIDED BY THE COPYRIGHT HOLDERS AND CONTRIBUTORS "AS IS" AND ANY EXPRESS OR IMPLIED WARRANTIES, INCLUDING, BUT NOT LIMITED TO, THE IMPLIED WARRANTIES OF MERCHANTABILITY AND FITNESS FOR A PARTICULAR PURPOSE ARE DISCLAIMED. IN NO EVENT SHALL THE FOUNDATION OR CONTRIBUTORS BE LIABLE FOR ANY DIRECT, INDIRECT, INCIDENTAL, SPECIAL, EXEMPLARY, OR CONSEQUENTIAL DAMAGES (INCLUDING, BUT NOT LIMITED TO, PROCUREMENT OF SUBSTITUTE GOODS OR SERVICES; LOSS OF USE, DATA, OR PROFITS; OR BUSINESS INTERRUPTION) HOWEVER CAUSED AND ON ANY THEORY OF LIABILITY, WHETHER IN CONTRACT, STRICT LIABILITY, OR TORT (INCLUDING NEGLIGENCE OR OTHERWISE) ARISING IN ANY WAY OUT OF THE USE OF THIS SOFTWARE, EVEN IF ADVISED OF THE POSSIBILITY OF SUCH DAMAGE.

Tremor

<http://wiki.xiph.org/index.php/Tremor>

Copyright (c) 2002, Xiph.org Foundation

Redistribution and use in source and binary forms, with or without modification, are permitted provided that the following conditions are met:

- Redistributions of source code must retain the above copyright notice, this list of conditions and the following disclaimer.
- Redistributions in binary form must reproduce the above copyright notice, this list of conditions and the following disclaimer in the documentation and/or other materials provided with the distribution.
- Neither the name of the Xiph.org Foundation nor the names of its contributors may be used to endorse or promote products derived from this software without specific prior written permission.

THIS SOFTWARE IS PROVIDED BY THE COPYRIGHT HOLDERS AND CONTRIBUTORS "AS IS" AND ANY EXPRESS OR IMPLIED WARRANTIES, INCLUDING, BUT NOT LIMITED TO, THE IMPLIED WARRANTIES OF MERCHANTABILITY AND FITNESS FOR A PARTICULAR PURPOSE ARE DISCLAIMED. IN NO EVENT SHALL THE FOUNDATION OR CONTRIBUTORS BE LIABLE FOR ANY DIRECT, INDIRECT, INCIDENTAL, SPECIAL, EXEMPLARY, OR CONSEQUENTIAL DAMAGES (INCLUDING, BUT NOT LIMITED TO, PROCUREMENT OF SUBSTITUTE GOODS OR SERVICES; LOSS OF USE, DATA, OR PROFITS; OR BUSINESS INTERRUPTION) HOWEVER CAUSED AND ON ANY THEORY OF LIABILITY, WHETHER IN CONTRACT, STRICT LIABILITY, OR TORT (INCLUDING NEGLIGENCE OR OTHERWISE) ARISING IN ANY WAY OUT OF THE USE OF THIS SOFTWARE, EVEN IF ADVISED OF THE POSSIBILITY OF SUCH DAMAGE.

Mersenne Twister

<http://www.math.sci.hiroshima-u.ac.jp/~m-mat/MT/MT2002/CODES/mt19937ar.c>

Copyright (C) 1997 - 2002, Makoto Matsumoto and Takuji Nishimura,
All rights reserved.

Redistribution and use in source and binary forms, with or without modification, are permitted provided that the following conditions are met:

1. Redistributions of source code must retain the above copyright notice, this list of conditions and the following disclaimer.
2. Redistributions in binary form must reproduce the above copyright notice, this list of conditions and the following disclaimer in the documentation and/or other materials provided with the distribution.

- The names of its contributors may not be used to endorse or promote products derived from this software without specific prior written permission.

THIS SOFTWARE IS PROVIDED BY THE COPYRIGHT HOLDERS AND CONTRIBUTORS "AS IS" AND ANY EXPRESS OR IMPLIED WARRANTIES, INCLUDING, BUT NOT LIMITED TO, THE IMPLIED WARRANTIES OF MERCHANTABILITY AND FITNESS FOR A PARTICULAR PURPOSE ARE DISCLAIMED. IN NO EVENT SHALL THE COPYRIGHT OWNER OR CONTRIBUTORS BE LIABLE FOR ANY DIRECT, INDIRECT, INCIDENTAL, SPECIAL, EXEMPLARY, OR CONSEQUENTIAL DAMAGES (INCLUDING, BUT NOT LIMITED TO, PROCUREMENT OF SUBSTITUTE GOODS OR SERVICES; LOSS OF USE, DATA, OR PROFITS; OR BUSINESS INTERRUPTION) HOWEVER CAUSED AND ON ANY THEORY OF LIABILITY, WHETHER IN CONTRACT, STRICT LIABILITY, OR TORT (INCLUDING NEGLIGENCE OR OTHERWISE) ARISING IN ANY WAY OUT OF THE USE OF THIS SOFTWARE, EVEN IF ADVISED OF THE POSSIBILITY OF SUCH DAMAGE.

zlib

<http://www.zlib.net/>

zlib.h – interface of the 'zlib' general purpose compression library version 1.2.3, July 18th, 2005

Copyright (C) 1995-2004 Jean-loup Gailly and Mark Adler

This software is provided 'as-is', without any express or implied warranty. In no event will the authors be held liable for any damages arising from the use of this software.

Permission is granted to anyone to use this software for any purpose, including commercial applications, and to alter it and redistribute it freely, subject to the following restrictions:

- The origin of this software must not be misrepresented; you must not claim that you wrote the original software. If you use this software in a product, an acknowledgment in the product documentation would be appreciated but is not required.
- Altered source versions must be plainly marked as such, and must not be misrepresented as being the original software.
- This notice may not be removed or altered from any source distribution.

Jean-loup Gailly jloup@gzip.org, Mark Adler madler@alumni.caltech.edu

cURL

<http://curl.haxx.se>

COPYRIGHT AND PERMISSION NOTICE

Copyright (c) 1996 - 2011, Daniel Stenberg, <daniel@haxx.se>.

All rights reserved.

Permission to use, copy, modify, and distribute this software for any purpose with or without fee is hereby granted, provided that the above copyright notice and this permission notice appear in all copies.

THE SOFTWARE IS PROVIDED "AS IS", WITHOUT WARRANTY OF ANY KIND, EXPRESS OR IMPLIED, INCLUDING BUT NOT LIMITED TO THE WARRANTIES OF MERCHANTABILITY, FITNESS FOR A PARTICULAR PURPOSE AND NONINFRINGEMENT OF THIRD PARTY RIGHTS. IN NO EVENT SHALL THE AUTHORS OR COPYRIGHT HOLDERS BE LIABLE FOR ANY CLAIM, DAMAGES OR OTHER LIABILITY, WHETHER IN AN ACTION OF CONTRACT, TORT OR OTHERWISE, ARISING FROM, OUT OF OR IN CONNECTION WITH THE SOFTWARE OR THE USE OR OTHER DEALINGS IN THE SOFTWARE.

Except as contained in this notice, the name of a copyright holder shall not be used in advertising or otherwise to promote the sale, use or other dealings in this Software without prior written authorization of the copyright holder.

c-ares

<http://c-ares.haxx.se>

Copyright 1998 by the Massachusetts Institute of Technology.

Permission to use, copy, modify, and distribute this software and its documentation for any purpose and without fee is hereby granted, provided that the above copyright notice appear in all copies and that both that copyright notice and this permission notice appear in supporting documentation, and that the name of M.I.T. not be used in advertising or publicity pertaining to distribution of the software without specific, written prior permission. M.I.T. makes no representations about the suitability of this software for any purpose. It is provided "as is" without express or implied warranty.

License Information for the Software Used in the Unit

About GPL (GNU-General Public License), LGPL (GNU Lesser General Public License) License

This product uses GPL/LGPL software and software made by other companies.

After you purchase this product, you may procure, modify or distribute the source code of the GPL/LGPL software that is used in the product.

Marantz provides the source code based on the GPL and LGPL licenses at the actual cost upon your request to our customer service center. However, note that we make no guarantees concerning the source code. Please also understand that we do not offer support for the contents of the source code.

Dimensions

Unit : in. (mm)

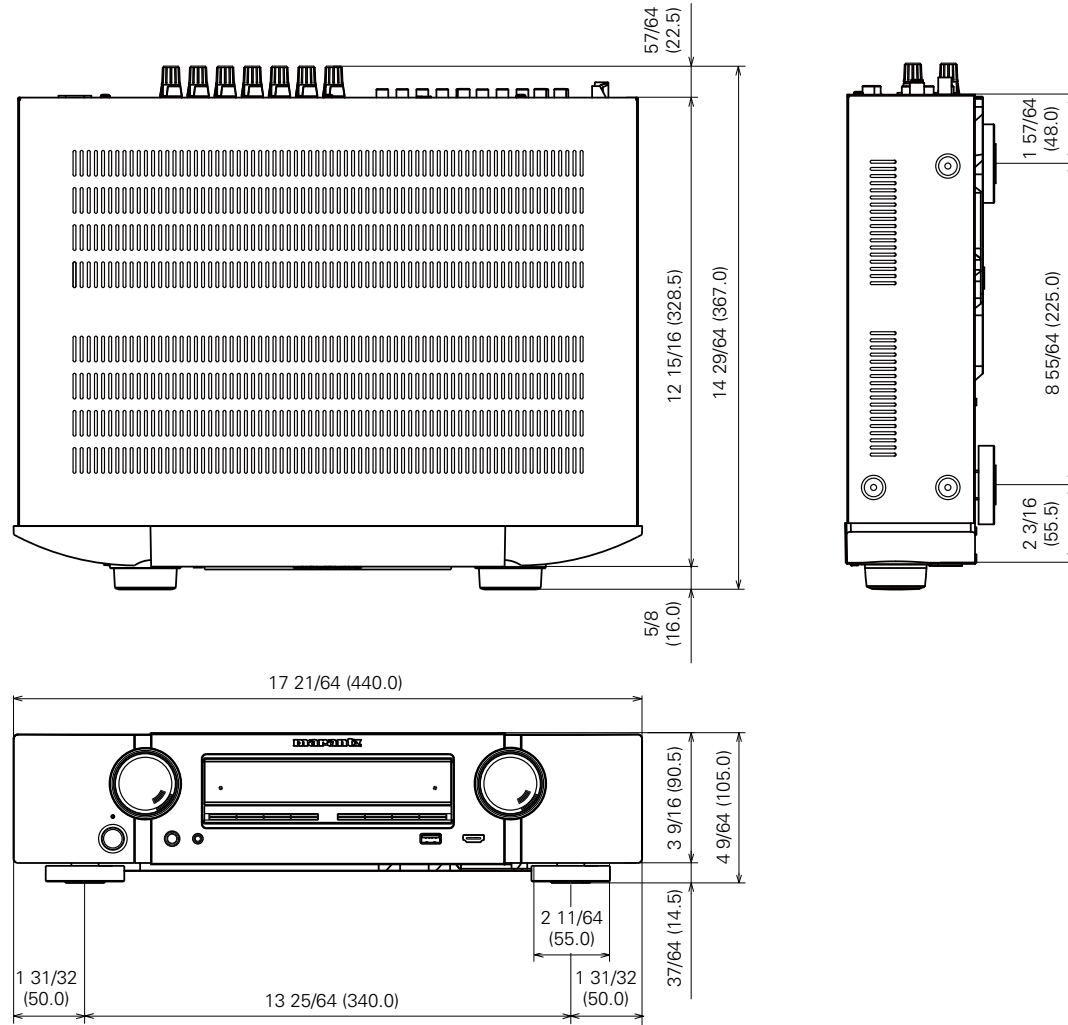

Weight : 18 lbs 8 oz (8.4 kg)

www.marantz.com

You can find your nearest authorized distributor or dealer on our website.

marantz[®] is a registered trademark.